

DEPARTMENT OF THE ARMY TECHNICAL MANUAL

OPERATOR AND ORGANIZATIONAL MAINTENANCE MANUAL
TRUCK, FIRE FIGHTING: POWERED PUMPER,
FOAM AND WATER, 500 GALLONS PER MINUTE CAPACITY,
CENTRIFUGAL PUMP, POWER TAKEOFF DRIVEN,
400 GALLON WATER TANK, 40 GALLON
FOAM CHEMICAL TANK, CLASS 530B,
NONWINTERIZED (WARD LAFRANCE MODEL M45A2WLF),
FSN 4210-928-3515

This copy is a reprint which includes current
pages from Changes 1 through 4.

HEADQUARTERS, DEPARTMENT OF THE ARMY
10 MAY 1968

SAFETY PRECAUTIONS

BEFORE OPERATION

When servicing the battery or refueling, do not smoke or allow open flame nearby. Batteries generate hydrogen, a highly explosive gas. If battery electrolyte is spilled on flesh or clothing wash the affected parts immediately.

Provide sufficient ventilation. Exhaust gases contain carbon monoxide which is colorless, odorless, and deadly poison. Do not lubricate or adjust any assembly or part while the firetruck is operating.

If possible, flush dirt from hydrant before attaching hose.

All fire Extinguishers on the truck are Government furnished equipment. Refer to TM 5-687 for maintenance and refilling.

DURING OPERATION

Keep decks free from oil, grease, ice, and mud to prevent slipping or falling. When operating the firefighting truck water pump, take care to avoid surging conditions in suction and discharge lines. Increase or decrease pressure slowly to avoid danger to personnel. Care must be taken not to touch the muffler with bare hands.

Do not exceed 20 mph on good hard surface roads or 10 mph on secondary roads or across country when towing the fire truck.

AFTER OPERATION

Before doing any work on the electrical system of the firefighting truck, disconnect the ground lead on the batteries.

Make sure equipment is completely deprocessed before servicing. Make sure preservations have been removed from such items as crankcase, fuel tank, gearboxes, and the like.

CHANGE
NO. 4

HEADQUARTERS
DEPARTMENT OF THE ARMY
WASHINGTON, D.C., 10 OCTOBER 1990

Operator and Organizational Maintenance Manual

TRUCK, FIRE FIGHTING: POWDERED PUMPER
FOAM AND WATER, 500 GALLONS PER MINUTE CAPACITY,
CENTRIFUGAL PUMP, POWER TAKEOFF DRIVEN,
400 GALLON WATER TANK; 40 GALLON
FOAM CHEMICAL TANK, CLASS 530B, NONWINTERIZED
(WARD LAFRANCE MODEL M45A2WLF),
FSN 4210-928-3515
AND
(AMERICAN AIR FILTER MODEL FT-500),
FSN 4210-449-0431

Approved for public release; distribution is unlimited

TM 5-4120-213-12, 10 May 1968, is changed as follows:

Page 2-2, Paragraph 2-4.a. Add the following note.

NOTE

Electrolyte (NSNs 6810-00-249-9354 and 6810-00-843-1640) has a specific gravity of 1.280 and should be used in these batteries. Do NOT adjust the electrolyte in wet batteries to a lower specific gravity.

Page 2-24, Paragraph 2-19. Add the following paragraph:

c. Batteries. The batteries will perform properly as long as electrolyte levels are carefully monitored. Increase PMCS (TM 9-2320-209-10).

Page 3-40, Paragraph 3-76. Add the following note:

NOTE

The 6TN and 6TL batteries can be mixed or matched. However, maintenance-free batteries cannot be mixed or matched with military batteries. The 6TN and or the 6TL batteries will perform properly in hot weather as long as electrolyte levels are carefully monitored. If the electrolyte expands and causes the level to rise, some fluid must be removed. If the level becomes too low due to evaporation, distilled water may be used to obtain the proper level. A good grade of drinking water (excluding mineral waters) may be used if distilled water is not available.

By Order of the Secretary of the Army:

CARL E. VUONO
General, United States Army
Chief of Staff

Official:

THOMAS F. SIKORA
Brigadier General, United States Army
The Adjutant General

DISTRIBUTION:

To be distributed in accordance with DA Form 12-25E, (qty rqr block no.1975)

Changes in force: C1, C2 and C3

**TM 5-4210-213-12
C3**

CHANGE

HEADQUARTERS
DEPARTMENT OF THE ARMY
WASHINGTON, D.C., 11 April 1988

No. 3

Operator and Organizational Maintenance Manual

TRUCK, FIRE FIGHTING: POWERED PUMPER
FOAM AND WATER, 500 GALLONS PER MINUTE CAPACITY,
CENTRIFUGAL PUMP, POWER TAKEOFF DRIVEN,
400 GALLON WATER TANK, 40 GALLON
FOAM CHEMICAL TANK, CLASS 530B,
NONWINTERIZED (WARD LAFRANCE MODEL M45A2WLF),
FSN 4210-928-3515

TM 5-4210-213-12, 10 May 1968, is changed as follows:

Page 1-1. Paragraph 1-1.d. Change U.S. Army Mobility Equipment Command, ATTN: AMSME-MPP, 4300 Goodfellow Boulevard., St. Louis, Missouri 63120 to read: Commander, USA TROSCOM, ATTN: AMSTR-MCTS, 4300 Goodfellow Boulevard, St. Louis, Missouri 63120-1798.

Page 2-2. Section II. Add the following subparagraphs after paragraph 2-6d.

e. Placement of equipment in administrative storage should be for short periods of time when a shortage of maintenance effort exists. Items should be in mission readiness within 24 hours or within the time factors as determined by the directing authority. During the storage period, appropriate maintenance records will be kept.

f. Before placing equipment in administrative storage, current maintenance services and equipment serviceable criteria (ESC) evaluations should be completed, shortcomings and deficiencies should be corrected, and all modification work orders (MWO's) should be applied.

g. Storage site selection. Inside storage is preferred for items selected for administrative storage.

Page B-3. Section II. BASIC ISSUE ITEMS, Column (2), Federal Stock Number, line 15. Change "4910-789-0452" to "4910-204-2547."

Page B-3. Section II. BASIC ISSUE ITEMS, Column (2), Federal Stock Number, line 17. Change "5120-233-7398" to "5120-223-7398."

Page B-3, Section II. BASIC ISSUE ITEMS column (2), Federal Stock Number, line 52. Change "2640-052-0944" to "2640-060-3550."

Page B-3/ Section II. BASIC ISSUE ITEMS, Column (2), Federal Stock Number, line 57. Change "2530-738-9621" to "2530-026-0265."

Page B-4. Section II. BASIC ISSUE ITEMS, Column (2), Federal Stock Number, line 7. Change "5120-493-3152" to "5120-293-1289."

By Order of the Secretary of the Army:

CARL E. VUONO
General, United States Army
Chief of Staff

Official:

R. L. DILWORTH
Brigadier General, United States Army
The Adjutant General

DISTRIBUTION:

To be distributed in accordance with Da Form 12-25A, Operator and Unit Maintenance requirements for Truck, Fire Fighting, Power Pumper, 400 GAL Water/40 GAL Foam, (M454 A2WLF, FT-500, M45A2FTL-1).

Change }
No. 2 }

HEADQUARTERS
DEPARTMENT OF THE ARMY
Washington, D.C., 13 July 1973

**Operator's and Organizational Maintenance Manual
TRUCK, FIRE FIGHTING: POWERED PUMPER,
FOAM AND WATER, 500 GALLONS PER MINUTE CAPACITY,
CENTRIFUGAL PUMP, POWER TAKEOFF DRIVEN,
400-GALLON WATER TANK; 40-GALLON
FOAM CHEMICAL TANK, CLASS 530B, NONWINTERIZED
(WARD LAFRANCE MODEL M45A2WLF), FSN 4210-928-3515
AND
(AMERICAN AIR FILTER MODEL FT-500), FSN 4210-449-0431**

TM 5-4210-213-12, 10 May 1968, is changed as follows:

2-2.1. Maintenance and Operating Supplies

Page 2-1. Paragraph 2-2.1 is added after paragraph 2-2.

The maintenance and operating supplies required for the initial eight hours of operation are shown in table 2-1.1.

Table 2-1.1.Maintenance and Operating Supplies.

(1) Component application	(2) Federal stock number	(3) Description	(4) Quantity required for initial operation	(5) Quantity required for 8 hrs operation	(6) Notes
TRANSMISSION ASSY, FIRE PUMP	9150-577-5845	OIL, LUBRICATING: GO 90 or (2) GOS (2)	2 qt 2 qt	(1) (1)	(1) See current LO for grade application and replenishment intervals. (2) See C9100-IL for additional data and requisitioning procedure.
TANK PRIMING PUMP. GREASE POINTS	9150-190-0904 (2)	OIL, LUBRICATING GREASE, AUTOMOTIVE AND ARTILLERY: 1 lb can as follows: GAA	6 qt	(1)	
FOAM TANK	4210-223-9877	FOAM, LIQUID, FIRE EXTINGUISHING: 5 gal pail Fed. Spec. 0-F] 555.	as req 40 gal	(1)	

NOTE

See TM 9-2320-209-10 for Maintenance and Operating Supplies applicable to the 2½-ton 6x6 Model M45A2 Truck Chassis.

**APPENDIX B
BASIC ISSUE ITEM LIST AND ITEMS
TROOP INSTALLED OR AUTHORIZED LIST**

Section I. INTRODUCTION

B-1. Scope

This appendix lists basic issue items and items troop installed or authorized which accompany the fire truck and are required by the crew/operator for operation, installation, or operator's maintenance.

The following provides an explanation of columns in the tabular list of items troop installed or authorized, section III.

*a. Source, Maintenance, and Recoverability Code(s) (SMR):*Not applicable.

B-2. General

This basic issue items and items troop installed or authorized lists are divided into the following sections:

b. Federal Stock Number. This column indicates the Federal stock number assigned to the item which will be used for requisitioning purposes.

a. Basic Issue Items List-Section II. Not applicable.

c. Description. This column indicates the Federal item name and any additional description of the item required.

b. Items Troop Installed or Authorized List-Section III. A list in alphabetical sequence of items which, at the discretion of the unit commander, may accompany the end item, but are not subject to be turned in with the end item.

d. Unit of Measure (U/M). A 2-character alphabetic abbreviation indicating the amount or quantity of the item upon which the allowances are based: e.g., ft. ea, pr: etc.

B-3. Explanation of Columns

e. Quantity Authorized. This column indicates the quantity of the item authorized to be used with the equipment.

Section III. ITEMS TROOP INSTALLED OR AUTHORIZED LIST

(1) SMR code	(2) Federal stock No.	(3) Description	(4) Unit of meas	(5) Qty auth
	5140-772-4142	BAG, TOOL, SACHEL	ea	1
	7520559-9618	CASE, MAINTENANCE AND OPERATION MANUALS	ea	1
	4720-092-9264	HOSE ASSEMBLY, RUBBER	ea	1
	4910-204-2547	INFLATOR, GAGE	ea	1
	5120-223-7398	PLIERS, COMBINATION, SLIP JOINT	ea	1
	5120-234-8913	SCREWDRIVER, CROSS TIP	ea	1
	5120-240-8716	SCREWDRIVER, CROSS TIP	ea	1
	2520-222-8852	SCREWDRIVER, FLAT TIP	ea	1
	5120-449-8083	WRENCH, OPEN END, ADJUSTABLE	ea	1

By Order of the Secretary of the Army:

CREIGHTON W. ABRAMS
General, United States Army
Chief of Staff

Official:

VERNE L. BOWERS
Major General, United States Army
The Adjutant General

Distribution:

To be distributed in accordance with DA Form 12-25A, (qty rqr block No. 122) Organizational Maintenance Requirements for Fire Fighting Equipment.

CHANGE

HEADQUARTERS
DEPARTMENT OF THE ARMY
WASHINGTON, D. C., 22 March 1971

No. 1

Operator and Organizational Maintenance Manual

**TRUCK, FIRE FIGHTING: POWERED PUMPER,
FOAM AND WATER, 500 GALLONS PER MINUTE CAPACITY,
CENTRIFUGAL PUMP, POWER TAKEOFF DRIVEN,
400 GALLON WATER TANK; 40 GALLON
FOAM CHEMICAL TANK, CLASS 530B, NONWINTERIZED
(WARD LAFRANCE MODEL M45A2WLF), FSN 4210-928-3515
AND
(AMERICAN AIR FILTER MODEL FT-500), FSN 4210-449-0431**

TM 5-4210-213-12, 10 May 1968, is changed as follows:

Title is changed as shown above.

Page i Contents, Chapter 3, Section VI. Change "Radio interference suppression" to read "Radio interference suppression (M45A2WLF)."

Page 1-1 Paragraph 1-~~a~~ is superseded as follows:

a. These instructions and the instructions contained in TM's 9-2320-209-10 and 9-2320-209-20 are published for use by the personnel to whom the Ward LaFrance Model M45A2WLF and the American Air Filter Model FT-500 fire trucks are issued. *Paragraph 1-3a* In line two, change "1-1 and 1-2" to read "1-1, 1-2, 1-2A and 1-2B."

Page 1-2. Figures 1-2A and 1-2B are added as follows:

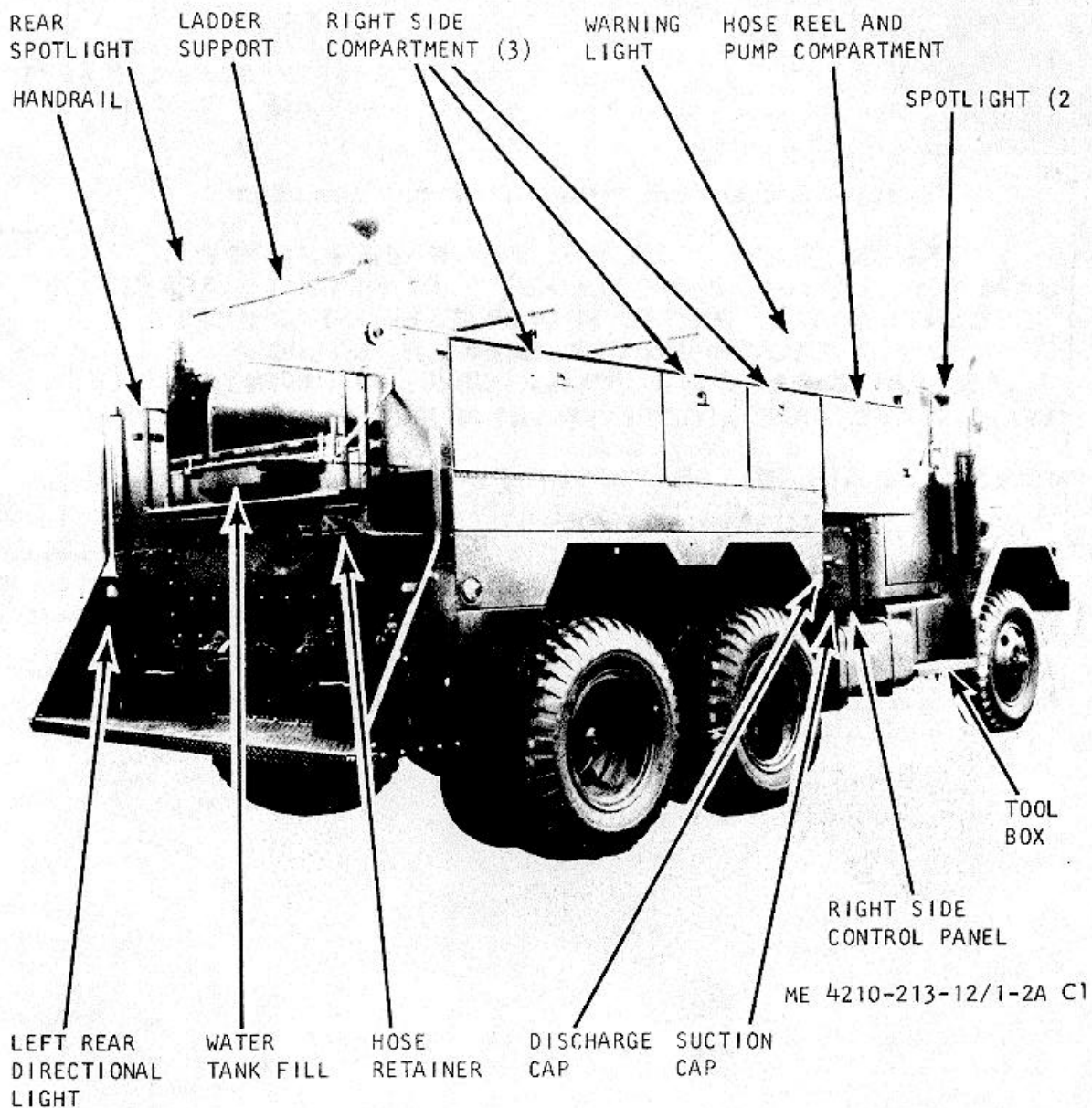

SHIPPING DIMENSIONS		
LENGTH	272	INCHES
WIDTH	100	INCHES
HEIGHT	109	INCHES
WEIGHT	16,300	POUNDS

Figure 1-2A. Fire truck, model FT-500, right-rear, three-quarter view with shipping dimensions.

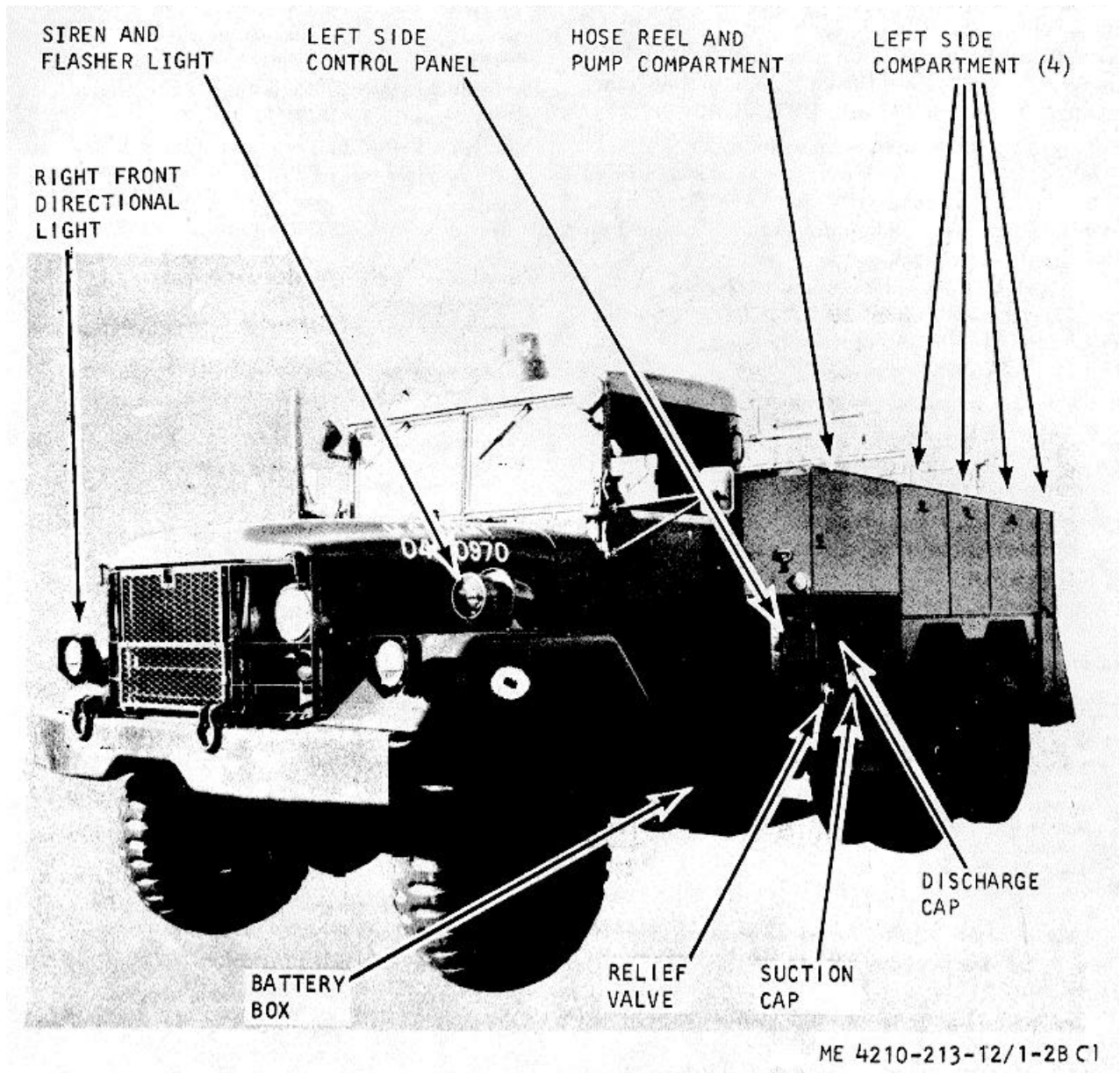

Figure 1-2B. Fire truck, model FT-500, left-front, three-quarter view.

Page 1-3, paragraph 1-3a. Delete the last sentence.
Paragraph 1-3b. In line five, change "TT-E529" to read "MIL-T-704."; in line six, change "R and U" to read "repair and utilities"; and in line nine, change "TT-E489" to read "MI;ITr-704 'C-
Paragraph 1-4 is superseded as follows:

a. *Identification.* The fire trucks, model M45A2WLF and model FT-500 have three major identification plates. The information contained on the plates is listed below.

Paragraph 1-4(1). Title is changed to read:

(1) *Fire truck model M-45A2WLF.* Paragraph 1-4b(1.1) is added as follows:

(1.1) Fire truck model FT-500.

ManufacturerAmerican Air Filter Co. Inc., Defense Products Group

ModelFT-500

Type.....Nonwinterized

Class (military).....530B.

Paragraph 1-4(2)(c). Title is changed to read:

(c) *Batteries, lead-acid, two in series (model M45A2 WLF).*

Paragraph 1-4(2)(c.1) is added as follows:

(c.1) *Batteries, lead-acid, four in series-parallel, (model FT-500).*

Manufacturer.....Prestolite Company, Division of Eltra Corporation

Model6TRN-US

Type (SAE).....6TN

Military Standard

Number.....MS35000-3

Voltage (each).....12 v.

Ampere-hour rating

(at 20 hour rate).....100

Ground.....Negative

Paragraph 1-4(2)(d). Change "Model 1113-1" to read "Models 1113-1 (M45A2WLF) and 1113-2 (FT-500)."

Paragraph 1-4(3). In line three, after "Centrifugal" add, "single-stage."

Page 1-4, Paragraph 1-4(3). After "Power source" add:

Ratio.....1:2.28

Paragraph 1-4(3)(b). After "Model" add:

Type.....Moisture/Fungus Resistant

Paragraph 1-4(3)(f). Change "Model HD" to read

"Model.....HD (M45A2WLF) and DV9 (FT-500)"

Paragraph 1-4(4) is superseded as follows:

(4) *Foam proportioning system (M45A2WLF).*

Paragraph 1-4(4.1) is added as follows:

(4.1) *Foam proportioning system (FT-500).*

Manufacturer.....Bliss and Portland, Division of E. W. Bliss Co.

Model.....B-2

Kit No.....S-4521

Type.....Around-the-pump

Solution.....Foam and water

Paragraph 1-4(5). Title is changed to read:

(5) *Hose reel (M45A2.WLF).*

Paragraph 1-4(5.1) is added as follows:

(5.1) *Hose reel (FT-500).*

Manufacturer.....Clifford B. Hannay and Sons

Models.....EFP32-19-20-RT and

EFP32-19-20-LT

Type.....Manual orelectric rewind

Outlet connection

(male).....1 inch diameter, 8 threads per inch

Motor data:

Manufacturer.....Ohio Elec. Co.

Model.....1134-1X4876

Horsepower.....¼

Voltage dc.....24 v.

Amperes.....36 amp

Revolutions per

minute.....530 rpm

Rotation.....Counterclockwise or clockwise

Time rating.....5 minutes

Paragraph 1-4(6). Title is changed to read:

(6) *Siren (M45A2WLF).*

Paragraph 1-4(6.1) is added as follows:

(6.1) *Siren (FT-500).*

Manufacturer.....Federal Sign and Signal Corp.

ModelWW4L29G70

Type.....With flasher light

Voltage.....24 vdc

Amperes.....10 amp

Lamp.....4880

Candlepower.....6000

Paragraph 1-4(8)(a). Title is changed to read:

(a) *Front spotlight (M45A2WLF).*

Paragraph 1-4(8)(a.1) is added as follows:

(a.1) *Front spotlight (FT-500).*

Manufacturer.....Unity Manufacturing Co.

ModelS-6

Type.....225

Voltage.....24 vdc

Amperes.....5 amp

Candlepower.....75,000

Lamp.....4530

Paragraph 1-4(10). Change "model" to read:

Models.....HV220024 (M45A2WLF) and HV211794 (FT 500)

Page 1-5, paragraph 1-4(11). Title is changed to read:

(11) *Tachometer (M45A2WLF).*

Paragraph 1-4(11.1) is added as follows:

(11.1) *Tachometer (FT-500).*

Figure 2-1A is added as follows:

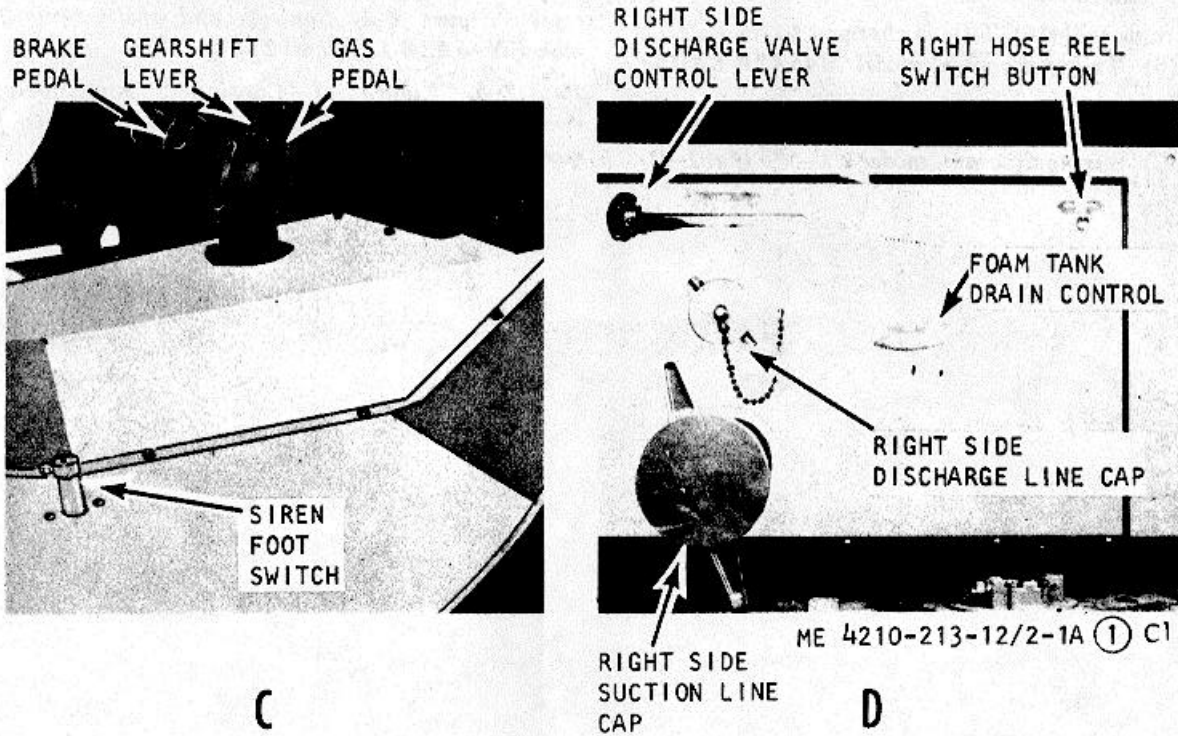
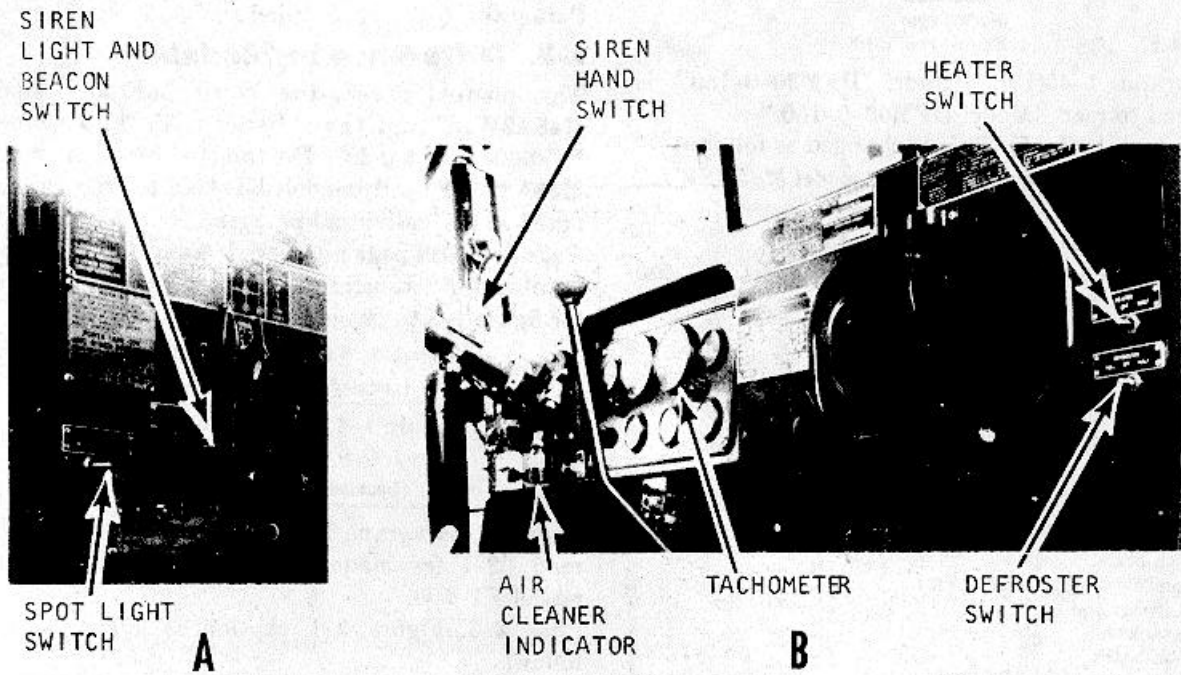

Figure 2-1A. Controls and instruments for model FT-500 (Sheet 1 of 3).

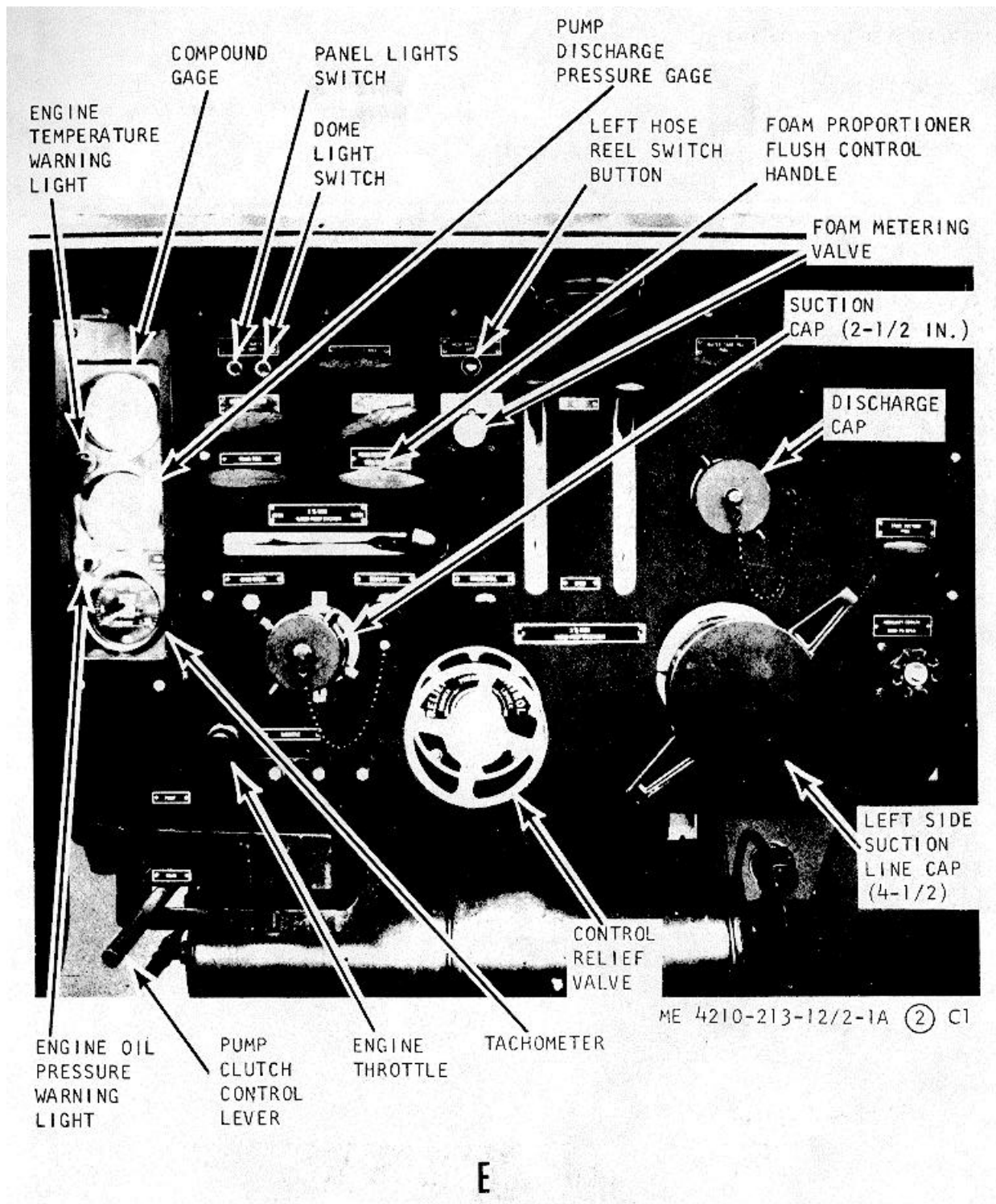

Figure 2-1A. Controls and instruments for model FT-500 (sheet 2 of 3).

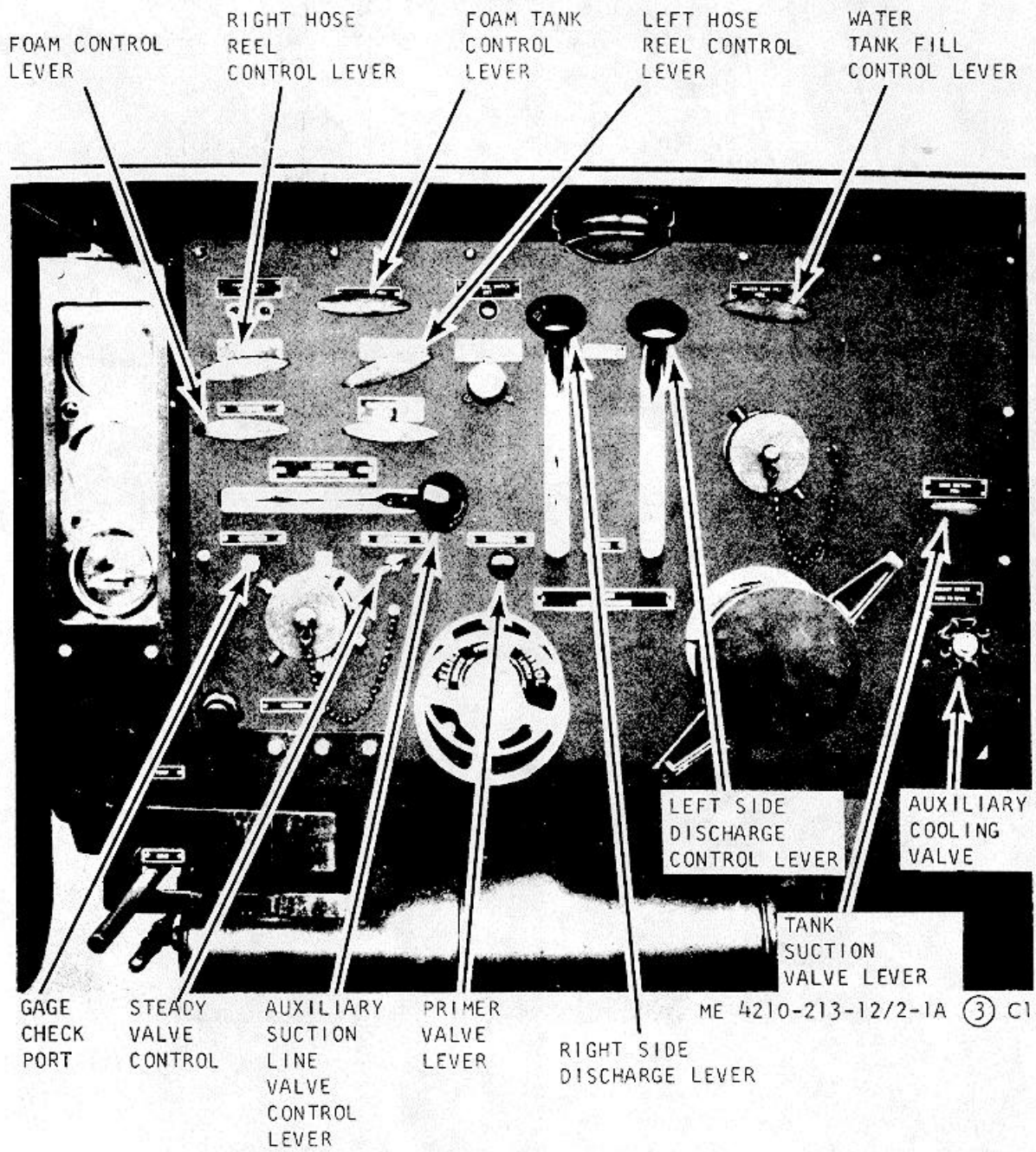

Figure 2-1A. Controls and instruments for model FT-500 (sheet 3 of 3).

Page 2-6, paragraph 2-13. In. line 2, change "figure 2-3" to read "figure 2--2A and 2--3."

Paragraph 2-13, line 2. Change "figure 2--5" to read "figure 2-4A and 2-5."

Paragraph 2-13, line 2. Change "figure 2-6, 2-7" to read "2-6, 2-7 or 2-7A".

Paragraphs 2-14 and 2-14(3). Change "figure 2-8" to read "figures 2-7B or 2-8".

Paragraph 2-14. Change "figure 2-9" to read "figures 2-9 and 2-9A".

Paragraph 2-14. Change "figure 2-11" to read "figures 2-10A and 2-11".

Paragraphs 2-15 and 2-15. Change "figure 2-12" to read "figures 2-12 and 2-12A".

Page 2-7. After **figure 2-2. Priming pump details** add **(sheet 1 of 6)**!

Page 2-8, figure 2-2. Change caption to read **Figure 2-2. Priming pump details for model M45A2WLF (sheet 2 of 6)**!

Figure 2-2 (sheet 3 of 6) is added as follows:

DRAINING

PULL OUT ON LEVER UNTIL ALL LIQUID
IS DRAINED FROM LINES AND PUMP

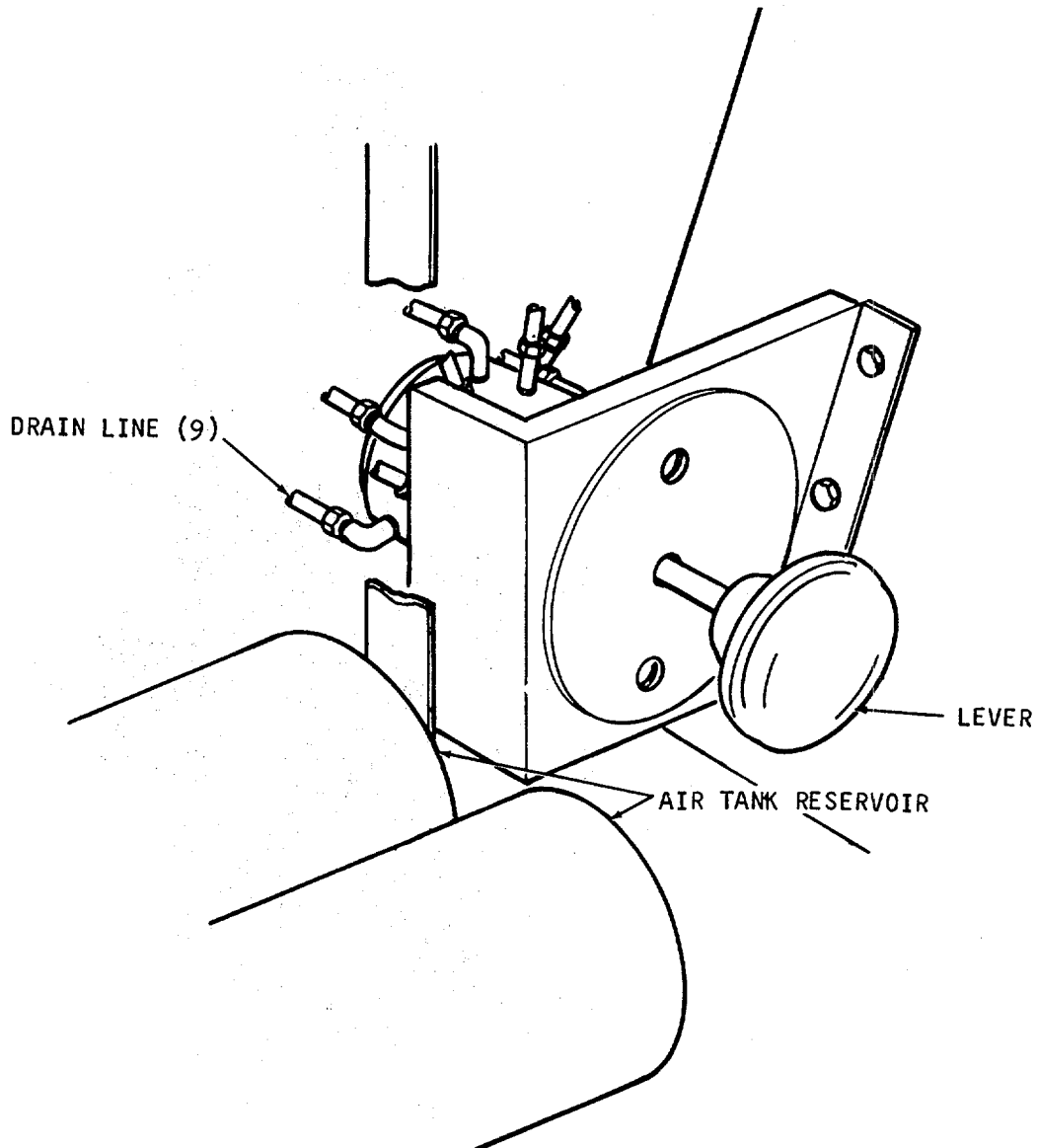

PRIMING FROM SUCTION LIFT

1. MAKE SURE THE DRAIN VAULES ARE IN A CLOSED POSITION
2. CLOSE LINE DRAIN VALVE

NOTE

TO CLOSE VALVE, PUSH IN ON LEVER

Page 2-9, figure 2-2. Change caption to read **Figure 2-2. Priming pump details (sheet 4 of 6)**

Page 2-10, figure 2--2. Change caption to read **Figure 2-2. Priming pump details for model M45A2 WLF (sheet 5 of 6).**

Figure 2-2 (sheet 6 of 6) is added as follows:

7. ALL CONTROLS AND VALVES SHOULD BE IN CLOSED POSITION.
8. REMOVE SUCTION CAPS FROM LEFT OR RIGHT SIDE AS DESIRED AND ATTACH ONE END OF THE SUCTION ROSE TO FIRE PUMP SUCTION INLET AND PLACE APPROPRIATE END WITH STRAINER ATTACHED IN WATER.

NOTE

WHEN USING THE 2-1/2 INCH SUCTION, OPEN THE AUXILIARY SUCTION LINE VALVE LEVER.

CAUTION

SEE THAT THE STRAINER AT LOWER END OF HOSE IS AT LEAST 2 FEET BELOW WATER SURFACE TO AVOID TAKING AIR BUT FAR ENOUGH FROM BOTTOM TO PREVENT PUMPING SAND AND OTHER FOREIGN MATERIAL.

9. PULL PRIMER VALVE LEVER ALL THE WAY OUT. HOLD IN POSITION UNTIL DISCHARGE HOSE IS FREE OF AIR AND WATER STARTS TO DISCHARGE.

CAUTION

IF PRIMING PUMP DOES NOT DISCHARGE WATER IN 10 TO 30 SECONDS PUSH PRIMER VALVE LEVER IN AND LOOK FOR AIR LEAKS.

NOTE

RIGHT HAND DISCHARGE VALVE CAN BE OPERATED FROM EITHER LEFT OR RIGHT HAND OPERATORS CONTROL PANEL.

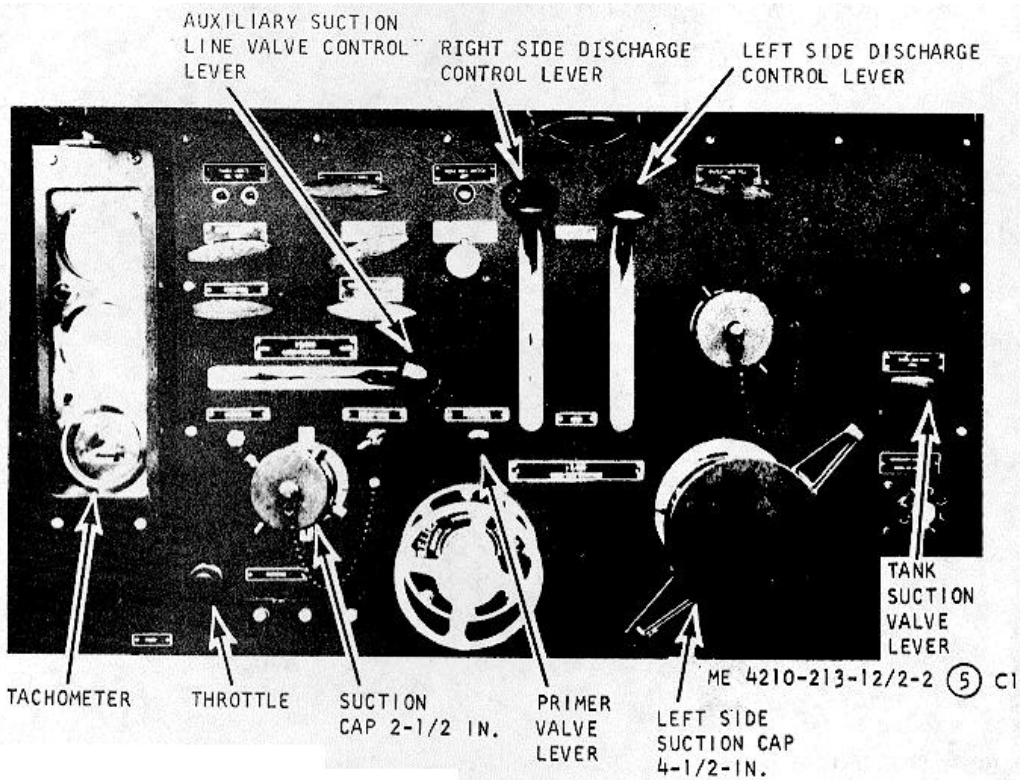

PRIMING FROM WATER TANK:

1. OPEN TANK SUCTION VALVE LEVER
2. CONTINUE AS IN STEPS 1 THRU 9 ABOVE EXCEPT OMIT STEP 8.

PRIMING FROM HYDRANT:

1. REMOVE DESIRED SUCTION CAPS AND CONNECT ONE END OF HOSE WITH STRAINER TO SUCTION LINE AND OTHER END WITH HYDRANT.
2. CONTINUE AS IN STEPS 1 THRU 7 (PRIMING FROM SUCTION LIFT ABOVE).

NOTE

DO NOT PULL PRIMER VALVE LEVER. PRESSURE FROM HYDRANT WILL FORCE WATER INTO PUMP.

3. OPEN HYDRANT

E(FT-500)

Figure 2-2. Priming pump details for model FT-500 (sheet 6 of 6).

Figure 2-2A is added as follows:

1. MAKE SURE ALL VALVES AND CONTROLS ARE IN CLOSED POSITION.
2. OPEN THE WATER TANK FILL COVER AT REAR OF TANK.
3. PRIME THE WATER PUMP FROM SUCTION LIFT (FIG. 2-2).
4. MOVE PUMP CLUTCH CONTROL LEVER FROM ROAD TO PUMP POSITION.
5. FILL THE WATER TANK BY OPENING THE TANK FILL CONTROL LEVER.

NOTE

TANK OVERFLOW IS ON FRONT LEFT CORNER OF TANK WITH DISCHARGE PIPE RUNNING UNDER THE TRUCK.

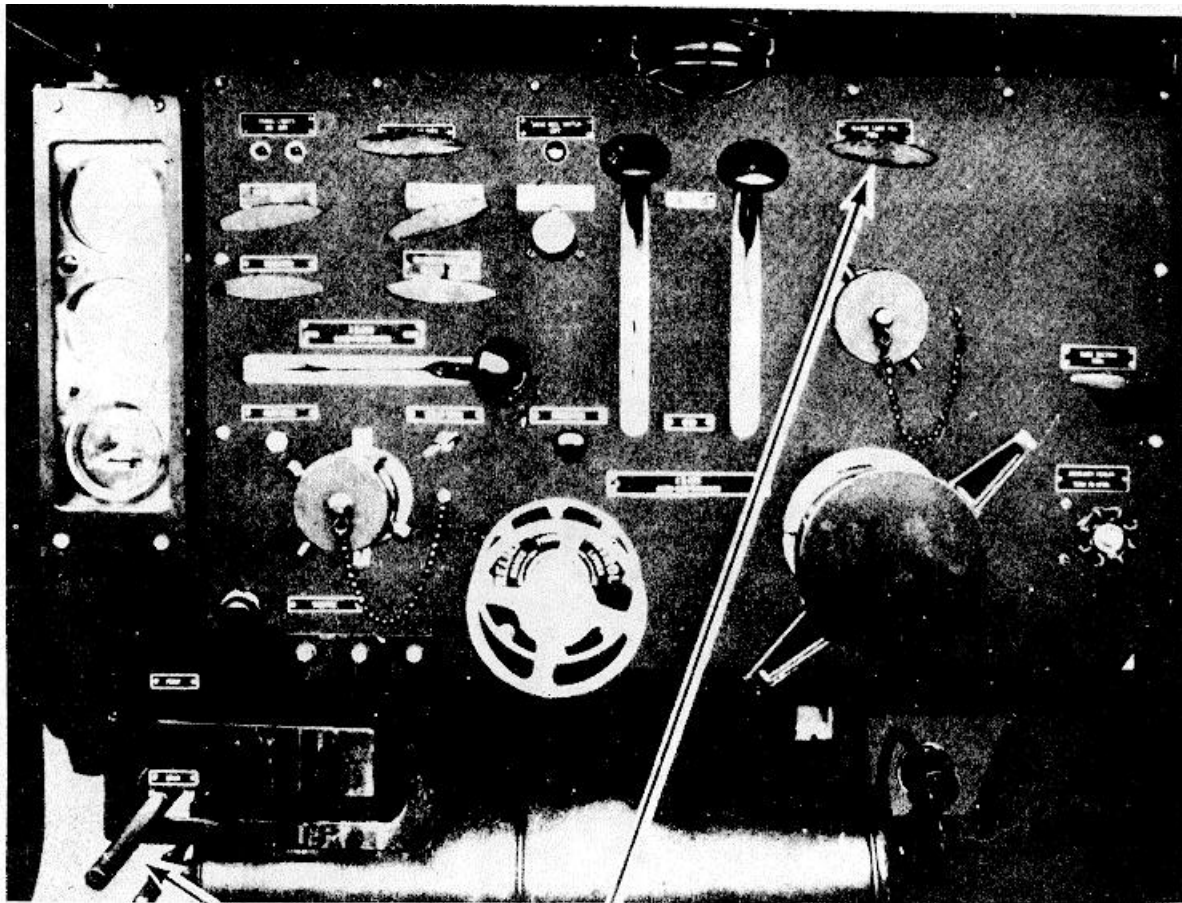

PUMP
CLUTCH
CONTROL
LEVER

WATER TANK FILL
CONTROL LEVER

ME 4210-213-12/2-2A C1

CAUTION

THE PUMP CLUTCH CONTROL LEVER MUST BE IN THE ROAD POSITION WHEN WATER IS NOT BEING DISCHARGED.

Figure 2-2A. Filling water tank from suction lift (FT-500)

1. MAKE SURE DRAIN VALVES AND CONTROL VALVE LEVERS ARE CLOSED.
2. RELEASE LATCH AND OPEN FILL BOX COVER.
3. CONNECT SUCTION HOSES BETWEEN PUMP SUCTION INLET AND HYDRANT.
4. OPEN HYDRANT.
5. OPEN TANK FILL AND SUCTION VALVE LEVERS.

NOTE

IF A 2-1/2 INCH AUXILIARY SUCTION IS USED THE AUXILIARY SUCTION LINE VALVE CONTROL LEVER MUST ALSO BE OPENED.

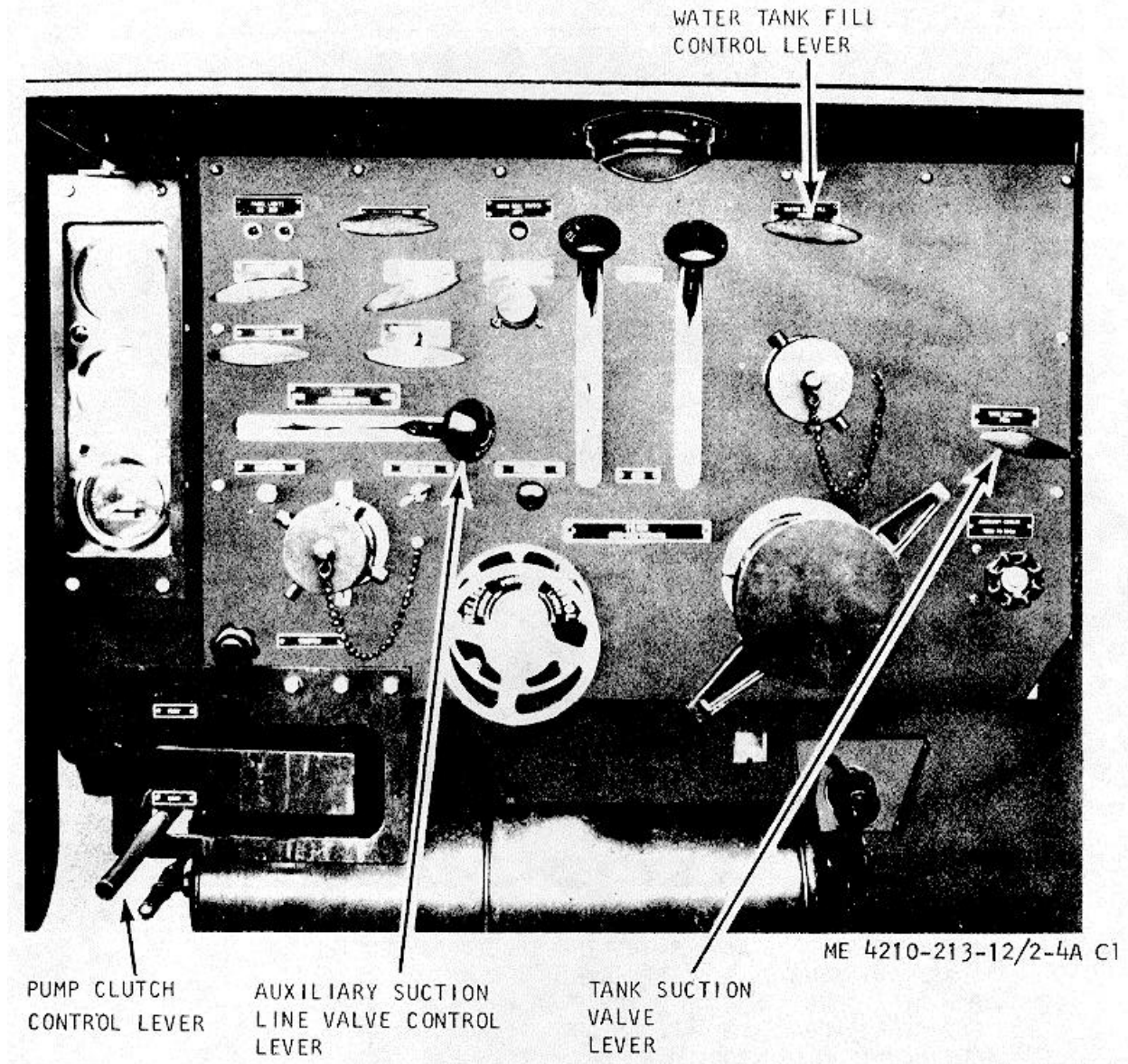

CAUTION

THE PUMP CLUTCH CONTROL LEVER MUST BE IN THE ROAD POSITION. WHEN WATER IS NOT BEING DISCHARGED.

Figure 2-4A. Filling water tank from hydrant for model FT-500.

Page 2-13. Change figure caption to read **Figure 2-5.**
Filling water tank from hydrant for model M45A2WLF.

Page 2-16. Change figure caption to read **Figure 2-7.**
Foam system. flushing for model M45A2WLF" Figures
2-7A and 2-7B are added as follows:

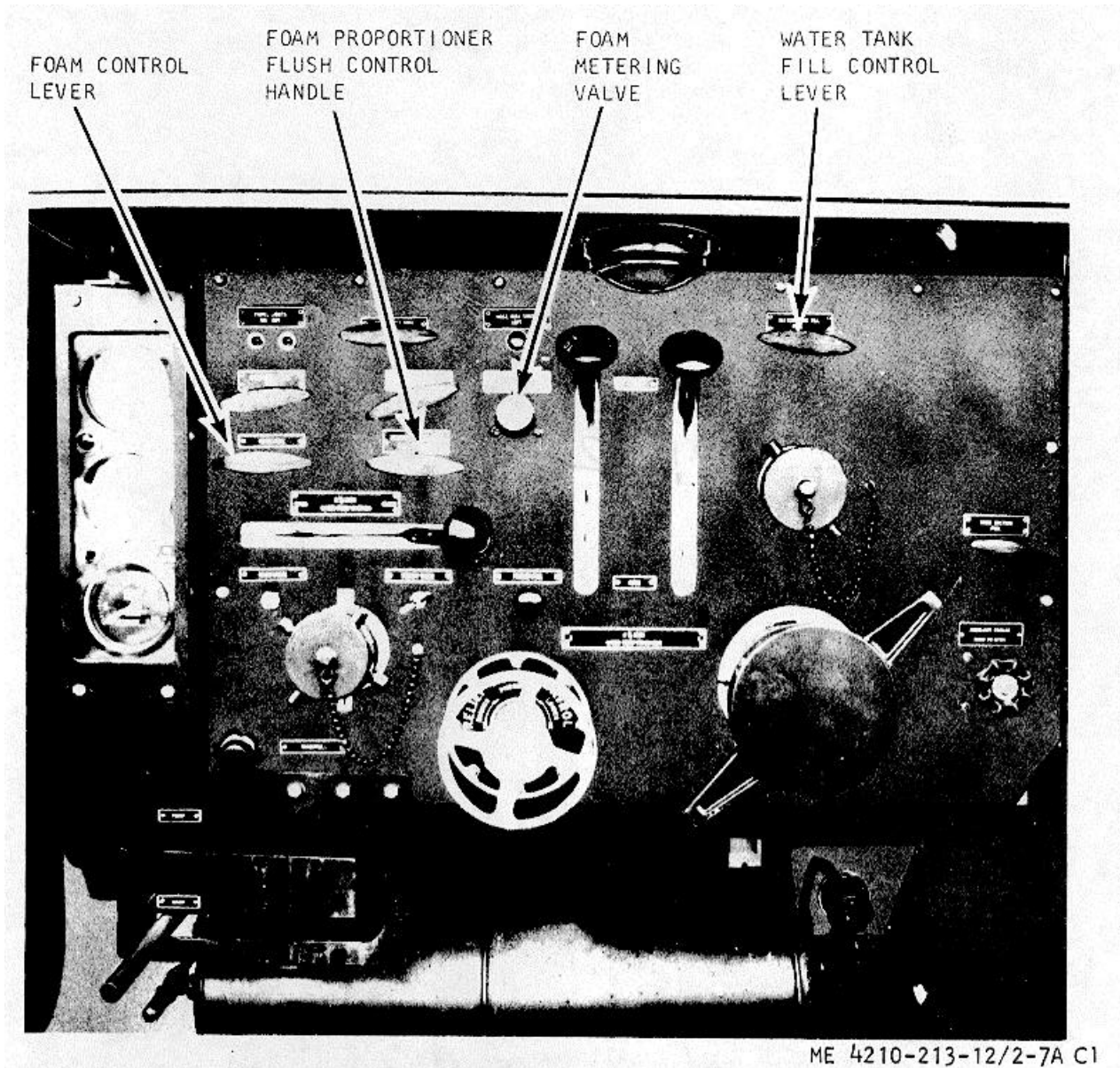

1. SET UP TO PUMP IN ANY OF THE THREE METHODS MENTIONED (DRAFT, HYDRANT OR BOOSTER TANK.)
2. OPEN DISCHARGES THROUGH WHICH FOAM HAD BEEN PUMPED.
3. OPEN FOAM PROPORTIONER FLUSH-OUT VALVE.
4. CONTINUE TO DISCHARGE WATER UNTIL FOAM HAS BEEN COMPLETELY FLUSHED FROM SYSTEM.

NOTE
FOAM METERING VALVE MUST BE OPEN TO ALLOW FLUSHING OF SYSTEM.

Figure 2-7A. Foam system flushing for model FT-500.

1. WATER MAY BE PUMPED EITHER INDEPENDENTLY TO ONE, OR TO ALL OF THE OUTLETS AFTER REMOVING THE DISCHARGE CAPS AND CONNECTING HOSES.
2. GET AS CLOSE TO WATER AS POSSIBLE.
3. PRIME THE WATER PUMP FROM SUCTION LIFT (FIG. 2-2) NOTE: MAKE SURE RELIEF VALVE WHEEL IS SCREWED OUT TO LESS THAN 100 PSI.
4. MOVE PUMP CLUTCH CONTROL LEVER FROM ROAD TO PUMP POSITION AND OPEN DISCHARGE VALVE OR VALVES.
5. OPEN THROTTLE GRADUALLY UNTIL DESIRED DISCHARGE PRESSURE IS REACHED AND REGULATE AUXILIARY COOLING VALVE TO COOL ENGINE.
6. SET RELIEF VALVE BY WATCHING PUMP DISCHARGE PRESSURE GAGE AND SCREW IN WHEEL UNTIL PRESSURE INCREASES AND DESIRED PRESSURE IS RESTORED.

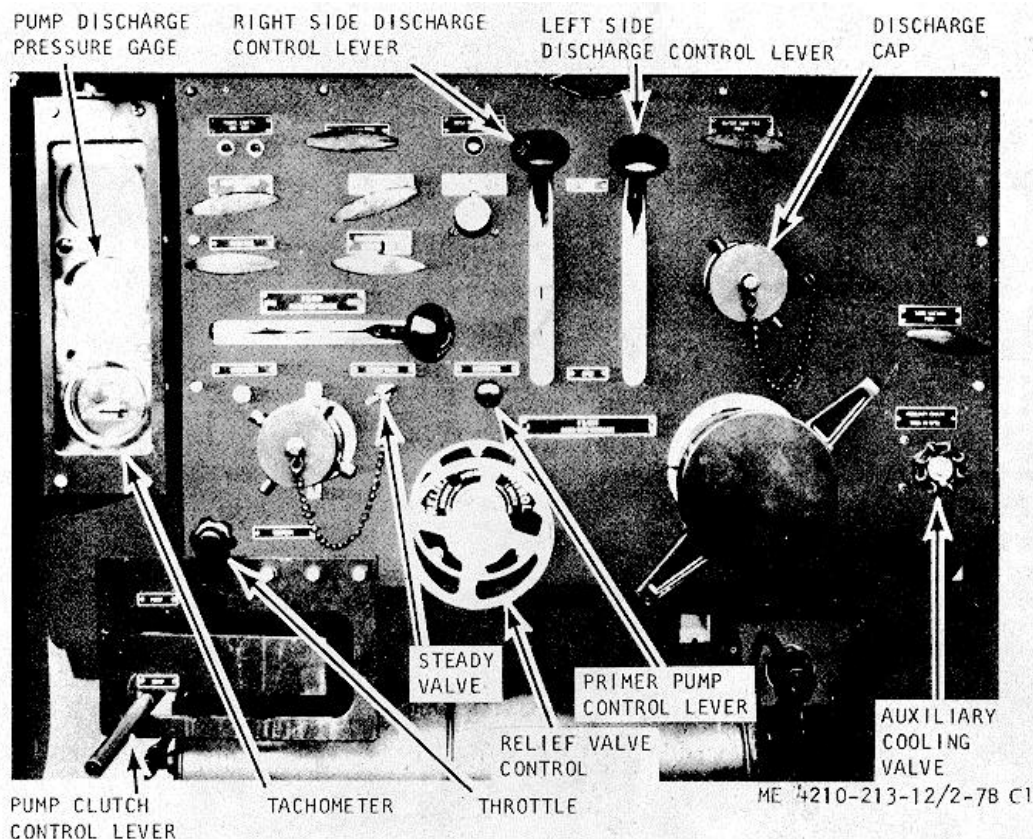

7. IF WATER SHOULD CONTINUE TO FLOW OUT PRIMING PUMP DISCHARGE AFTER MAIN PUMP IS RUNNING, FLUSH PRIMING VALVE BY PULLING AND RELEASING PRIMING PUMP CONTROL LEVER SEVERAL TIMES.
8. IF FOR CHANGING HOSE OR FOR ANY OTHER REASON A SHUT-DOWN IS DESIRED WHEN WORKING FROM LIFT, SIMPLY SLOW DOWN TO ABOUT 20 POUNDS ON ORDINARY LIFTS AND 35 POUNDS ON HIGH LIFTS AND CLOSE DISCHARGE VALVES. TO RESUME SIMPLY OPEN THE DISCHARGE VALVES AND THROTTLE AND RESET RELIEF VALVE.

WARNING

USE OF A NOZZLE TOO SMALL FOR THE PRESSURE CAN RUPTURE THE HOSE.

WARNING

WHEN WATER IS BEING PUMPED THROUGH THE DISCHARGE SYSTEM, AT LEAST TWO MEN SHOULD CONTROL THE HOSE AT THE NOZZLE TO PREVENT THE HOSE FROM WHIPPING AND CAUSING SERIOUS INJURY.

Figure 2-7B. Pumping water from suction lift for model FT-500.

Page 2-17. Change figure caption to read **Figure 2-8. Pumping water from suction lift for model M45A2WLF.**"

Page 2-18. Change figure caption to read **Figure 2-9. Pumping water from hydrant for model M45A2WLF.**"

Figure 2-9A is added as follows:

1. WATER MAY BE PUMPED EITHER INDEPENDENTLY TO ONE OR TO ALL OF THE OUTLETS AFTER REMOVING THE DISCHARGE CAPS AND CONNECTING HOSES.
2. OPEN HYDRANT TO PRIME PUMP (FIG. 2-2).
3. MOVE PUMP CLUTCH CONTROL LEVER FROM ROAD TO PUMP POSITION, AND OPEN DISCHARGE VALVE OR VALVES.
4. OPEN THROTTLE GRADUALLY UNTIL DESIRED DISCHARGE PRESSURE IS REACHED AND REGULATE AUXILIARY COOLING VALVE TO COOL ENGINE.
5. SET RELIEF VALVE BY WATCHING PRESSURE GAGE AND BACKING OUT WHEEL UNTIL PRESSURE DROPS. THEN SCREW IN UNTIL ORIGINAL PRESSURE IS RESTORED.

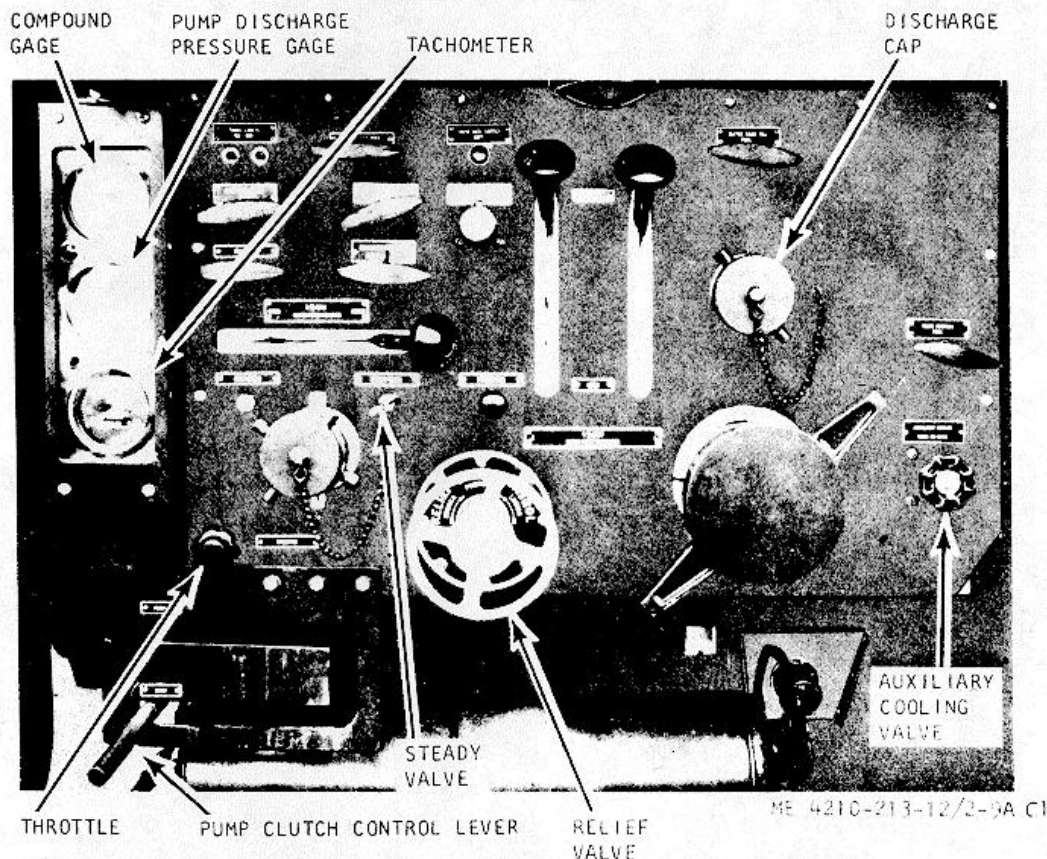

6. WATCH PRESSURE GAGE AS THROTTLE IS OPENED. IF ENGINE SPEED INCREASES WITHOUT PRESSURE GOING UP, YOU'VE PASSED THE MOST EFFICIENT POINT OF OPERATION. CLOSE THROTTLE SLOWLY UNTIL THE PRESSURE BEGINS TO DROP AND THE ENGINE SPEED BECOMES REASONABLE.

CAUTION

MAKE SURE THE COMPOUND GAGE DOES NOT REGISTER BELOW 0 PSI SERIOUS DAMAGE TO WATER MAINS MAY RESULT.

7. IF COMPOUND GAGE SHOWS VACUUM BEFORE DESIRED PRESSURE IS REACHED, THIS IS AN INDICATION THAT PUMP IS DRAWING ALL THE WATER HYDRANT, WILL SUPPLY. USE SMALLER TIPS TO OBTAIN MORE PRESSURE.

NOTE

USE STEADY VALVE TO REMOVE FLUCTUATIONS IN THE PUMP DISCHARGE PRESSURE GAGE.

Figure 2-9A. Pumping water from hydrant for model FT-500.

Page 2-19. Change figure caption to read *Figure 2-10. Pumping water from the hose reels (sheet 1 of 3).*"

Page 2-20. Change figure caption to read *Figure 2-10. Pumping water from the hose reels for model M45A2WLF (sheet 2 of 3).*"
Figure 2-10 (3 of 3) is added as follows:"

4. MOVE PUMP CLUTCH CONTROL LEVER FROM ROAD TO PUMP POSITION.
5. OPEN THROTTLE UNTIL DESIRED PRESSURE IS REACHED AND REGULATE AUXILIARY COOLING VALVE TO COOL ENGINE.
6. PULL OUT ON THE LEFT HOSE REEL CONTROL LEVER.

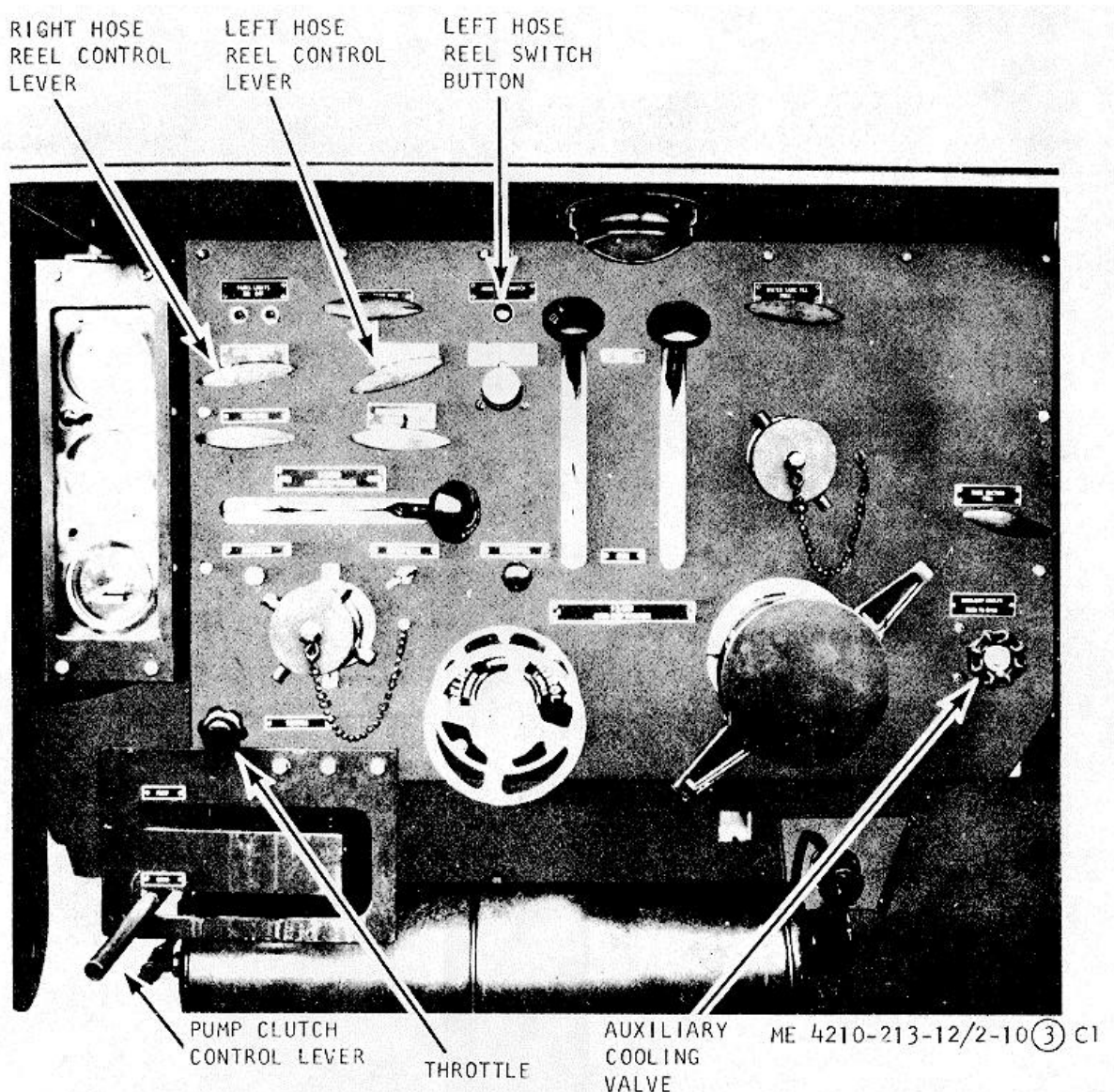

7. AFTER PUMPING IS COMPLETE DRAIN THE HOSE, AND REWIND ON REEL BY PUSHING LEFT HOSE REEL SWITCH BUTTON.

NOTE
PUMP WATER FROM THE RIGHT HOSE REEL IN A SIMILAR MANNER.

NOTE
IN CASE OF FAULTY HOSE REEL MOTOR OR ELECTRICAL SYSTEM, HOSE REEL CAN BE OPERATED MANUALLY WITH THE HANDCRANK.

8. LOCK HOSE REEL BY TURNING LOCK KNOB CLOCKWISE.
- C(FT-500)**

Figure 2-10. Pumping water from the hose reels for model FT-500 (sheet 3 of 3).

Figure 2-10A is added as follows:

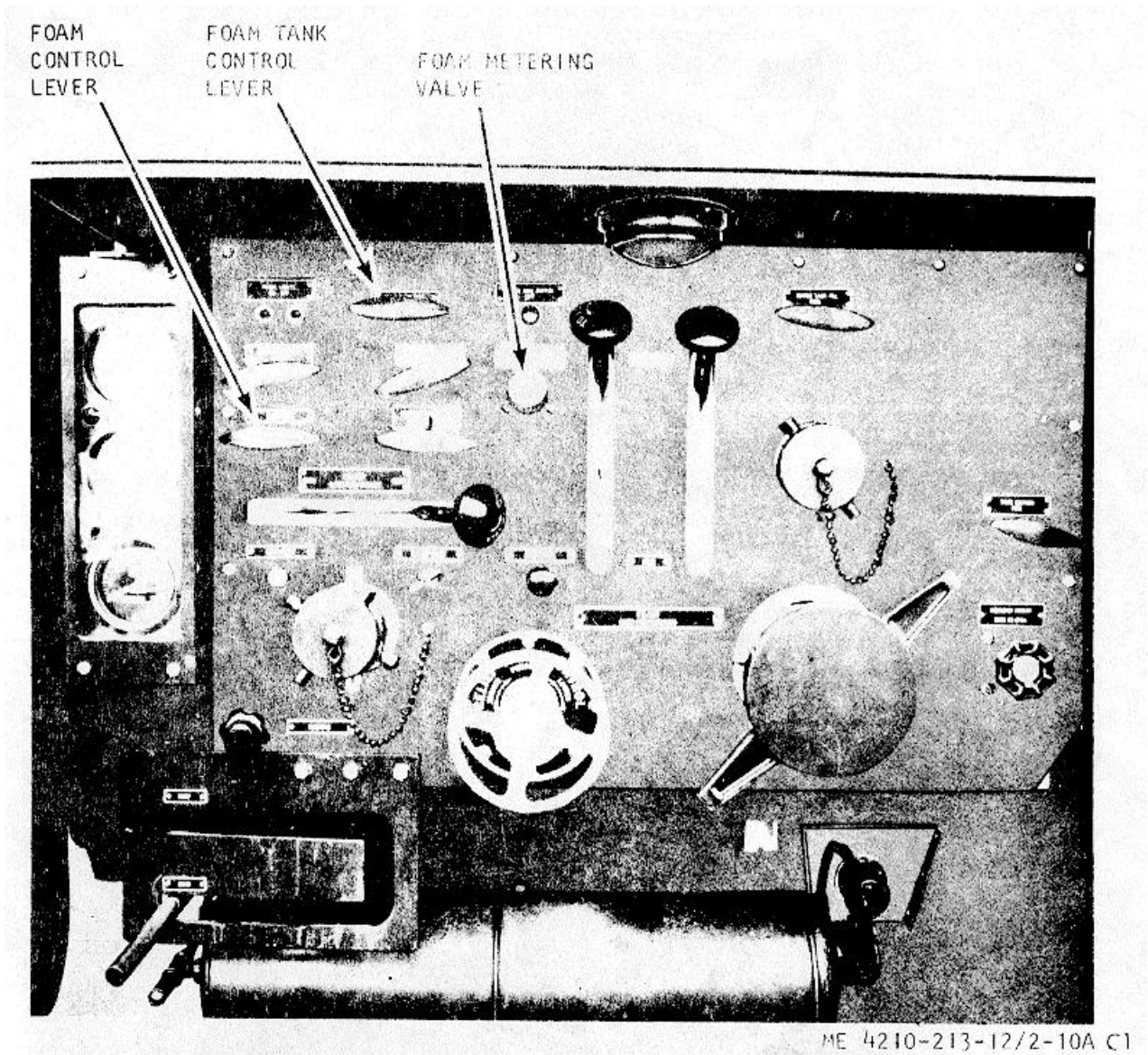

1. FILL THE FOAM TANK (FIG. 2-6).
2. PRESET THE METERING FOAM VALVE IN ACCORDANCE WITH FOAM METERING PLATE.
3. PREPARE THE PUMP FOR OPERATION IN ONE OF THE METHODS OUTLINED IN (PARA. 2-14).
4. OPEN THE FOAM TANK CONTROL LEVER.
5. OPEN THE FOAM CONTROL LEVER.
6. PUMP WATER AND FOAM FROM THE PUMP DISCHARGE LINE.
7. AFTER USE DRAIN AND FLUSH THE SYSTEM (FIG. 2-12A)

Figure 2-10A. Pumping foam for model FT-500.

Page 2-21. Change figure caption to read "Figure 2-11. Pumping foam for model M45A2WLF."

Page 2-22. Change figure caption to read "Figure 2-12. Draining and flushing foam concentrate tank and discharge line system for model M45A2WLF."

Figure 2-12A is added as follows:

DRAINING AND FLUSHING FOAM TANK:

1. CLOSE THE FOAM VALVE.
2. OPEN THE FOAM TANK DRAIN VALVE (FIG. 2-6).
3. MANUALLY RUN A SUFFICIENT QUANTITY OF WATER THROUGH THE TANK TO FLUSH THE REMAINING FOAM CONCENTRATE FROM THE TANK. CLOSE FOAM TANK DRAIN VALVE.

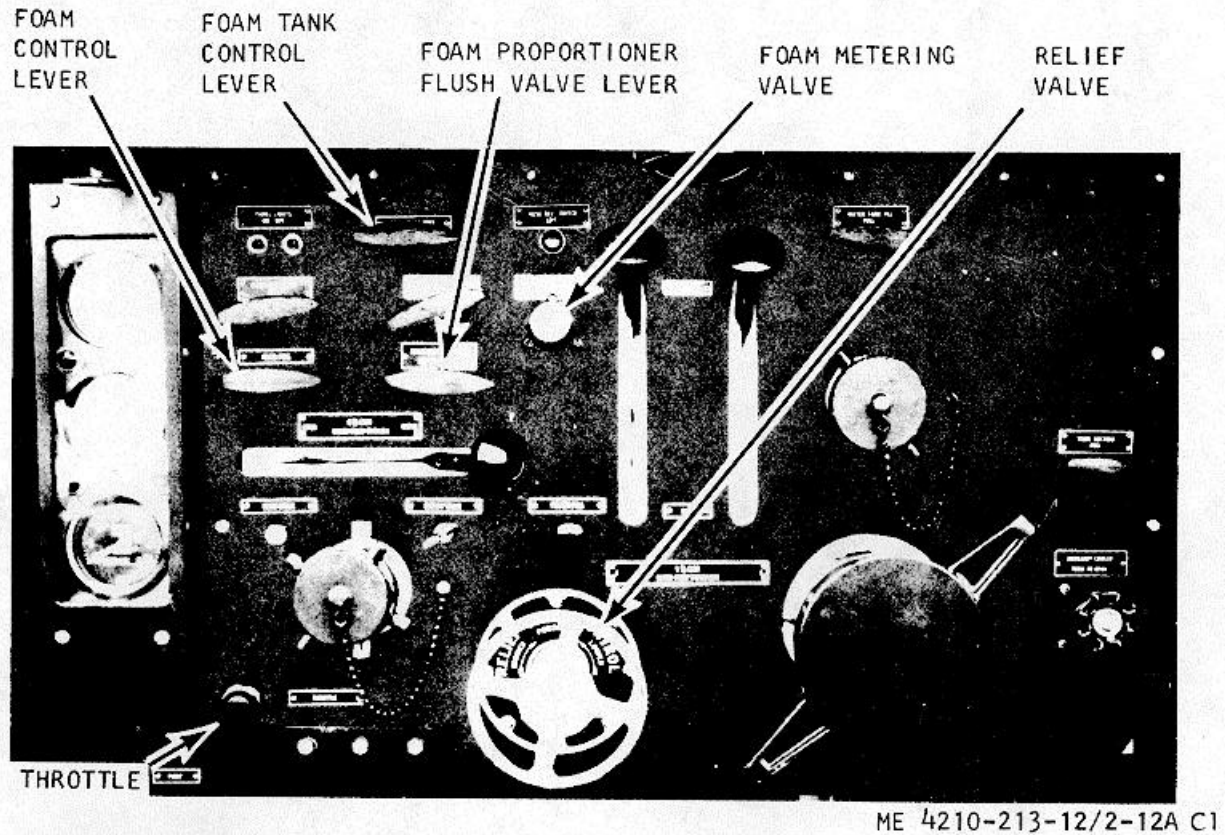

FLUSHING DISCHARGE LINE SYSTEM:

1. START ENGINE (PARA. 2-11) AND REDUCE ENGINE SPEED WITH THROTTLE
2. REDUCE PRESSURE IN RELIEF VALVE BY TURNING VALVE WHEEL COUNTERCLOCKWISE.
3. WITH FOAM VALVE CLOSED OPEN FOAM METERING VALVE TO MAXIMUM.
4. OPEN FOAM FLUSH VALVE (KEEP FOAM VALVE CLOSED) AND PUMP WATER AS DESCRIBED IN FIG. 2-10A.
5. ALLOW WATER TO RUN THROUGH THE SYSTEM UNTIL FOAM IS DEPLETED.
6. SHUT UNIT DOWN.
7. OPEN THE WATER PUMP AND LINES DRAIN VALVE (FIG. 2-2).

NOTE

ALWAYS FLUSH THE FOAM SYSTEM AS SOON AS IT IS DRAINED UNLESS IT IS TO BE IMMEDIATELY REFILLED. IF THE FOAM SYSTEM IS NOT FLUSHED, DAMAGE WILL RESULT AND RENDER THE SYSTEM INOPERATIVE.

Figure 2-12A. Draining and flushing foam concentrate and discharge line system for model FT-500.

Page 2-23, figure 2-13. Change "PERCENTAGE OF EFFICIENCY VS RATED HORSEPOWER" to read "PERCENTAGE OF EFFICIENCY AT RATED HORSEPOWER."

Page 3-1. Paragraph 3-~~3~~ is superseded as follows:

b. Refer to DA Pamphlet 3104 for the current lubrication order for the fire truck.

Page 3-2. Figure 3-1 is rescinded.

Page 3-3. Figure 3-1 is rescinded.

Page 3-4. Figure 3-1 is rescinded.

Pages 3-5 and 3-7, figures 3-2 and 3-3. After "WARD LAFRANCE MODEL M45A2WLF" add "AND AMERICAN AIR FILTER MODEL FT-500".

Page 3-10, section IV. Title is changed to read "RADIO INTERFERENCE SUPPRESSION FOR MODEL M45A2WLF".

Page 3-11, figure 3-4. Caption is changed to read "Radio interference suppression components for model M45A2WLF."

Page 3-12, paragraph 3-25. Change "left side compartments." to read "left side compartments on model M45A2WLF fire truck. On the model FT-500 fire truck, the four ladder brackets are installed on the inboard sides of both the left and right side compartments."

Paragraph 3-25. After last sentence add "In addition, a protective panel is provided for the water tank insulation on model FT-500 fire truck."

Pages 3-12 and 3-13. In paragraphs 3-26 through 3-31 wherever "figure 3-5" appears, change to read, "figures 3-5 or 3-5A".

Page 3-13. Paragraph 3-31.1 is added as follows:

3-31.1 Protective Panel Model FT-500

a. *Removal.* Refer to figure 3-5A and remove the protective panel.

b. Cleaning, Inspection and Repair.

(1) Clean all parts with dry cleaning solvent P-D-680, and dry thoroughly.

(2) Inspect all parts for damage or defective condition.

(3) Replace or repair damaged or defective parts as necessary.

c. *Installation.* Refer to figure 3-5A and install the protective panel.

Paragraphs 3-32 through 3-35. Wherever "figure 3-6" appears, change to read "figures 3-6 or 3-6A".

Paragraph 3-36: Change "figure 3-7" to read "figures 3-6B or 3-7" two places.

Page 3-14. Paragraph 3-37, lines 8 through 11 are changed to read "On model M45A2WLF the battery box is located on the right front cab step, and houses two 12 volt batteries. On model FT-500 the battery box is located on the left front cab step and houses four 12 volt batteries. On model M45A2WLF fire truck, an oil pan heater adapter is mounted under the oil pan."

Paragraph 3-42. Title is changed as follows:

3-42. Oil Pan Heater Adapter for Model M45A2WLF

Page 3-15, paragraphs 3-43a and e. Change "figure 3-13" to read "figures 3-12A and 3-13".

Paragraphs 3-4~~3~~ and d. Change "figure 3-14" to read "figures 3-12B and 3--14".

Paragraphs 3-4~~4~~ and c. Change "figure 3-16" to read "figures 3-15A and 3-16".

Page 3-16. Figure 3-5 caption is changed to read "*Hose bed assemblies, handrails, rear step, tool box door, and brackets, removal and installation for model M45A2WLF.*"

Figure 3-5A is added as follows:

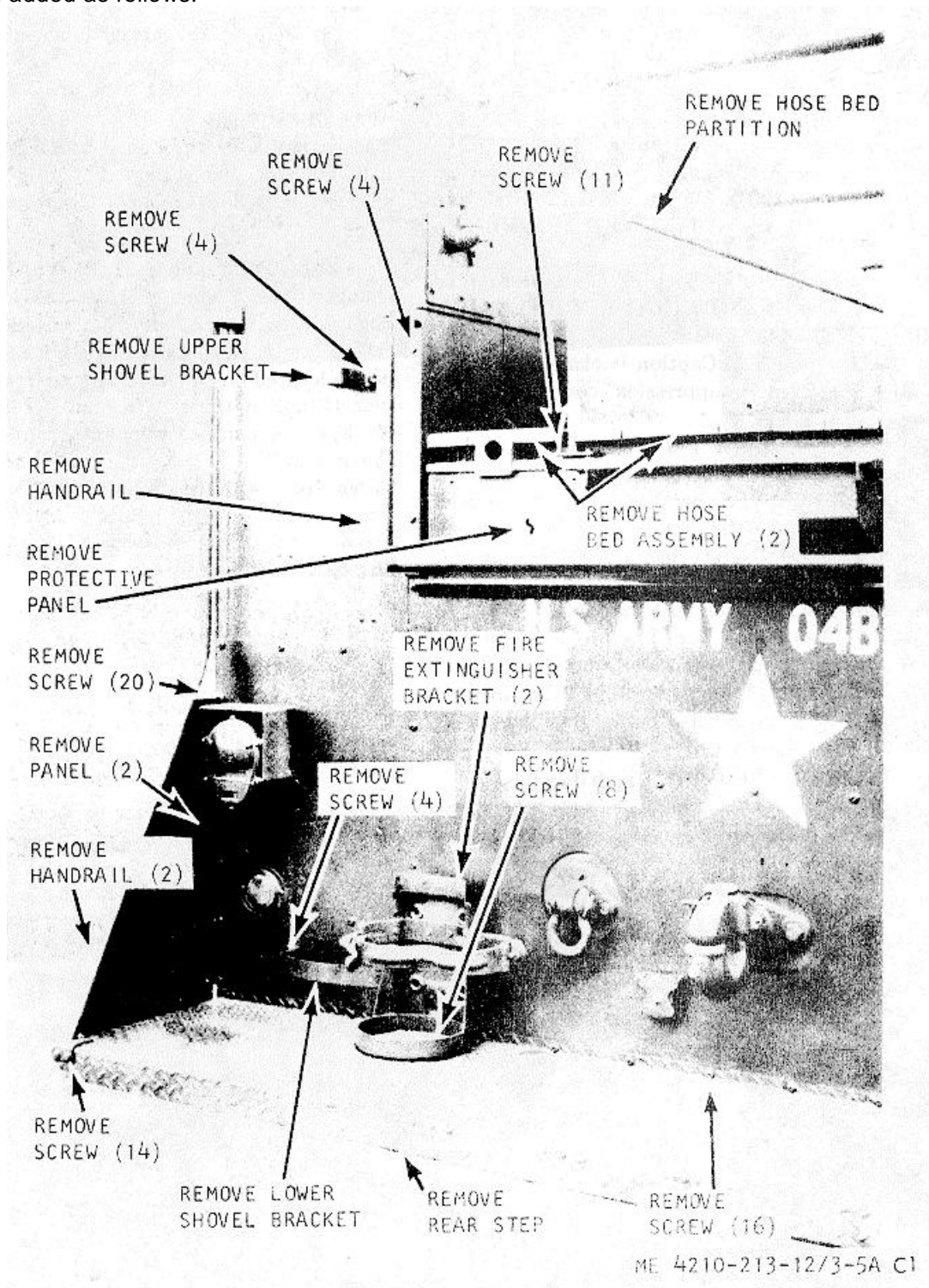

Figure 3-5A. Hose bed assemblies, handrails, rear step, protective panel, and brackets, removal and installation for model FT-500.

Page 3-17. Figure 3-6 caption is changed to read "Ladder support assemblies, retainers, and fill door, removal and installation for model M45A2WLF."

Figure 3-6A is added as follows:

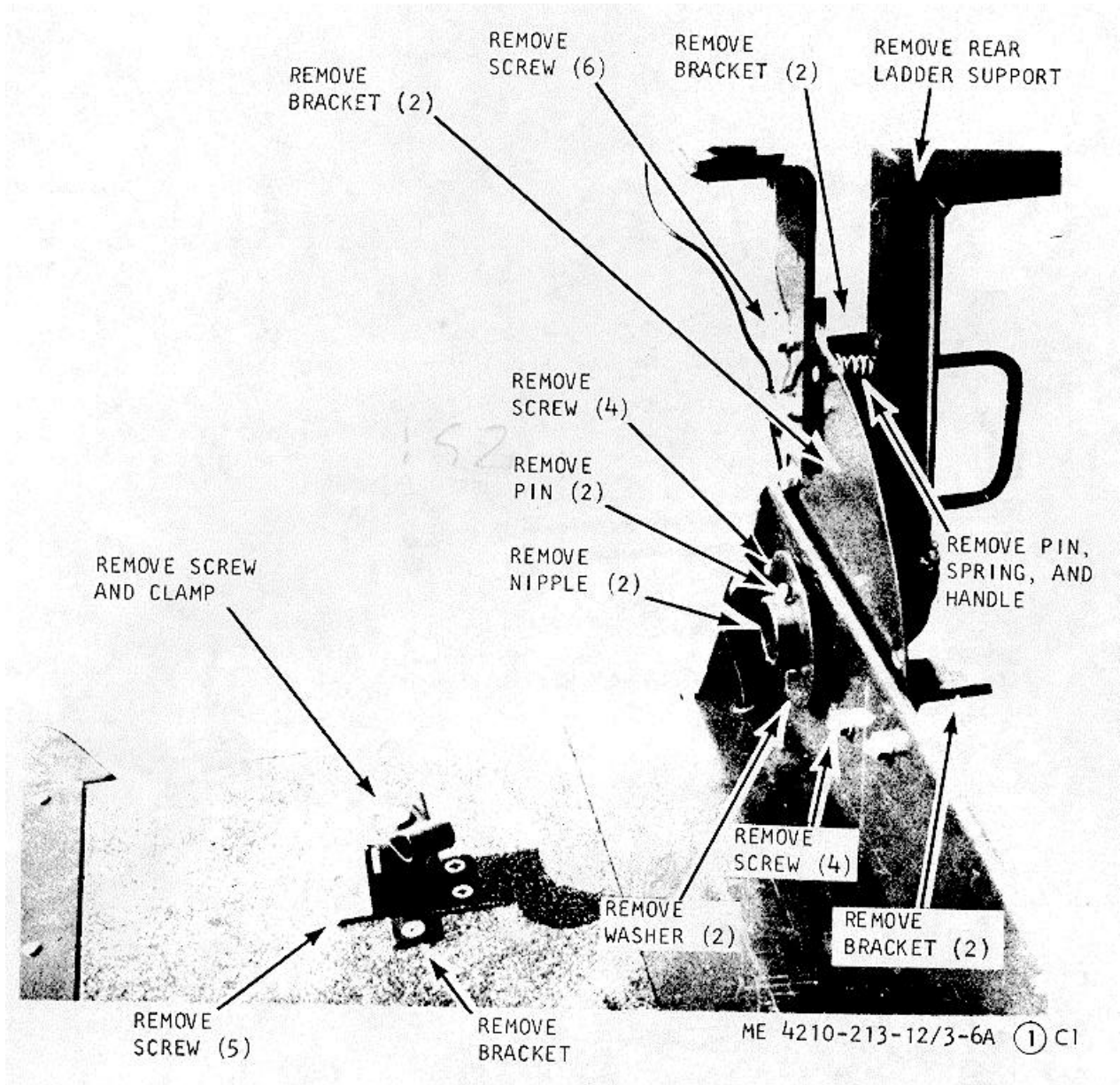

Figure 3-6A. Ladder support assemblies, retainers, and fill door removal and installation for model FT-500 (sheet 1 of 2).

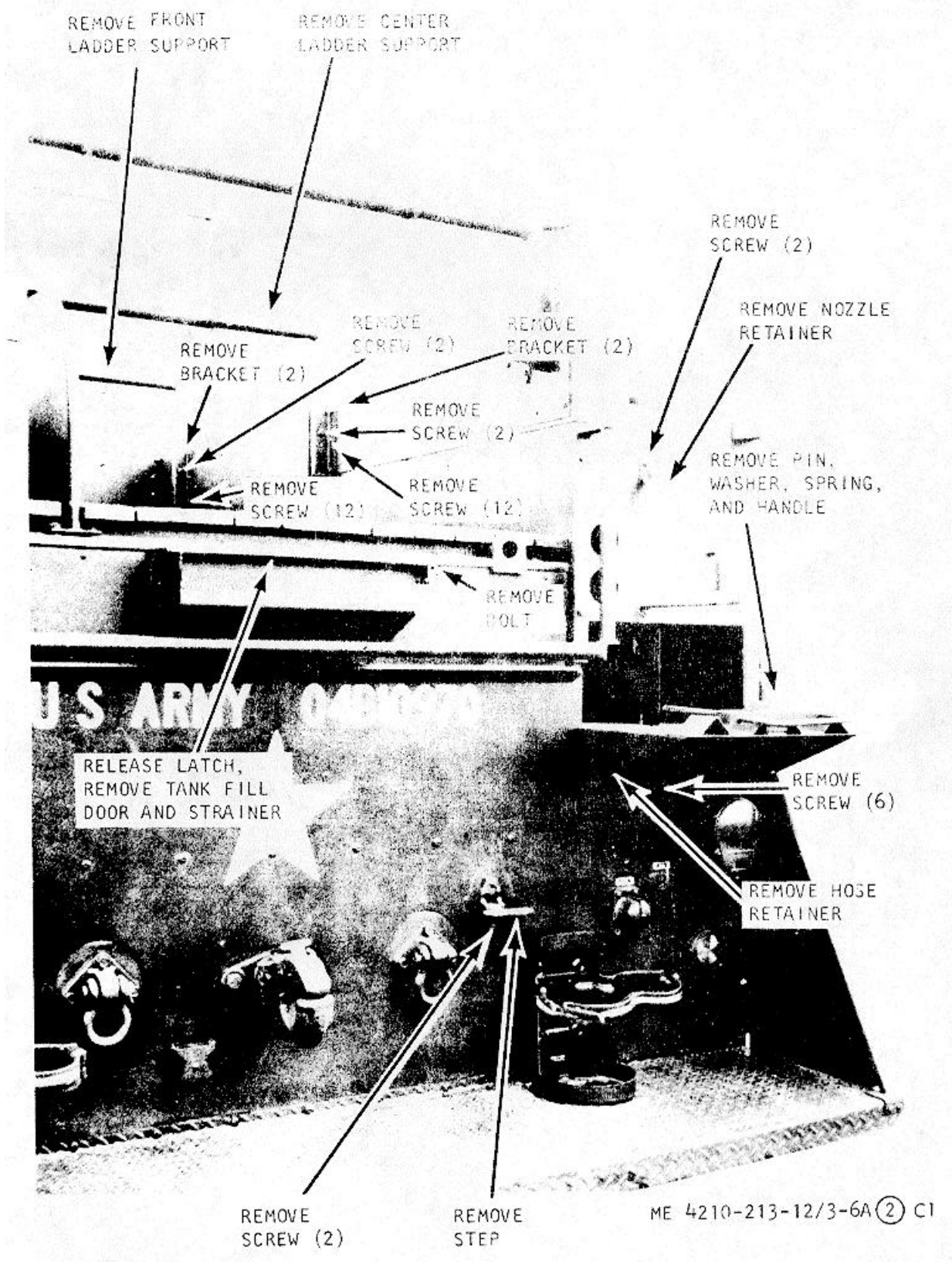

Figure 3-6A. Ladder support assemblies, retainers, and fill door removal and installation for model FT-500 (sheet 2 of 2)

Figure 3-6B is added as follows:

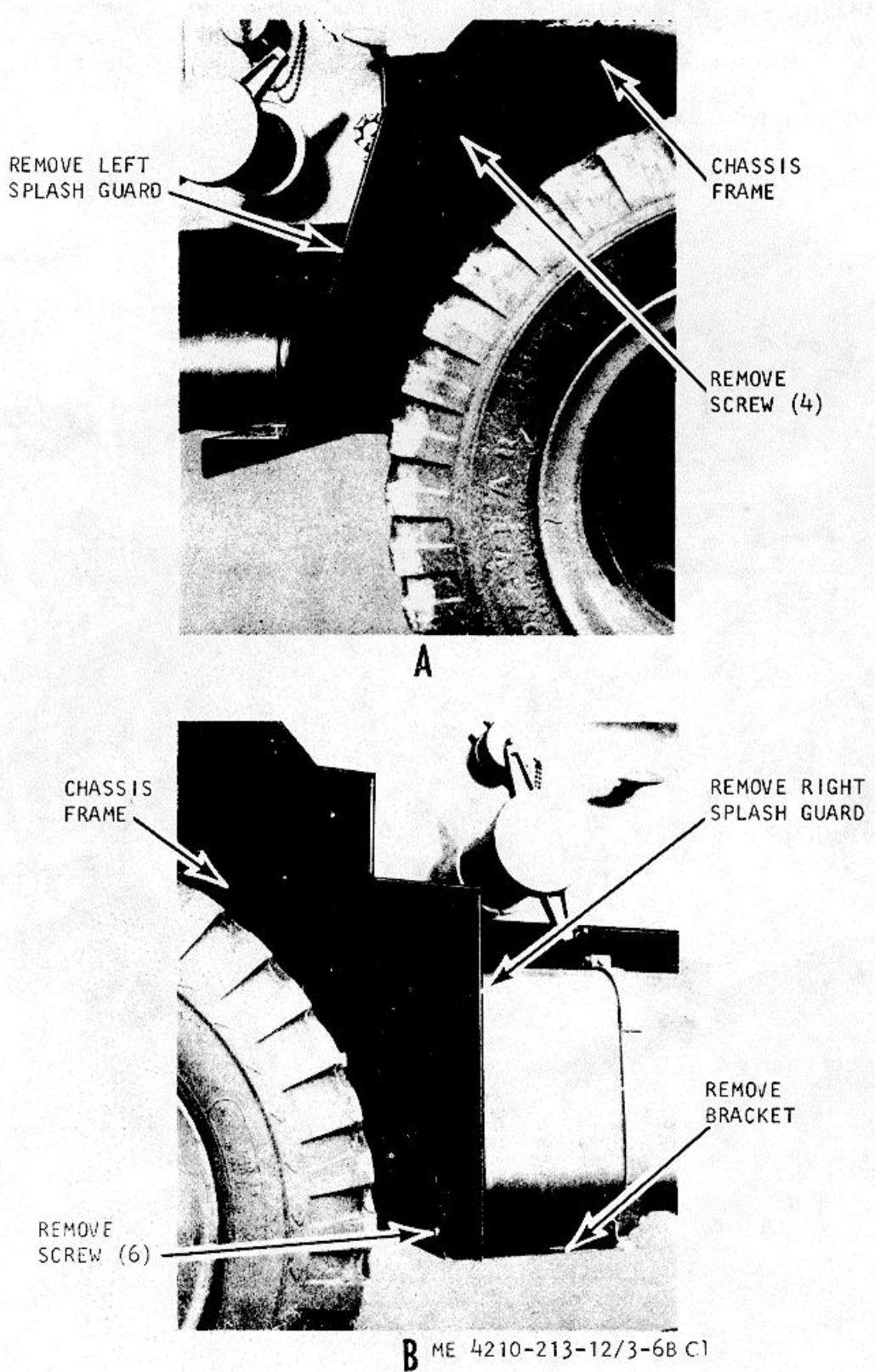

Figure 3-6B. Splash guards, removal and installation for model FT-500.

Page 3-19. Figure 3-7 caption is changed to read "Splash guards, removal and installation for model M45A2WLF."

Page 3-20, figure 3-10. Add note as follows:

NOTE
ON THE MODEL FT-500 FIRE TRUCK, THE NOZZLE ADAPTERS ARE INSTALLED USING RIVETS.

Page 3-22. Figure 3-12 caption is changed to read "Oil pan heater adapter, removal and installation for model M45A2WLF."

Figure 3-12A is added as follows:

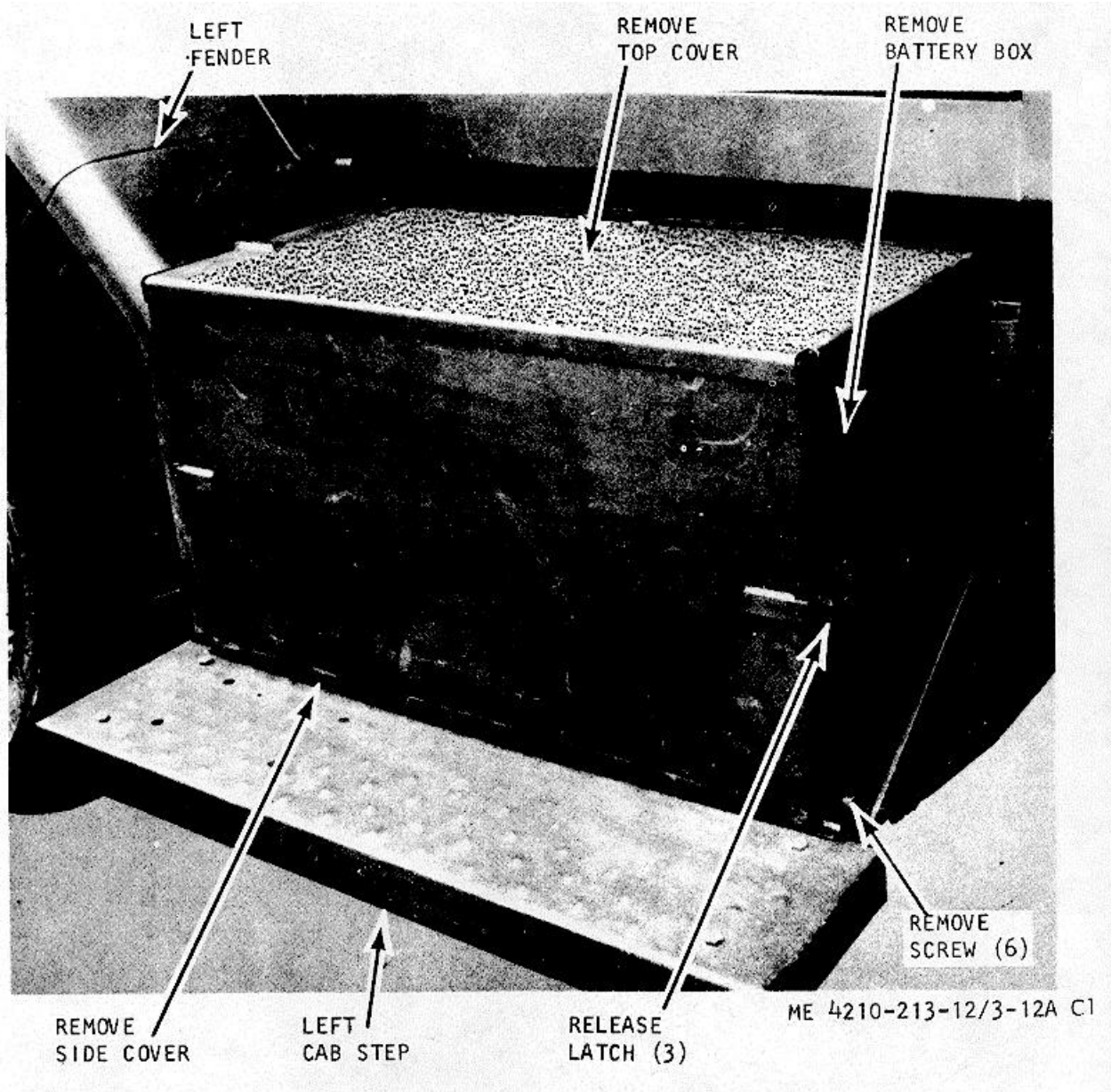
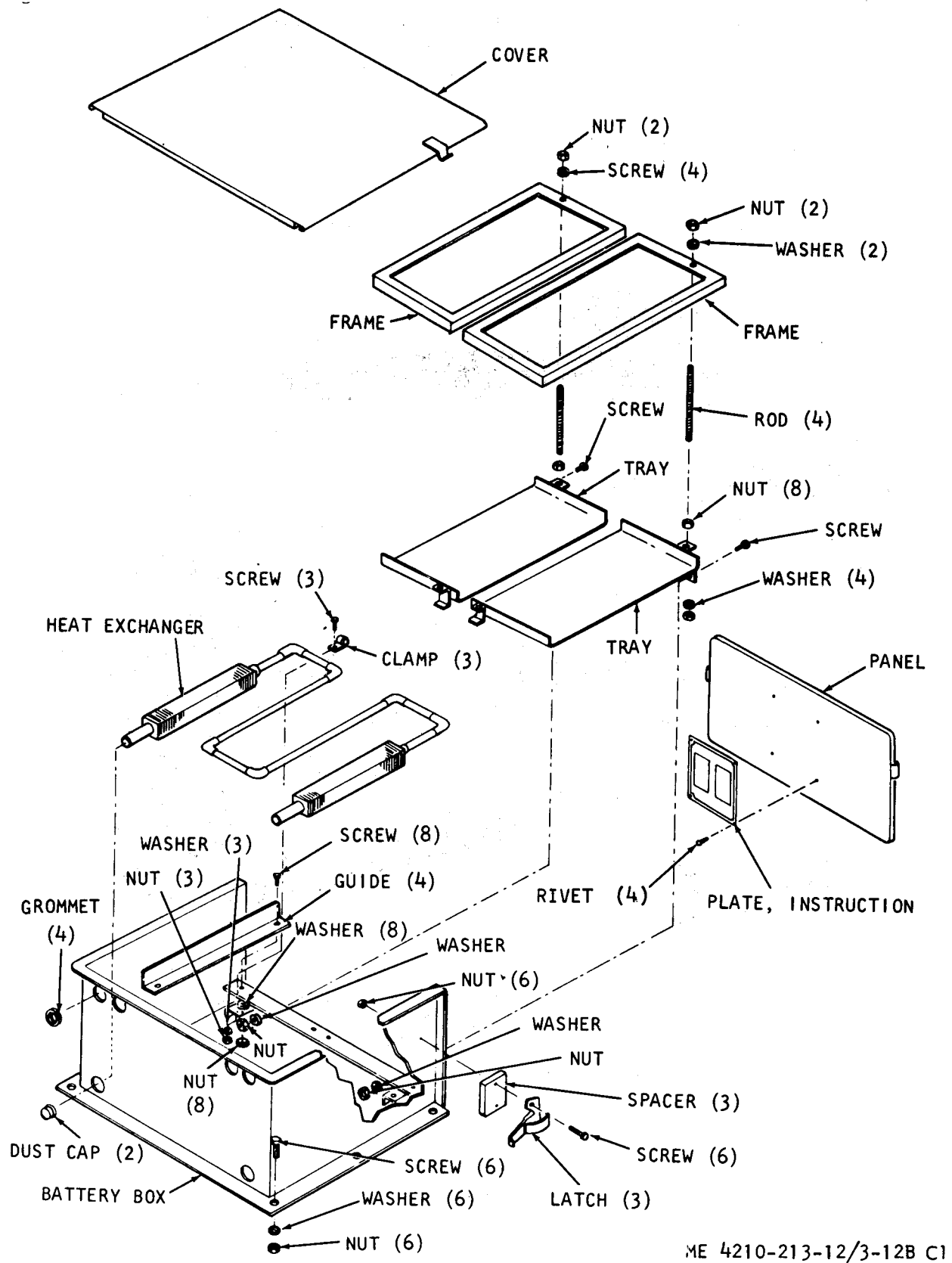

Figure 3-12A. Battery box, removal and installation for model FT-500.

Figure 3-12B is added as follows:



ME 4210-213-12/3-12B C1

Figure 3-12B. Battery box, exploded view for model FT-500.

Page 3-23. Figure 3-13 caption is changed to read "Battery box, removal and installation for model M45A2 WLF."

Page 3-24. Figure 3-14 caption is changed to read "Battery box, exploded view for model M45A2 WLF."

Page 3-25. Figure 3-14A caption is changed to read "Battery and battery cables for model M45A2WLF."

Page 3-26. Figure 3-15A is added as follows:

NOTE
RELIEVE AIR PRESSURE BEFORE REMOVING TUBING.

DISCONNECT OPPOSITE END AT AIR BRAKE CYLINDER AND EMERGENCY BRAKEBAND AND REMOVE TUBING.

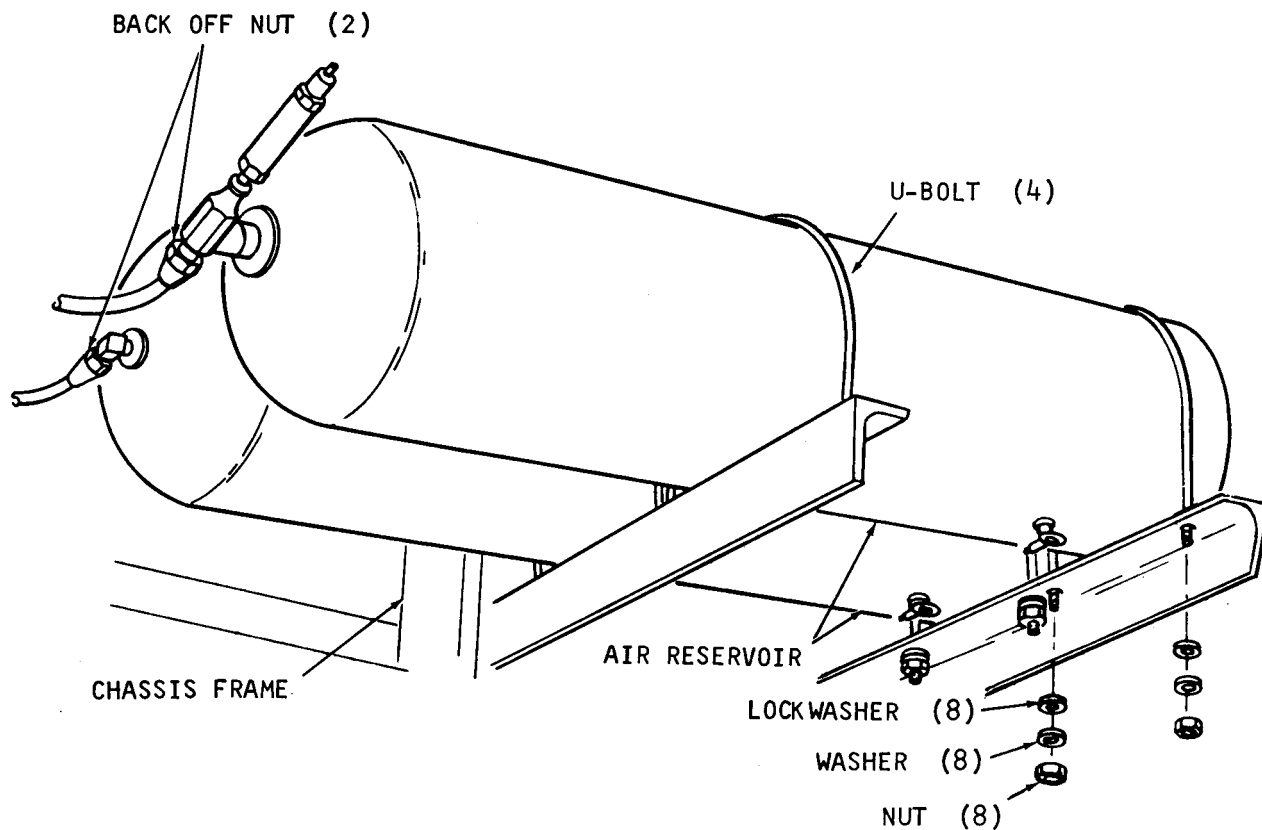

ME 4210-213-12/3-15A C1

Figure 3-15A. Air tank tubing and fittings, removal and installation for model FT-500.

Page 3-27. Figure 3-16 caption is changed to read "Air tank tubing and fittings, removal and installation for model M45A2 WLF."

Paragraph 3-48, lines 24 through 26. Change to read as follows:

"tacles located at the rear of the vehicle. Two 12 volt batteries and their cable assemblies supply power to the model M45A2WLF fire truck. Four 12 volt batteries and their cable assemblies supply power to the model FT-500 fire truck. The temperature and * * *."

Paragraph 3-49. Change "(fig. 1-3)" to read "(fig. 1-3 or 1-4)."

Page 3-28, paragraph 3-54. Change "figure 3-23" to read "figures 3-23 or 3-23A".

Paragraphs 3-58 and 3-59. Change "figure 3-27" to read "figures 3-26A or 3-27".

Pages 3-28 and 3-29 paragraphs 3-6a, c, 3-62a and c. Change "figure 3-29" to read "figure 3-28A or 3-29".

Page 3-29, paragraphs 3-6a, c, 3-64, 3-65, 3-66 and 3-67. Change "figure 3-30" to read "figures 3-30 or 3-30A".

Paragraphs 3-68 and 3-69. Change "figure 3-31" to read "figures 3-30B or 3-31".

Page 3-35. Figure 3-23 caption is changed to read "Siren solenoid relay, removal and installation for model M45A2WLF."

Figure 3-23A is added as follows:

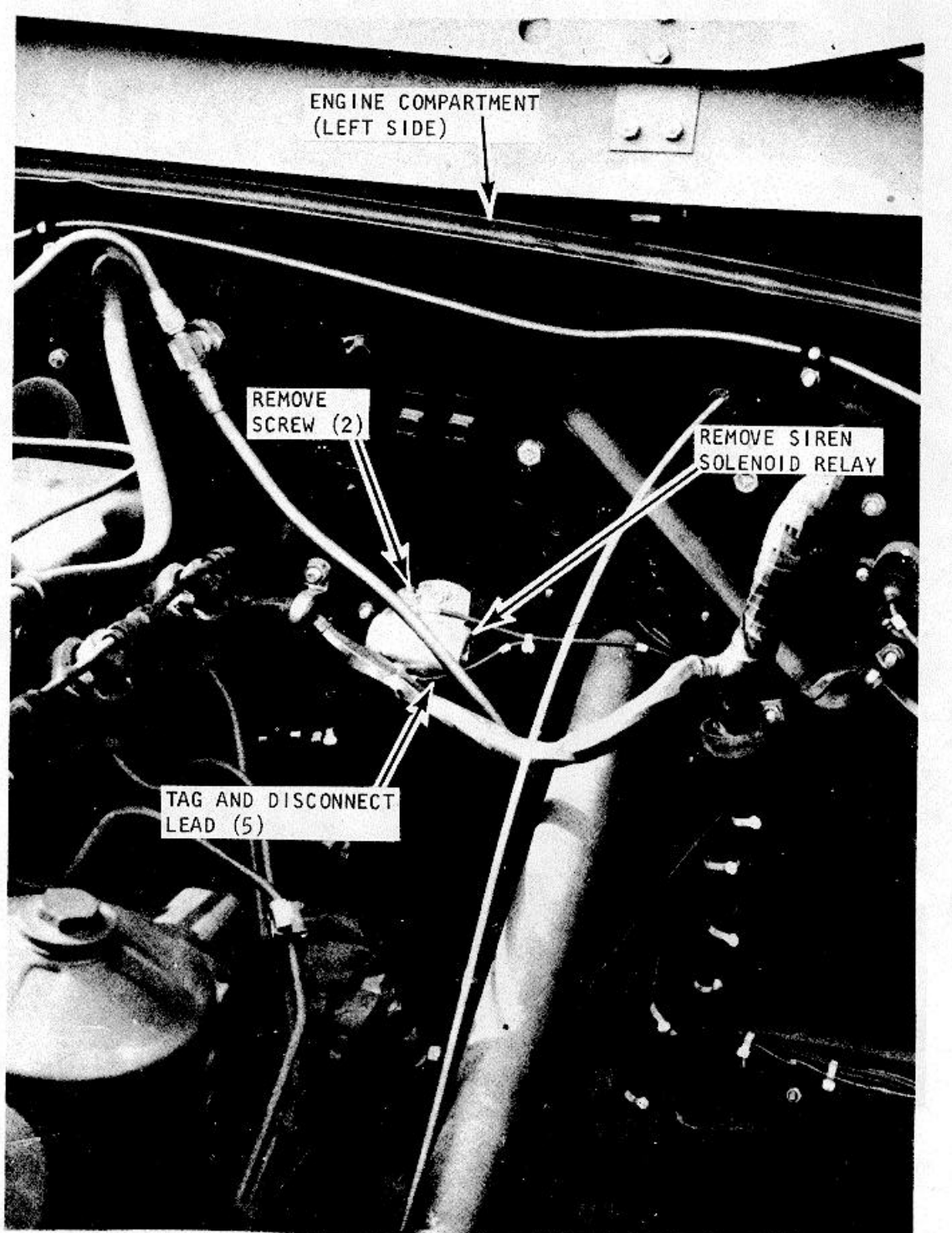

ME 4210-213-12/3-23A C1

Figure 3-23A. Siren solenoid relay, removal and installation for model FT-500.

Page 3-38 Figure 3-26A is added as follows:

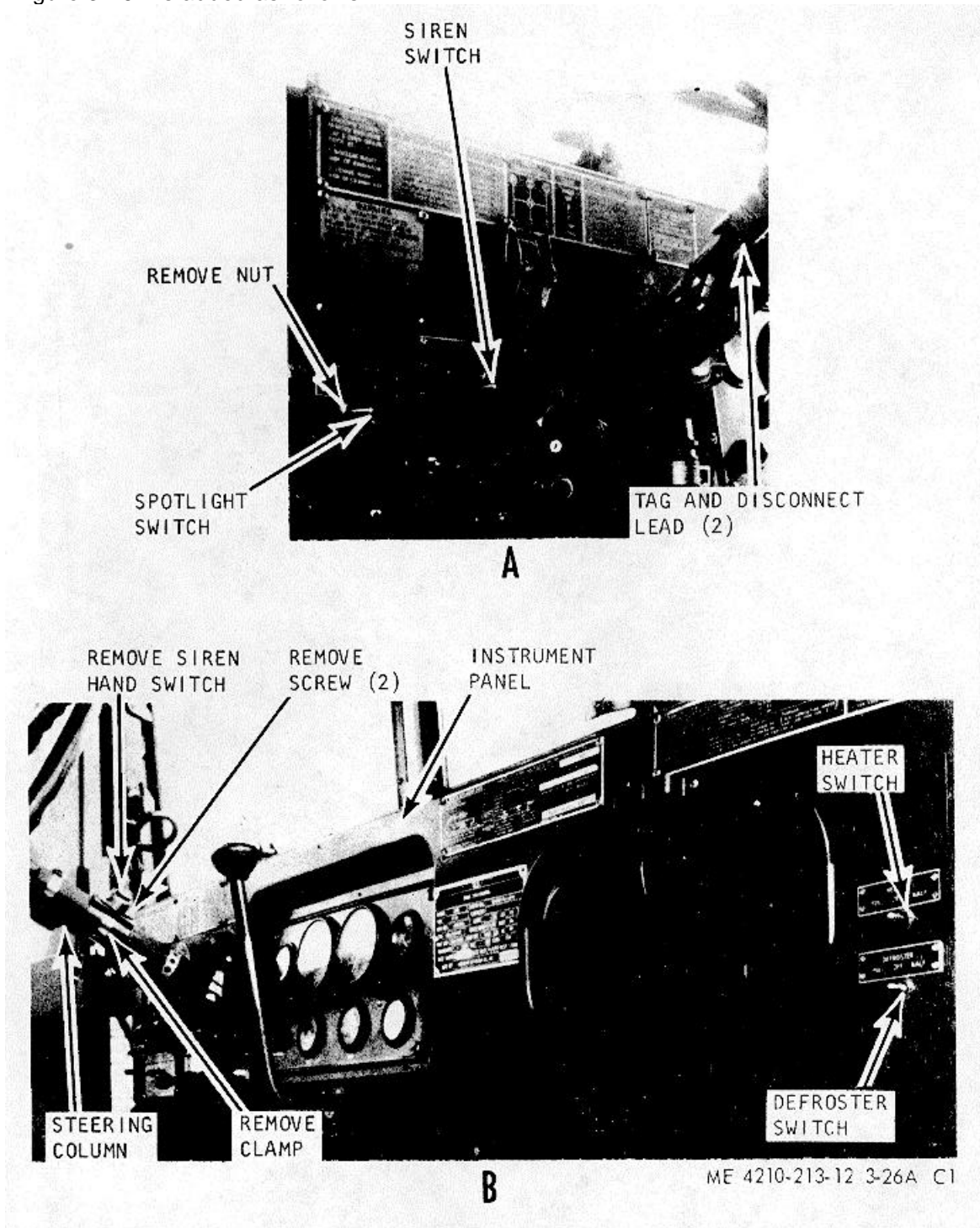

- (1) TAG AND DISCONNECT LEAD AND REMOVE SIREN LIGHT SWITCH
- (2) REMOVE HEATER SWITCH AND DEFROSTER SWITCH IN A SIMILAR MANNER

Figure 3-26A. Warning light itch and siren light switch, removal and installation for model FT-500.

Page 3-39. Figure 3-27 caption is changed to read "Warning light switch and siren light switch, removal and installation for model M45A2 WLF."

Page 3-40, paragraph 3-76a. Change "figure 3-14A" to read "figure 3-14A or 3-33B".
Figure 3-28A is added as follows:

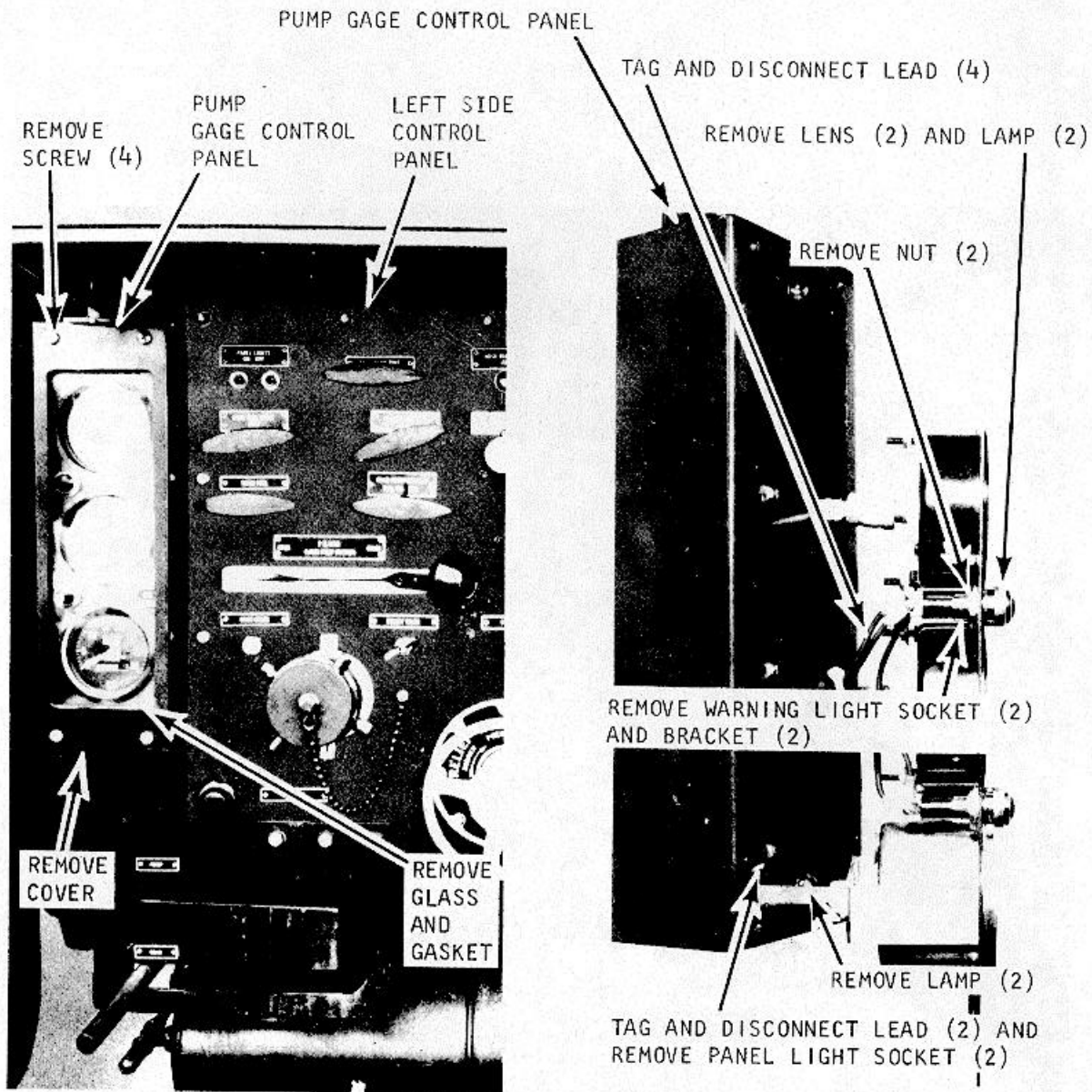

ME 4210-213-12/3 -28A C1

Figure 3-28A. Warning lights and panel lights, removal and installation for model FT-500.

Page 3-41. Figure 3-29 caption is changed to read "Warning lights and panel lights, removal and installation for model M45A2 WLF."

Page 3-42. Figure 3-30 caption is changed to read "Dome light, and electrical control switches, removal and installation for model M45A2 WLF. "

Figure 3-30A is added as follows:

**NOTE
TAG AND DISCONNECT LEADS.**

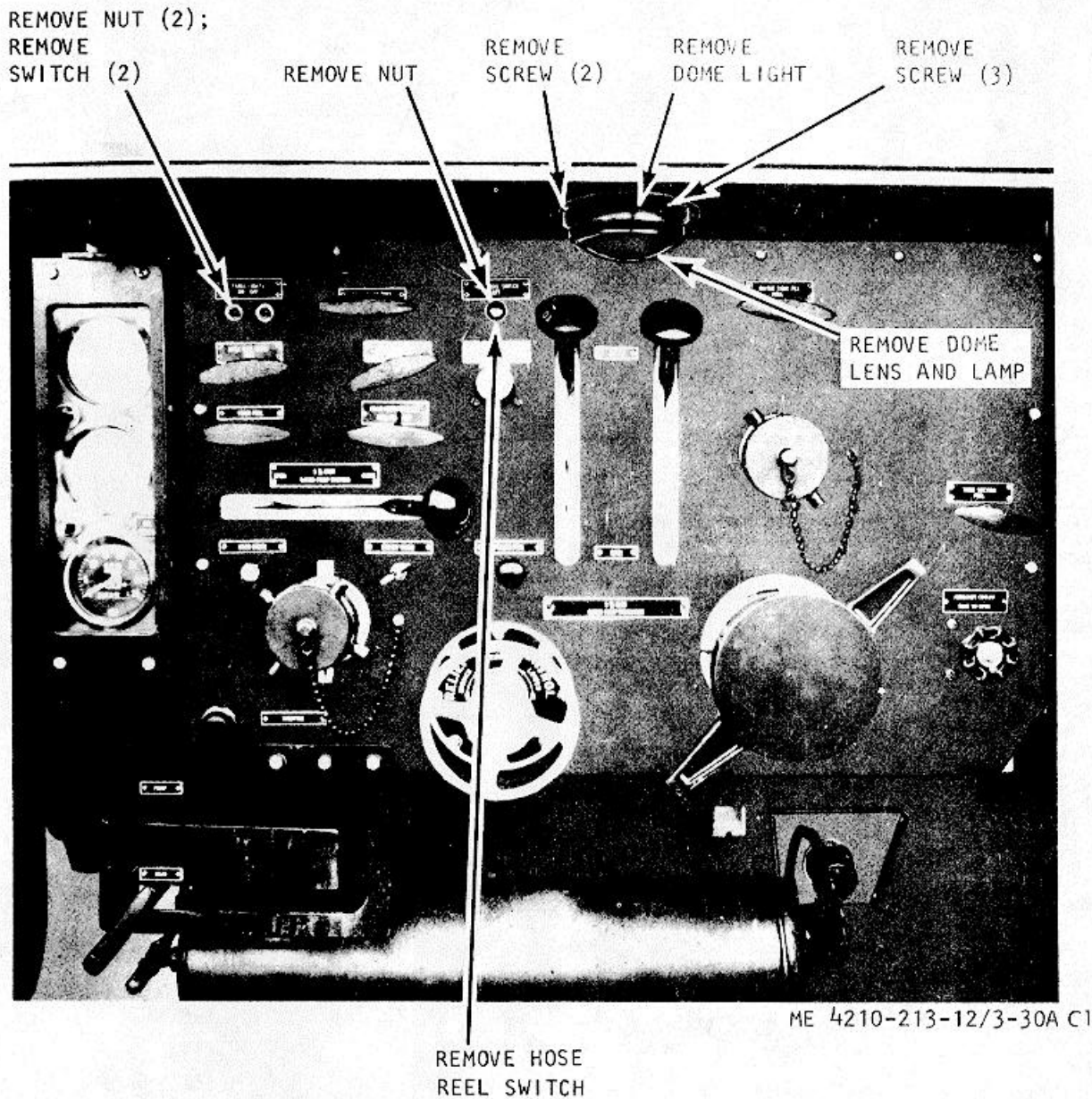

NOTE: REMOVE HOSE REEL SWITCH FROM RIGHT SIDE CONTROL PANEL IN A SIMILAR MANNER.

NOTE: REMOVE DOME LIGHT SWITCH AND HOSE REEL SWITCHES IN A SIMILAR MANNER.

Figure 3-30A. Dome light, and electrical control switches, removal and installation for model FT 500

Figure 3-30B is added as follows:

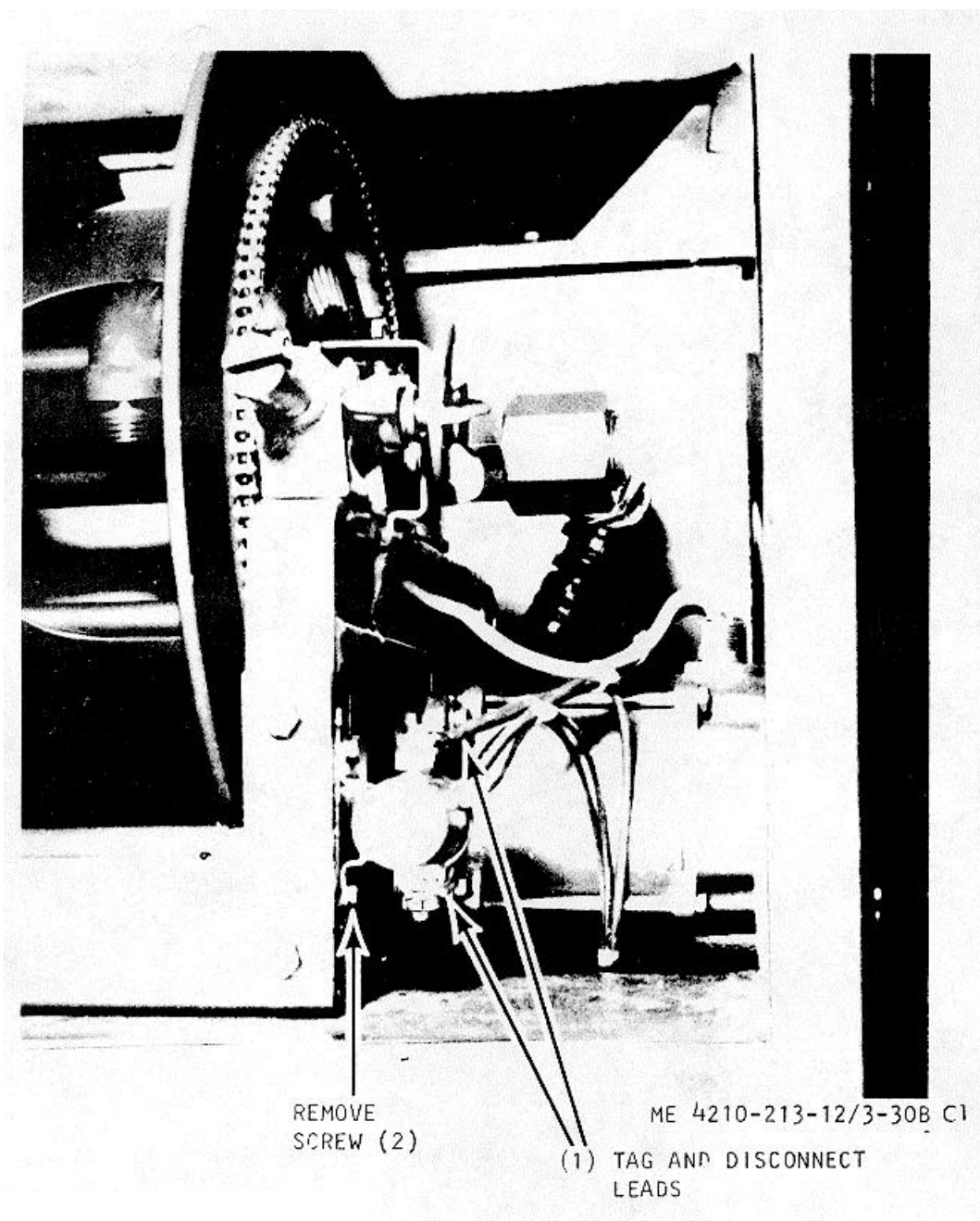

(2) REFER TO FIG. 3-42 AND REMOVE HOSE REEL.

(3) REMOVE HOSE REEL MOTOR.

CHAIN ADJUSTMENT:

MOVE MOTOR BACK TO TIGHTEN
MOVE MOTOR FORWARD TO LOOSEN

Figure 3-30B. Hose reel motor, removal and installation for model FT-500.

Page 3-43. Figure 3-31 caption is changed as follows:
"Hose reel motor, removal and installation for model
M45A2WLF."

Page 3-46. Figure 3-33B is added as follows:

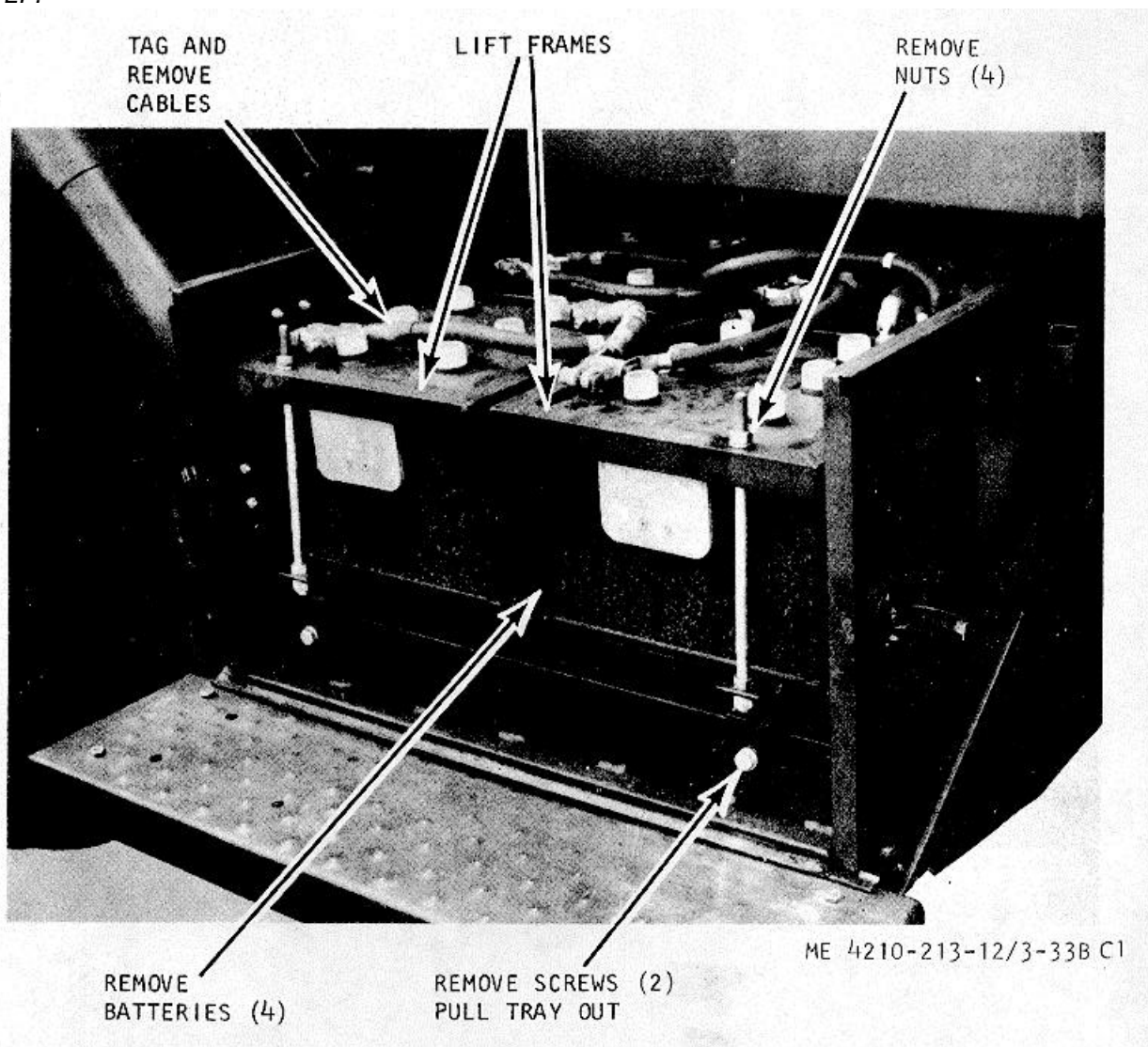

Page 3-48, paragraphs 3-78a(2) and c(1). Change "figure 3-35" to read "figures 3-34A or 3-35".

Paragraphs 3-79a(4) and c(1). Change "figure 3-36" to read "figures 3-35A or 3-36".

Paragraph 3-81a(2). Change "figure 3-27" to read "figure 3-37".

Pages 3-48 and 3-49, paragraphs 3-80a(1) and c(2), 3-81a(1) and c(2). Change "figure 3-29" to read "figures 3-28A or 3-29".

Figure 3-34A is added as follows:

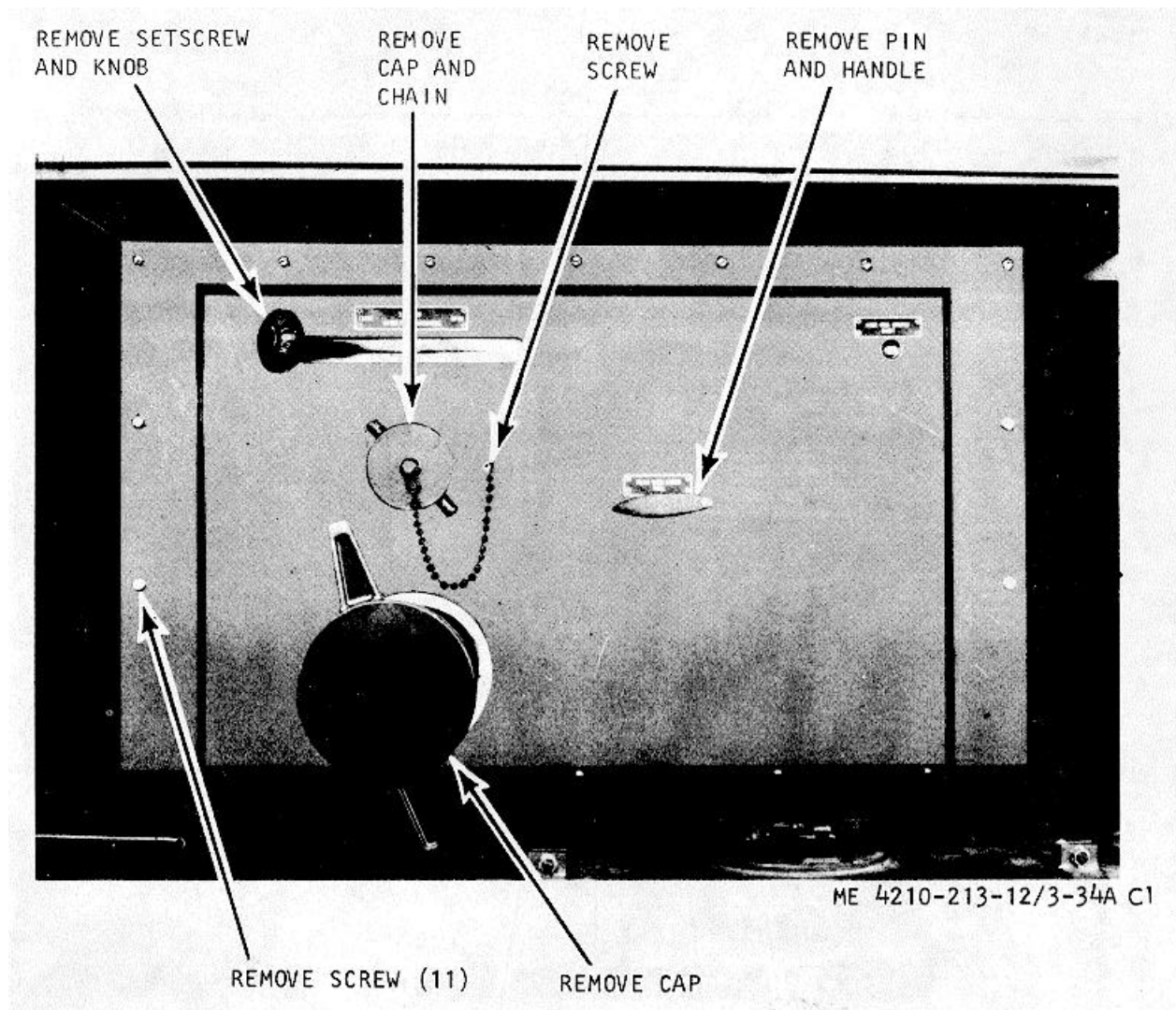
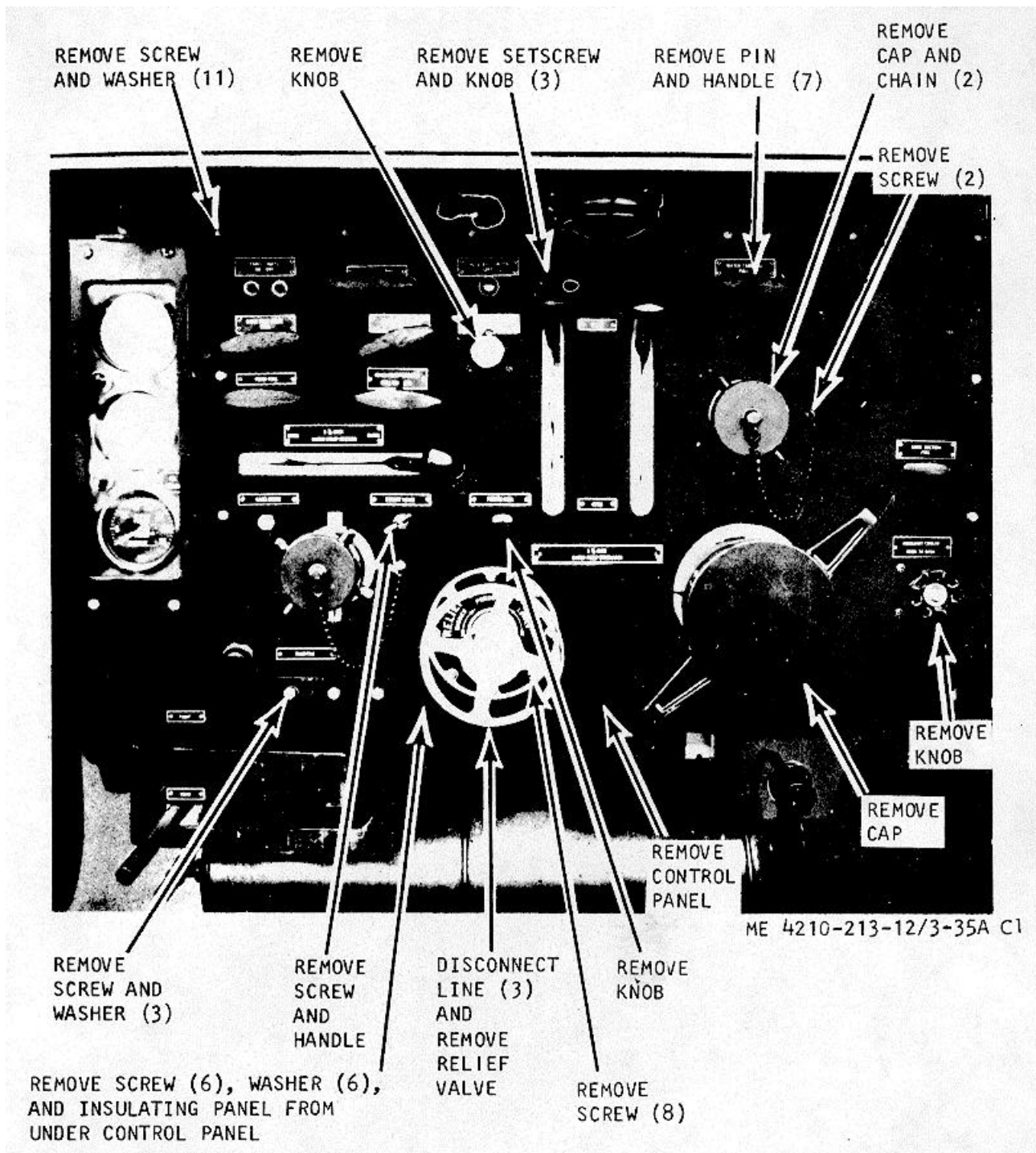

Figure 3-34A. Right side control panel, removal and installation for Model PFT-500.

Page 3-49, paragraphs 3-84a(6) and c(1). Change "figure 3-38" to read "figure 3-38 or 3-38A".

Page 3-50. Figure 9 35 caption is changed to read "Right side control panel. removal and. installation for model M45A2 WLF. "

Figure 3-35A is added as follows:



Page 3-51. Figure 3-36 caption is changed to read "Left side control panel, removal and installation for model M45A2 WLF. " Page 3-52, figure 3-37. Add "(sheet 1 of 3)" to end of caption.

36 Page 3-53, figure 3-37-Continued. Caption is changed as follows: "Figure 3-37. Tachometer, hourmeter pump control panel, removal and installation for model M45A2 'LF (sheet 2 of 3)".

Figure 3-37 (sheet 3 of 3) is added as follows:

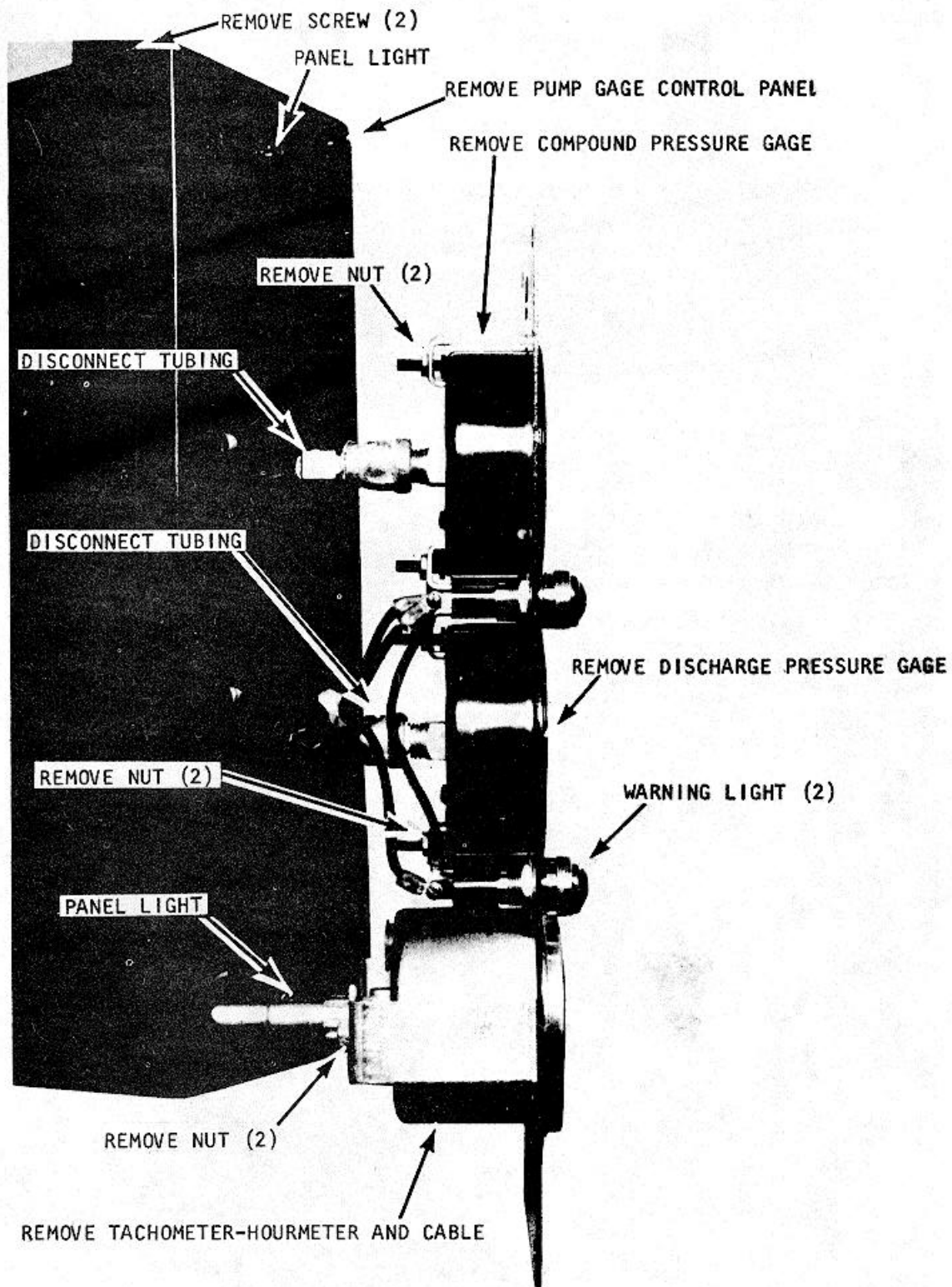

ME 4210-213-12/3-37 ③ C1

C(FT-500)

Figure 3-37. Tachometer, hourmeter pump control panel, removal and installation for model FT-500 (sheet 3 of 3).

Page 3-54. Figure 3-38 caption is changed to read "Apron, removal and installation for model M45A2WLF."

Figure 3-38A is added as follows:

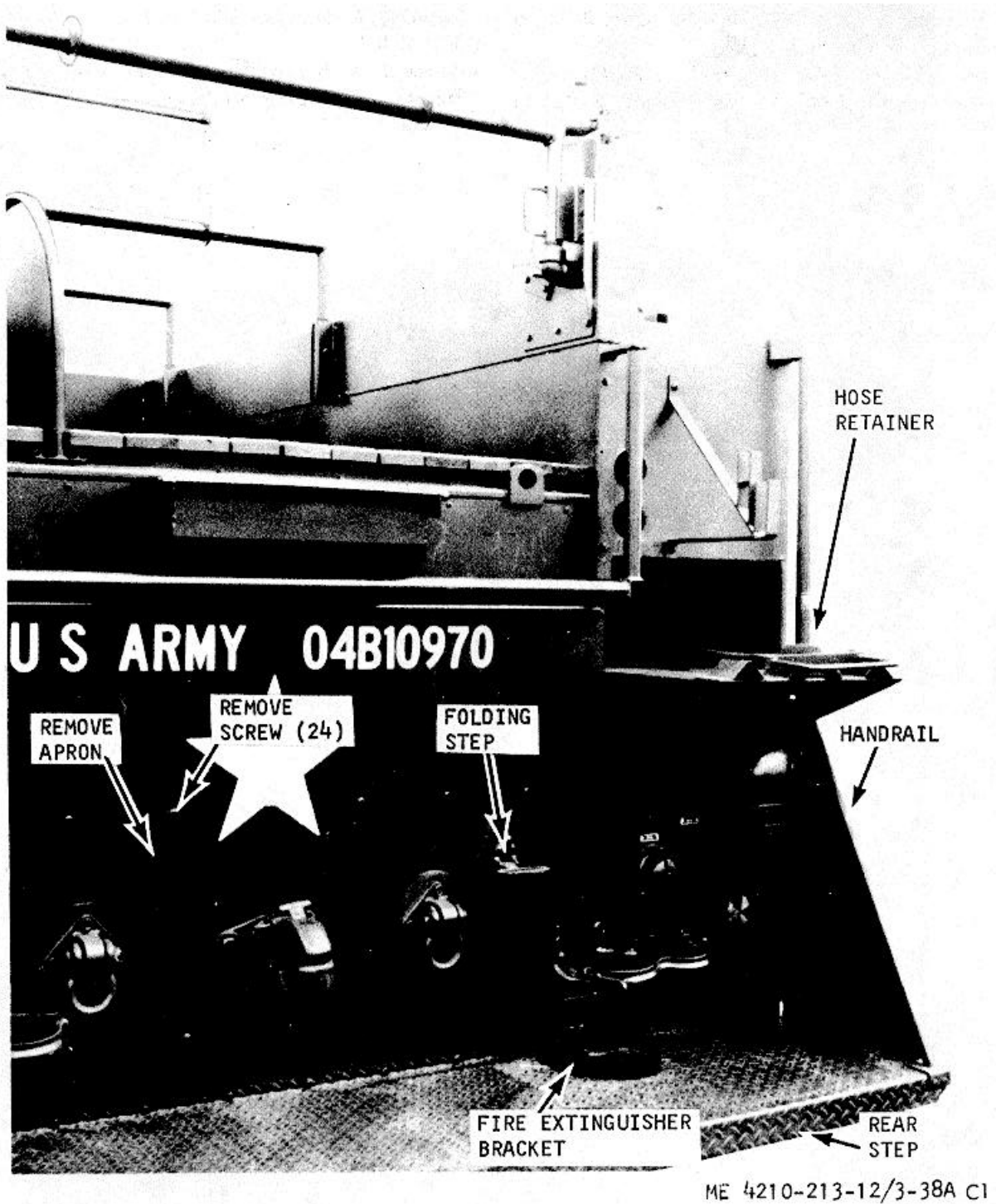
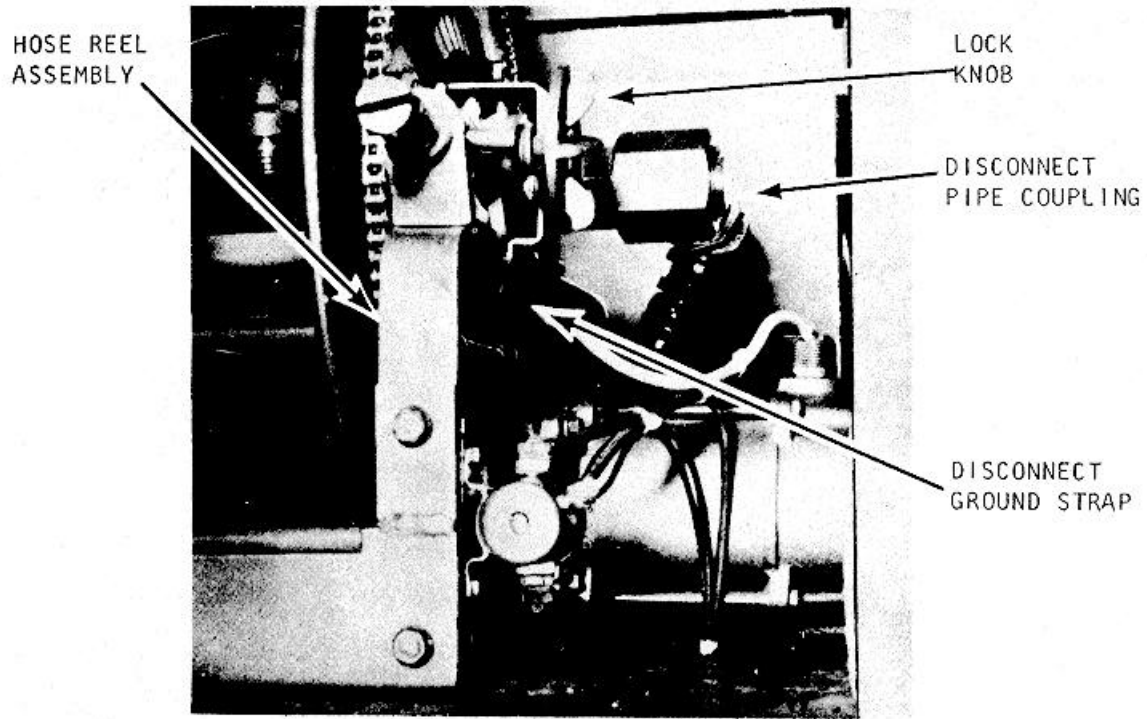

Figure 3-38A. Apron, removal and installation for model FT-500.

Pages 355 and 3-56, paragraphs 3-88a(3) and b(l).
Change "figure 3-41" to read "figures 3-41 or 3-42".
Paragraphs 3-89 and c. Change "figure 3-31" to read
"figures 3-30B or 3-31".
Paragraphs 3-90 and d; Change "figure 3-44" to read
"figures 3-44 or 3-44A".
Pages 3-56 and 3-57, paragraphs 3-92(2) and c.
Change "figure 3-48" to read "figures 3-47A or 3-48".

Paragraph 3-94. Change "figure 3-49" to read "figures
3-47B or 3-49".
Paragraphs 3-95 and c. Change "figure 3-36" to read
"figures 3-35A or 3-36".
Page 3-58. Figure 3-41 caption is changed to read
**"Hose reel, removal and installation for model M45A2
WLF."**
Delete the statement-"Figure 3-42. Not used".
Figure, 3-42 is added as follows:



A

REMOVE HOSE REEL ASSEMBLY

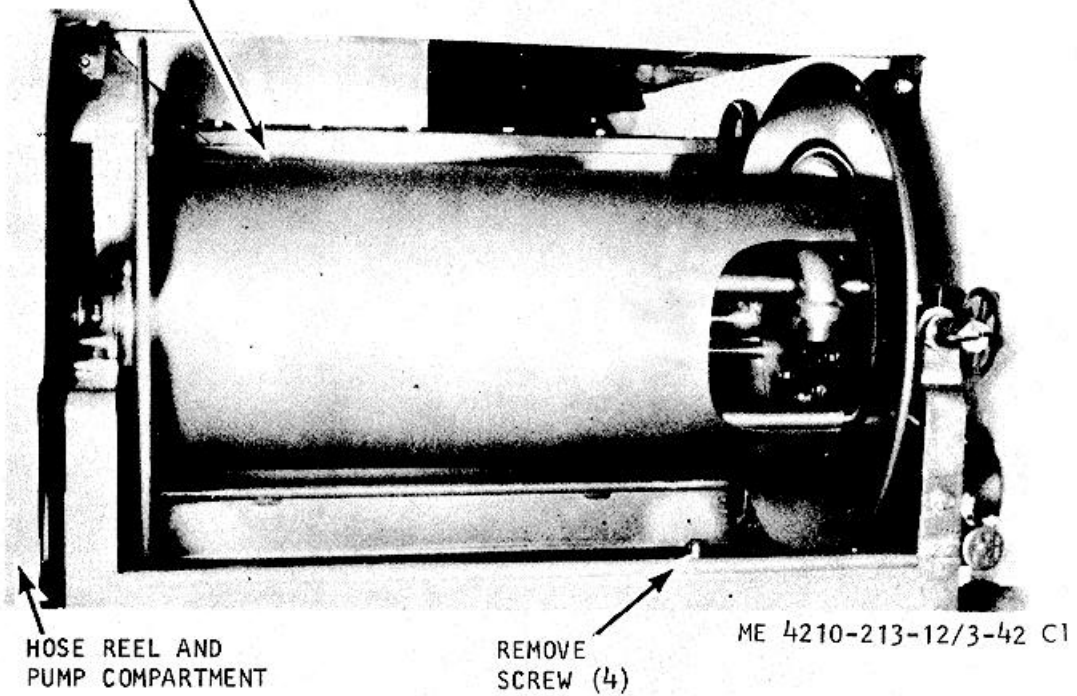

B

Figure 3-42. Hose reel, removal and installation for model FT-500.

Page-5-60. Figure 3-44 caption is changed to read "Pump clutch linkage, for model M45A2WLF, exploded view."

Figure 3-44A is added as follows:

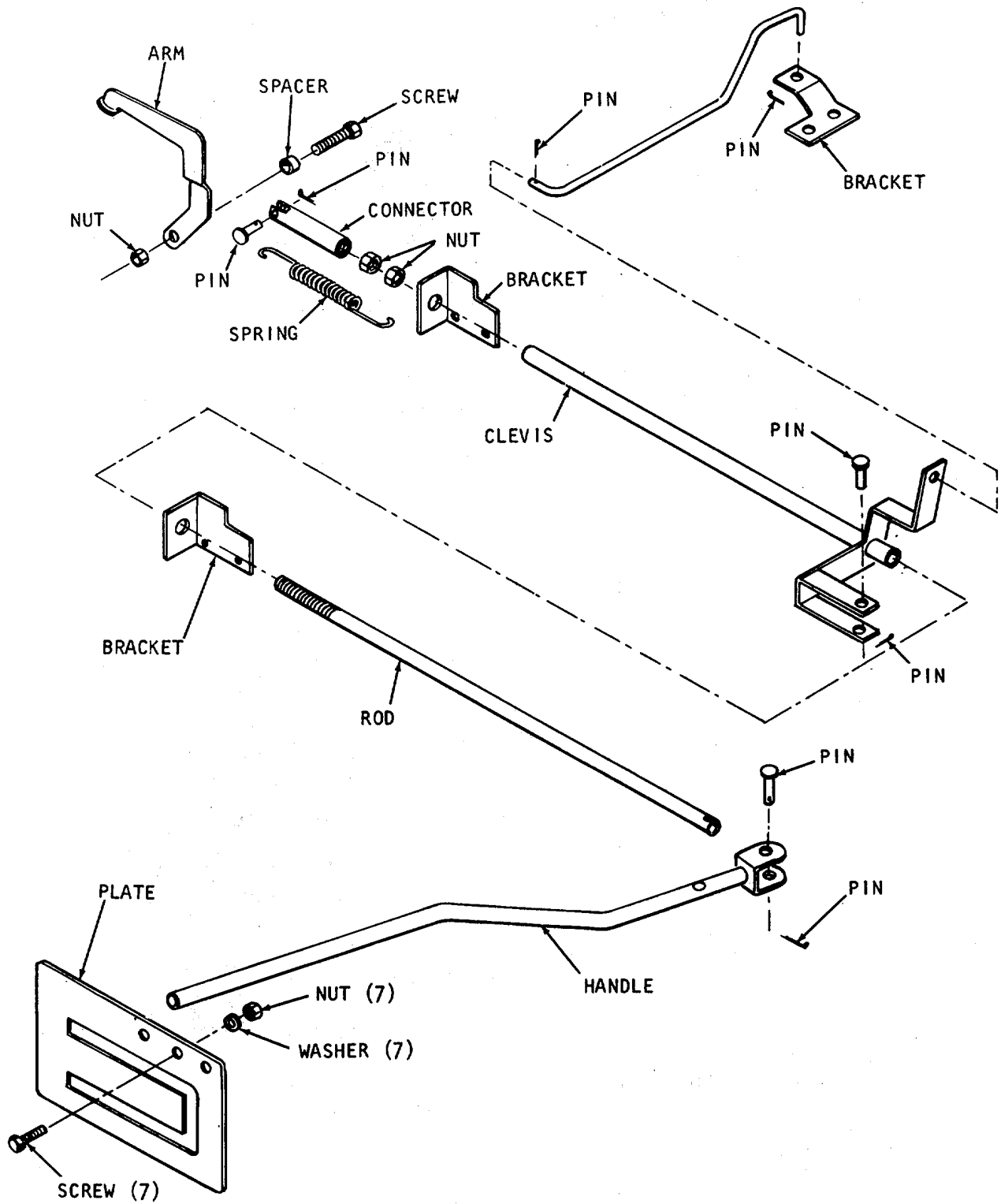

ME 4210-213-12/3-44A C1
Figure 3-44A. Pump clutch linkage, for model FT-500, exploded view.

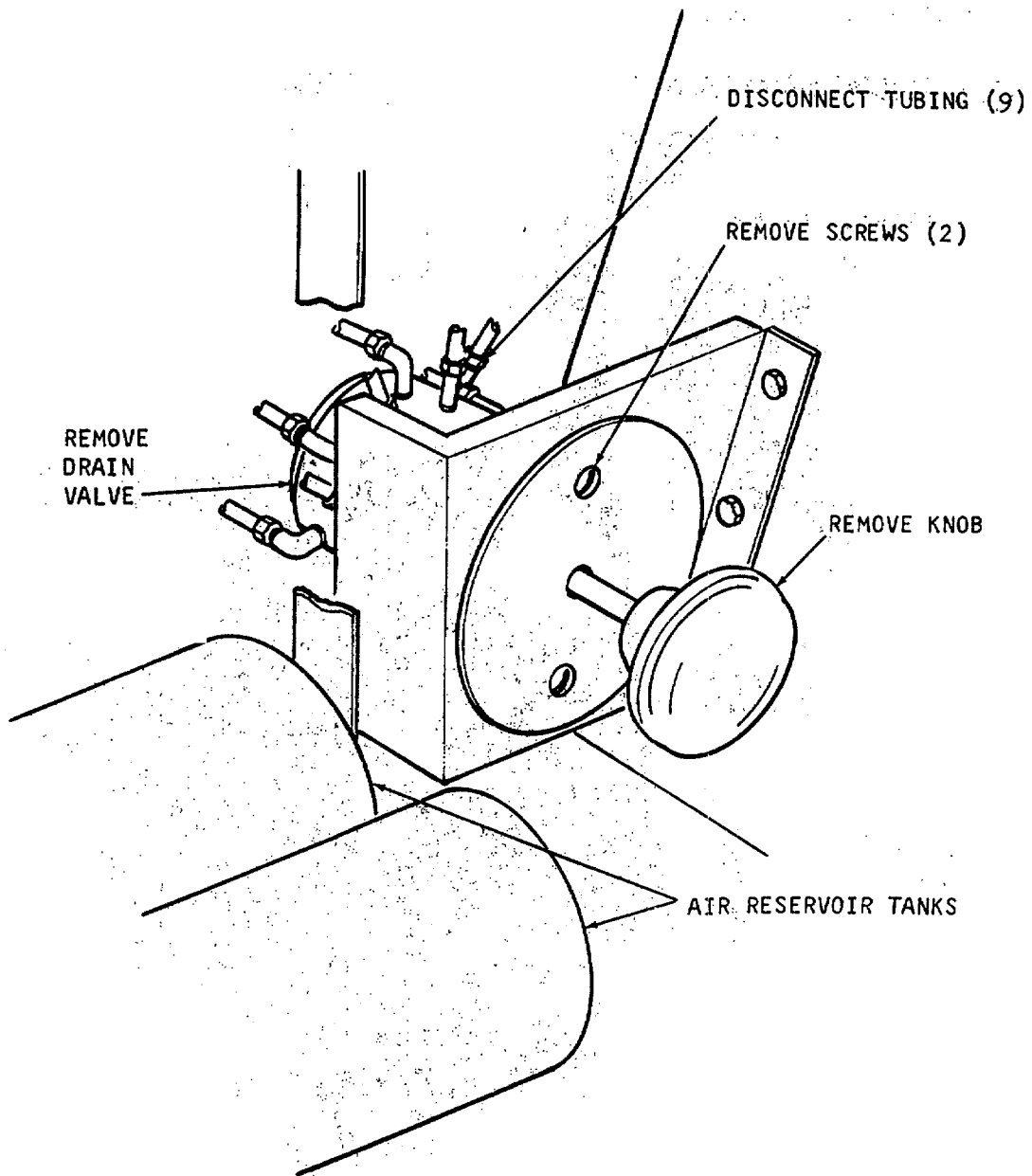
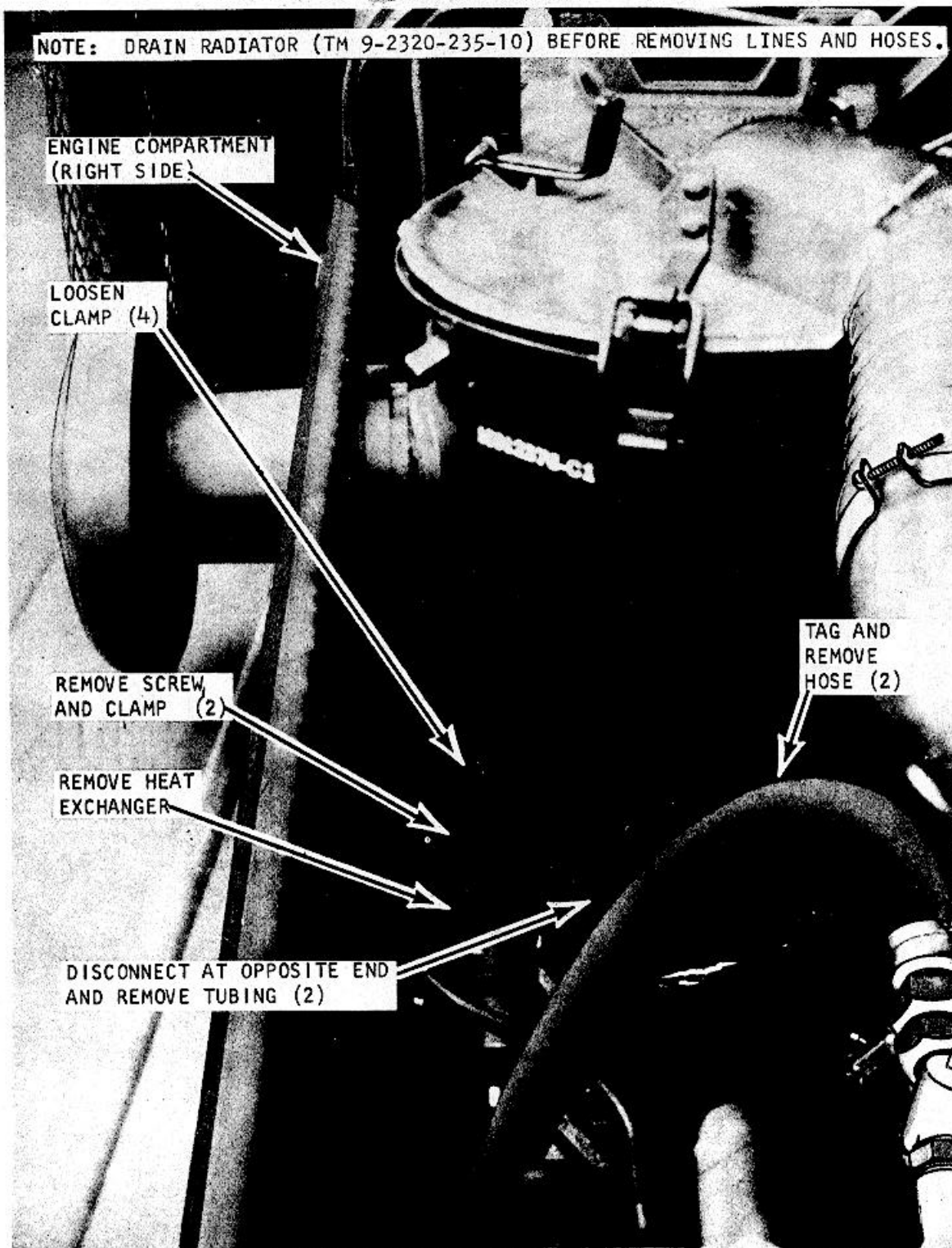

Figure 3-47A. Drain valve and tubing, removal and installation (FT-500).

Figure 3-47A. Drain valve and tubing, removal and installation for model FT-500.

Figure 3-47B is added as follows:



ME 4210-213-12/3-47B C1

Figure 3-47B. Heat exchanger and tubing, removal and installation for Model FT-500.

Page 3-63. Figure 348 caption is changed to read "Drain valve and tubing, removal and installation for model M45A2 WLF."

Figure 3-49 caption is changed to read "Heat exchanger and tubing, removal and installation for model M145A2W LF."

Page 3-65. Figure 3-50A is added as follows:

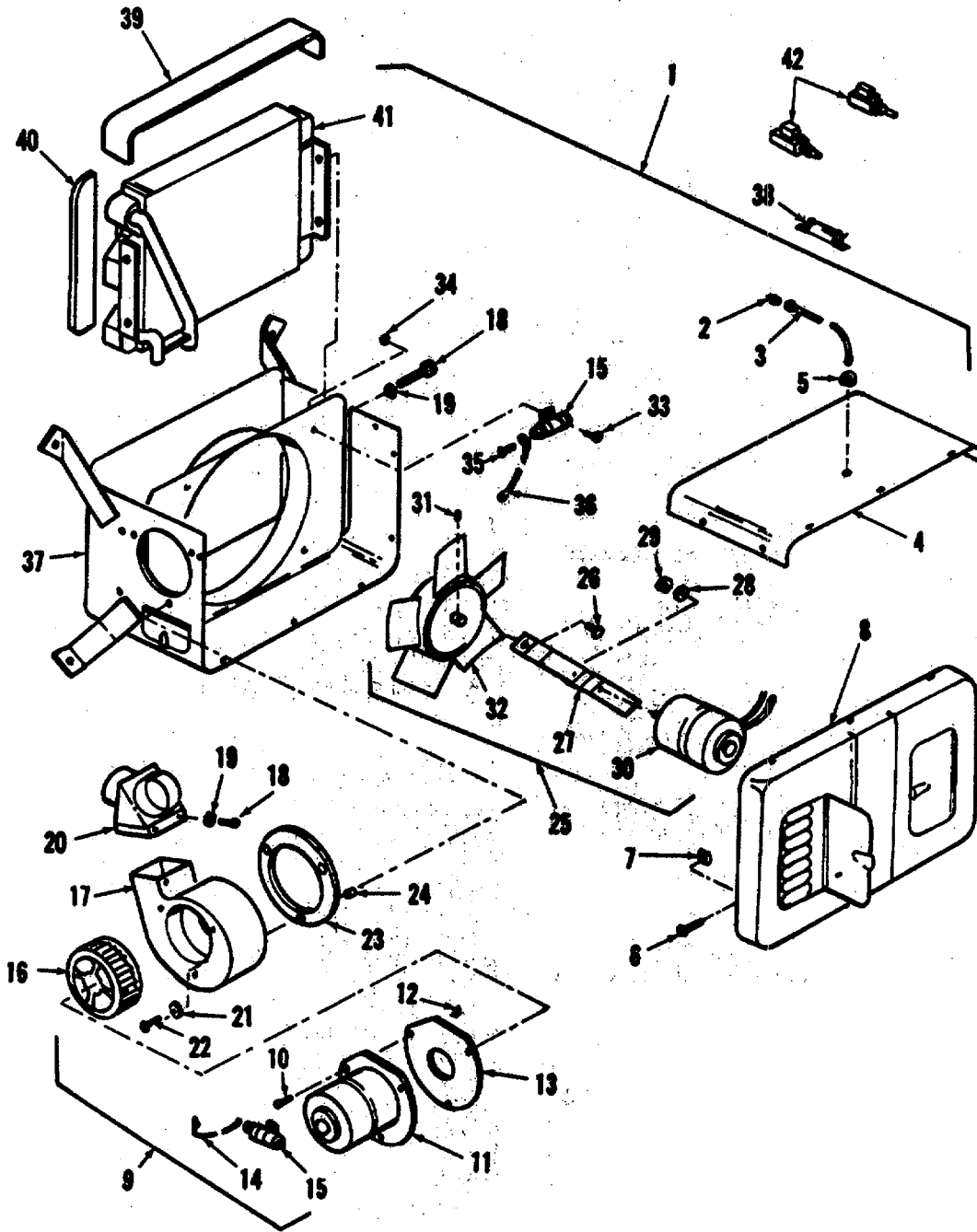

Figure 3-50A. Vehicular compartment heater, for Model FT-500, exploded view.

KEY to Figure 3-50A.

- | | | | |
|----|-----------------------------------|----|----------------------------------|
| 1 | Heater, vehicular-compartment | 22 | Washer, lock |
| 2 | Connector | 23 | Gasket, blower housing |
| 3 | Lead, electrical | 24 | Spacer |
| 4 | Panel, top | 25 | Motor and fan assembly, heater |
| 5 | Grommet | 26 | Screw assembly, |
| 6 | Screw | 27 | Bracket, motor mounting |
| 7 | Nut, stamped | 28 | Washer, flat |
| 8 | Cover assembly, front | 29 | Nut assembly, washer |
| 9 | Motor and wheel assembly, adapter | 30 | Motor, D. C. |
| 10 | Screw, cap, hex head | 31 | Setscrew |
| 11 | Motor, D.C. | 32 | Fan |
| 12 | Nut, stamped | 33 | Screw assembly, washer |
| 13 | Gasket, motor mounting | 34 | Nut assembly, washer |
| 14 | Lead, electrical | 35 | Screw assembly, washer |
| 15 | Suppressor | 36 | Lead, electrical |
| 16 | Wheel, blower | 37 | Housing, heater |
| 17 | Housing, blower | 38 | Resistor |
| 18 | Screw, tapping, thread cutting | 39 | Spacer, core ends top and bottom |
| 19 | Washer, lock | 40 | Spacer, core ends |
| 20 | Defroster Y | 41 | Core, heater |
| 21 | Screw | 42 | Switch, toggle |

Page 3-65, paragraphs 3-98b and d. Change "(fig. 3-51)" to read "figures 3-50A or 3-51."

Page 3-66. Figure 3-51 caption is changed to read **"Vehicular compartment heater for model M45A2 WLF, exploded view"**.

Page 3-67. Figure 3-51 caption is changed to read **"Figure 3-51. Vehicular compartment heater for model M45A2 WLF, exploded view-Continued"**.

Page A-1, paragraph A-3. Add the following:
TM 5-4210-213-25P Organizational, Direct and General Support and Depot Maintenance Repair Parts and Special Tools

List for Truck, Fire Fighting, Power Pumper; Foam and Water, 500 GPM, Centrifugal Pump Power Take-Off Driven, 40 Gal. Foam Chemical Tank (Ward LaFrance Truck Corp. Mdl M45A2WLF) FSN 4210-298-3515.

Paragraph A- is rescinded.

Last page, figure 1-3. Change caption to read **Wiring diagram for model M45A2 WLF**.

By Order of the Secretary of the Army:

Official:

KENNETH G. WICKHAM,
Major General, United States Army,
The Adjutant General.

W. C. WESTMORELAND,
General, United States Army,
Chief of Staff.

Distribution:

To be distributed in accordance with DA Form 12-25, Sec I (qty rqr Block #122), Organizational maintenance requirements for Equipment: Fire Fighting.

TECHNICAL MANUAL }
 No. 5-4210-213-12

HEADQUARTERS
 DEPARTMENT OF THE ARMY
 WASHINGTON, D.C., 10 May 1968

**OPERATOR AND ORGANIZATIONAL MAINTENANCE MANUAL
 TRUCK, FIRE FIGHTING, POWERED PUMPER, FOAM AND WATER
 500 GALLONS PER MINUTE CAPACITY, CENTRIFUGAL PUMP,
 POWER TAKEOFF DRIVEN,
 400 GALLON WATER TANK, 40 GALLON FOAM CHEMICAL
 TANK, CLASS 530B, NONWINTERIZED
 (WARD LAFRANCE MODEL M45A2WLF)
 FSN 4210-9283515**

	Paragraph	Page
CHAPTER 1. INTRODUCTION		
Section I. General.....	1-1, 1-2	1-1
II. Description and tabulated data.....	1-3 - 1-5	1-1 - 1-5
CHAPTER 2. INSTALLATION AND OPERATING INSTRUCTIONS		
Section I. Service upon receipt of equipment.....	2-1 - 2-5	2-1, 2-2
II. Movement to a new worksite.....	2-6, 2-7	2-2
III. Controls and instruments.....	2-8, 2-9	2-2
IV. Operation of equipment.....	2-10 - 2-23	2-2 - 2-4
V. Operation of auxiliary material used in conjunction with fire truck.....	2-24	2-24
CHAPTER 3. OPERATOR AND ORGANIZATIONAL MAINTENANCE INSTRUCTIONS		
Section I. Operator and organizational maintenance tools and equipment.....	3-1, 3-2	3-1
II. Lubrication.....	3-3, 3-4	3-1
III. Preventative maintenance services.....	3-5 - 3-7	3-1, 3-9
IV. Operator's maintenance.....	3-8	3-9
V. Troubleshooting.....	3-9 - 3-19	3-9, 3-10
VI. Radio interference suppression.....	3-20 - 3-24	3-10 - 3-12
VII. Retainers, steps, guards, hose bed assemblies, and ladder support assemblies.....	3-25 - 3-36	3-12, 3-13
VIII. Compartment accessory door, battery box and oil pan heater adapter....	3-37 - 3-43	3-14, 3-15
IX. Fuel system.....	3-44, 3-45	3-16
X. Air system.....	3-46, 3-47	3-15
XI. Electrical system.....	3-48 - 3-76	3-27 - 3-40
XII. Controls, instruments and panels.....	3-77 - 3-85	3-48, 3-49
XIII. Pumping system.....	3-86 - 3-96	3-55 - 3-57
XIV. Vehicular compartment heater.....	3-97, 3-98	3-65
XV. Lubrication system.....	3-99, 3-100	3-65
APPENDIX A. References.....		A-1
B. Basic issue items.....		B-1
C. Maintenance allocation chart.....		C-1
INDEX.....		I-1

CHAPTER 1 INTRODUCTION

Section I. GENERAL

1-1. Scope

a. These instructions and the instructions contained in Army Technical Manuals 9-2320209-10 and 9-2320-209-20 are published for use by personnel to whom the Ward LaFrance Fire Truck is issued. They provide information on the operation and organizational maintenance of the equipment. Also included are descriptions of main units and their functions in relationship to other components.

b. Appendix A contains a list of publications applicable to this manual. Appendix B contains the list of basic issue items authorized for the operator of this equipment and the list of maintenance and operating supplies required for initial operation. Appendix C contains the maintenance allocation chart.

c. Numbers in parentheses following nomenclature callouts on illustrations indicate quantity; numbers preceding nomenclature callouts indicate preferred maintenance sequence.

d. Report of errors, omissions, and recommendations for improving this publication by the individual user is encouraged. Reports should be submitted on DA Form 2028 (Recommended Changes

to DA Publications) and forwarded direct to Commanding General, U.S. Army Mobility Equipment Command, ATTN: AMSME-MPP,,4300 Goodfellow Boulevard, St. Louis, Missouri 63120.

e. Report all equipment improvement recommendations as prescribed by TM 38-750.

1-2. Record and Report Forms

a. DA Form 2258 (Depreservation Guide for Vehicles and Equipment).

b. For other record and report forms applicable to operator, crew, and organizational maintenance, refer to TM 38-750.

Note Applicable forms, excluding Standard Form 46 (United States Government Motor Vehicles Operator's Identification Card) which is carried by the operator, shall be kept in a canvas bag mounted on equipment.

Section II. DESCRIPTION AND TABULATED DATA

1-3. Description

a. *General.* The Class 530B Fire Truck (fig. 1-1 and 1-2) is the Army's standard tactical type fire apparatus and is designed for combating structural, brush and aircraft crash fires in areas of combat operations. The fire fighting apparatus is mounted on the Army's standard 21/2 Ton, 6x6, Truck Chassis, Model M45A2. The truck is powered by a multifuel engine with a five speed forward and one reverse speed transmission. The truck is designed for use over all types of roads, highways and cross-country terrain. For additional information covering Model M45A2 Truck Chassis, refer to TM 9-2320-209-10 and -20. The Fire Truck is equipped with a

midship-mounted fire pump which is driven from a power takeoff, connected to the transfer case. The Fire Truck has the capability of pumping from a draft water supply, a hydrant water supply or from a 400 gallon water tank mounted on the truck. The Fire Truck does not have the pump-in-motion capability. The fire pump is equipped with a pressure relief valve to protect the pump, engine and hose lines against damage due to excessive pressure rise when nozzles are shut off. A priming pump is provided for priming the fire pump. The Fire Truck is also equipped with an around-the-pump liquid foam proportioning system for use in combating

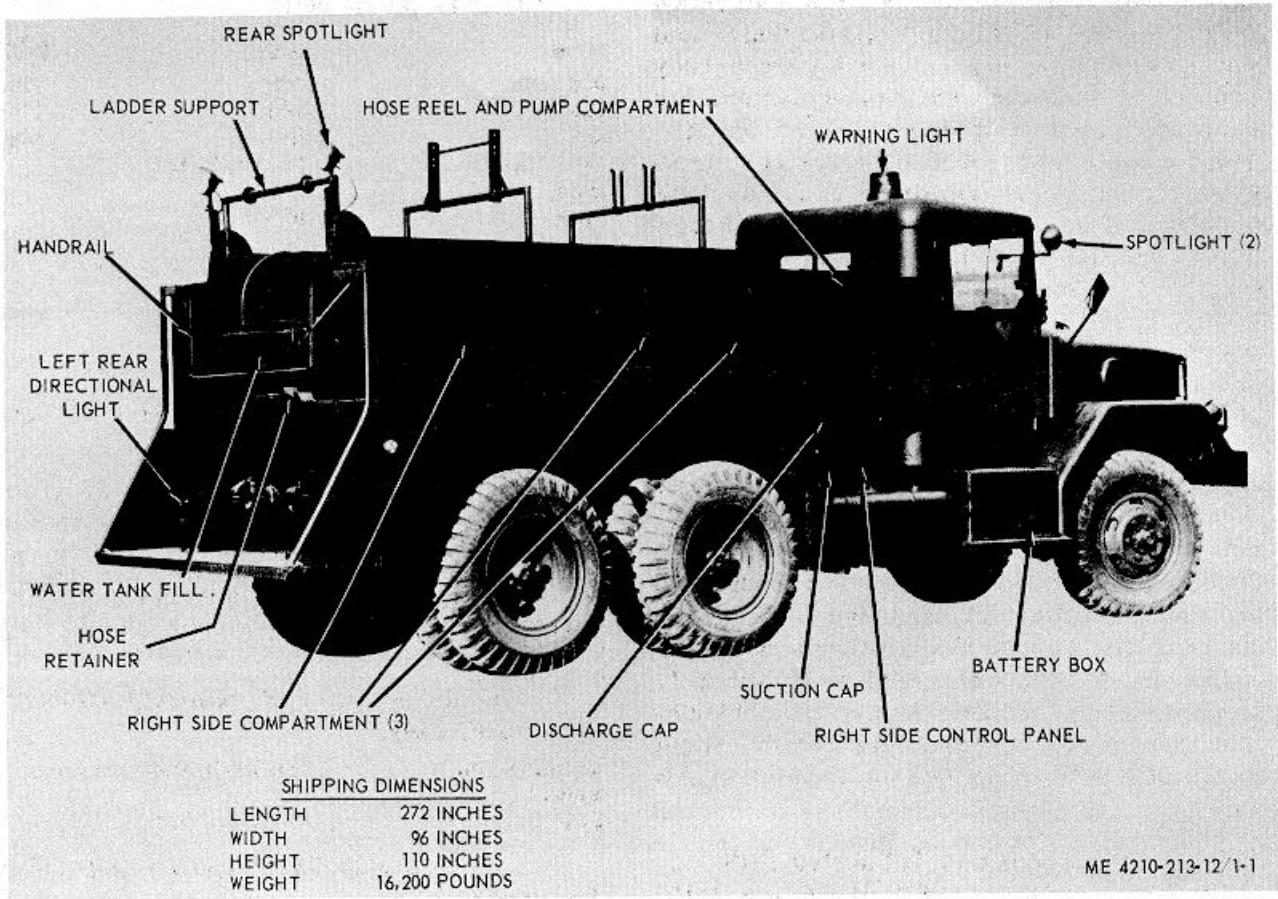

Figure 1-1. Fire truck, right-rear, three-quarter view with shipping dimensions

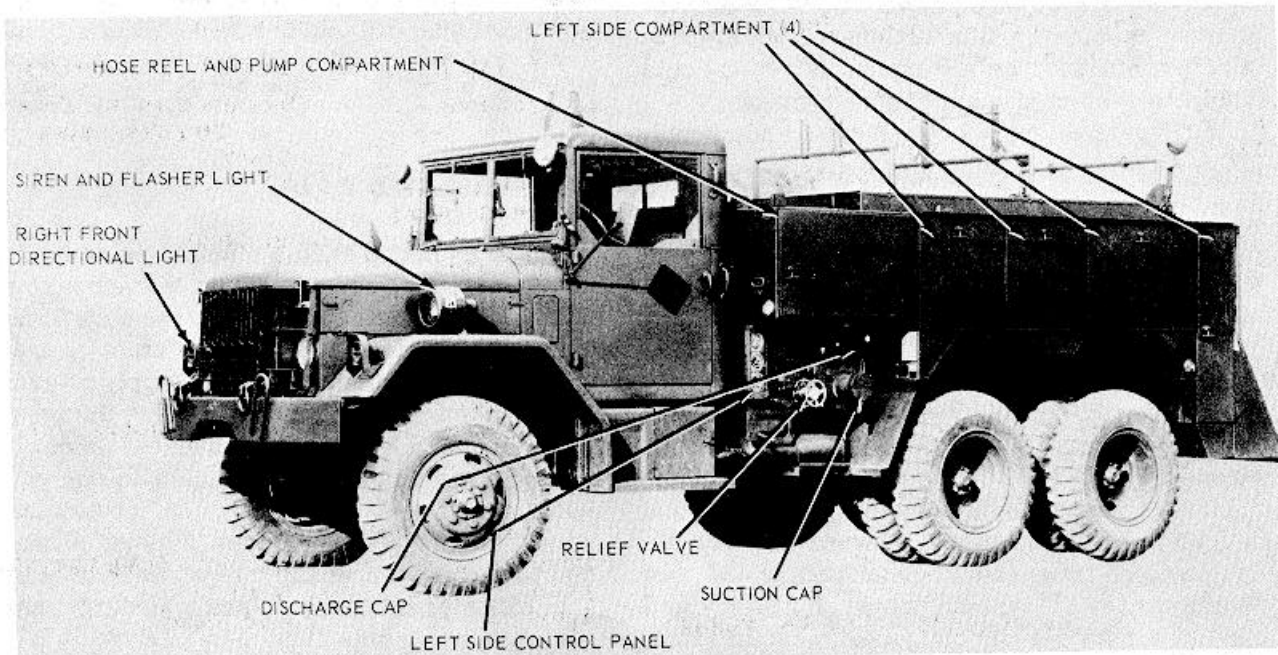

Figure 1-2. Fire truck, left-front, three-quarter view.

class B fires. The system consists of a 40 gallon foam tank, an eductor, a metering valve and related piping. A special purpose truck body is provided for transporting personnel and fire fighting equipment to the scene of the fire. The nonwinterized model fire truck is suitable for operations at temperatures to minus 26°F for a period not exceeding three hours. Portable fire fighting equipment such as hoses, nozzles, ladders, etc., are not supplied with the fire truck but are supplied as components of the fire fighting equipment sets listed in appendix A. The fire truck is also a component of the fire fighting equipment sets.

b. Color. The standard color for the class 530B fire truck when assigned to tactical use is semigloss olive drab, color chip X24087, FED STD 595, paint conforming to specification TT-E529. When the fire truck is assigned to a nontactical use or to R and U activities, the vehicle will be painted gloss red, color chip 11136, FED STD 595, paint conforming to specification TT-E-489. Using organizations are responsible for repainting the fire truck to conform with the color requirements of AR 746-5.

1-4. Identification and Tabulated Data

a. Identification. The fire truck has three major identification plates. The information contained on the plates is listed below.

(1) Truck, Fire Fighting Pumper-500 GPM-21/2 Ton 6X6.

Model.....M45A2WLF
 Serial.....00000
 Reg. No.....00000
 FSN.....4210-928-3515
 Eng. Serial.....00000
 Warranty.....0-0-00 or 0,000
 Date shipped.....0-0-00
 Manufactured by.....Ward LaFrance Truck Corp.
 Con. No.....00000
 Capacity.....5000 lbs.
 GVW.....21200 lbs.
 Date mfd.....0-0-00
 Ship wt.....16300 lbs.
 Lg.272 in.
 Height.....110 in.
 Width.....96 in.
 Cube.....1662 ft.
 Insp. Stamp.....00000

(2) Chassis plate. Refer to TM 9-2320- 209-10.

(3) Fire pump plate.

	<i>ENG.</i>	
<i>G.P.M.</i>	<i>PRES.</i>	<i>R.P.M.</i>
500	120	1550
250	200	1775
167	250	1980
Gov. Speed.....	2600 R.P.M.	
Pump ratio.....	1:2.28	
Spec.....	00000	
Year.....	0000	
Pump type.....	GSAL GS-16D-9-5	
Pump serial No.....	00000	

b. Tabulated Data.

(1) Fire truck.

Manufacturer.....Ward LaFrance Truck Corp.
 Model.....M45A2WLF
 Type.....Nonwinterized
 Class (military).....530B

(2) Chassis (Government furnished).

Manufacturer.....Kaiser Jeep Corporation
 Model (military).....M45A2 (Multifuel Engine)
 Additional data.....See chapter 1, section IV, TM 9-2320-209-10

(a) Power take-off assembly (Government furnished).

Manufacturer.....Rockwell Standard Corp.
 Model.....P-136
 FSN.....2520-786-0208

(b) Propeller shaft (power take-off to fire pump).

Manufacturer.....Dana Corporation
 Model.....Spicer 1350
 Type.....Slip Joint

(c) Batteries, lead-acid (2 in series).

Manufacturer.....Prestolite Company, Division of Eltra Corporation
 Model.....US-8T
 Type (SAE).....8T
 Military Standard
 Number.....MS 35001-5
 Voltage (each).....12
 Ampere-hour rating (at 20 hour rate).....200
 Ground.....Negative

(d) Engine heat exchanger.

Manufacturer.....Sen-Dure Products Inc.
 Model.....1113-1
 Type.....Liquid

(3) Fire pump.

Manufacturer.....Hale Fire Pump Company
 Model.....GSAL
 Type.....Centrifugal

Inlets (suction).....3 each; 2-4% inch diameter,
4 threads per inch American National Fire-Hose
Coupling Threads (NH)
and 1-2% inch diameter,
7% threads per inch
(NH)
Outlets (discharge).....2 each; 2% inch diameter,
7% threads per inch
(NH)
Power source.....Power Take-off connected to
chassis transfer case

(a) *Priming pump.*

Manufacturer.....Hale Fire Pump Company
Model.....SMV-24
Type.....Positive-displacement rotary vacuum pump

(b) *Priming pump motor.*

Manufacturer.....The Prestolite Company
Model.....MBY 4007T
Horsepower.....Not rated
Voltage (direct current) 24
Amperes.....40
Time rating.....Intermittent duty

(c) *Priming valve.*

Manufacturer.....Hale Fire Pump Company
Model.....PV-Plate No. 480B
Type.....Piston-Manually operated

(d) *Relief valve.*

Manufacturer.....Hale Fire Pump Company
Model.....GSA
Type.....Manually operated

(e) *Relief valve control.*

Manufacturer.....Hale Fire Pump Company
Model.....QL
Type.....Automatically operated
Range.....100 to 300 pounds

(f) *Drain valve.*

Manufacturer.....Hale Fire Pump Company
Model.....HD
Type.....Piston-manually operated

(4) *Foam proportioning system.*

Manufacturer.....Rockwood Sprinkler
Company
Model.....B-2
Type.....Around-the-pump
Solution.....Foam liquid and water

(5) *Hose reel.*

Manufacturer.....Ward LaFrance Truck
Corporation
Models.....M45P1 and M45P2
Type.....Manually or electrical
operated
Outlet connection.....1 inch diameter
8 threads per inch

Motor data.....Manufacturer-Howell
Electric Company;
Model-22047; Type-C
Horsepower %; Voltage
(direct current)-24;
Amperes-20; time Rating-5 minutes; Revolutions Per Minute-500;
Rotation-Clockwise or counter-clockwise.

(6) *Siren.*

Manufacturer.....Sireno Signal Manufacturing Company
Model.....UAL
Type.....With flasher light
Voltage (direct current) 24
Amperes.....10.0

(7) *Warning light.*

Manufacturer.....Federal Sign and Signal Corporation
Model.....17 MS
Type.....Rotating (red)
Voltage (direct current) 24
Amperes.....8.0

(8) *Spotlights.*

(a) *Front spotlight.*

Manufacturer.....Unity Manufacturing Co.
Model.....15700
Type.....Splash resistant, sealed beam, fixed focus
Voltage (direct current) 24
Amperes.....5.3
Candlepower.....130.000

(b) *Rear spotlight.*

Manufacturer.....Unity Manufacturing Co.
Model.....15600
Type.....Splash resistant, sealed beam, fixed focus
Voltage.....24
Amperes.....5.3
Candlepower.....130,000

(9) *Light engine (under hood).*

Manufacturer.....Culver Stearns Manufacturing Co.
Model.....G579A
Type.....Bulb
Voltage (direct current) 24
Amperes.....0.71

(10) *Vehicular compartment heater.*

Manufacturer.....Evans Product Company
Model.....HV220024
Type.....Hot water (engine coolant)
British thermal units
out put.....18,000
Motor data.....Voltage (direct current)-
24; amperes-4.0; speed-
single

(11) *Tachometer.*

Manufacturer.....Stewart Warner Corpora-
..... tion
Model.....569H
Type.....Combination tachometer/
..... hourmeter
Dial markings.....0 to 400 revolutions per
..... minute

(12) *Pressure gage.*

Manufacturer.....James P. Marsh Corpora-
..... tion
Model.....DFMO-400
Type.....1
Dial markings.....0 to 400 pounds

(13) *Compound gage.*

Manufacturer.....James P. Marsh Corporva
..... tion
Mode.....DFM80-150
Type.....3
Dial markings.....0 to 80 inches of Vacuum
..... (Mercury). 0-150 pounds
..... per square inch. '

(14) *Capacities.*

Chassis (fuel) tank
crankcase, radiator,
tire pressure, etc... See TM 9-220-209-10
Battery (each).....16.4 quarts Electrolt
Fire pump

<i>Gallons per Minute</i>	<i>Pressure</i>	<i>Engine rpm (revolutions per minute)</i>
500	120	1550
250	200	1775
167	250	1980

Priming tank.....6 quarts SAE No. 80
Engine Act.
Priming pump
displacement.....066 gal. per revolution

Foam proportioning system
double strength (3
percent).....400 GPM
Regular strength
(6 percent).....200 GPM
Water tank.....400 Gallons
Liquid foam tank.....40 Gallons
Hose reel (each).....150 feet 1 inch hose
Rose bed
1 1/2inch hose.....1000 feet
2 1/2 inch hose....1200 feet

(15) *Dimensions and weight (fig. 1-1).*

Length.....272 inches
Width.....96 inches
Height.....110 inches
Weight (water and foam
tanks empty, less on-
board equipment)16,200 lbs.
Weight (water and foam
tanks empty, with on-
board equipment).. 12,400 lbs.
Weight (water and foam
tanks full, with on-
board equipment).. 21,150 lbs.
Volume.....1,662 cubic feet
Angle of approach....48 Degrees
Angle of departure...24 Degrees
Ground clearance....12 inches

(16) *Wiring diagram. See figure 1-3.*

1-5. Difference in Models

This manual covers only the Ward LaFrance "Model M45A2WLF Fire Truck. No known differences exist for the model covered by this manual.

Figure 1-3. Wiring Diagram.

Located in Back of Manual

CHAPTER 2

INSTALLATION AND OPERATING INSTRUCTIONS

Section I. SERVICE UPON RECEIPT OF EQUIPMENT

2-1. Unloading Equipment

a. General It is the responsibility of the Organizational Maintenance Unit or the receiving organization to unload the equipment from carrier.

b. Preparation for Unloading.

- (1) Remove the blocking from the wheels.
- (2) Remove tiedowns from wheels and axles.
- (3) Remove blocking from under the axles.

Note

To remove blocking, place jack under axle.

c. Unload by Towing.

(1) Connect towbar, chain or cable from tow truck to the front, lifting shackles of fire truck (fig. 105, TM 9-2320-209-10).

(2) Man the cab of fire truck. Depress clutch pedal and make certain that transfershift lever and transmission gearshift lever are in the neutral positions. Release parking brake by pushing the parking brake lever downward.

(3) When descending loading ramp, brake the fire truck by pulling upward on the parking brake lever.

Caution

The service brakes of the fire truck are inoperative when the engine is not running.

2-2. Unpacking Equipment

a. Unpacking. Open the packing containers shipped on board and display the contents for inspection.

Note

Do not remove electrolyte from containers until ready for use.

b. Depreservation. Prepare the fire truck for inspection and servicing by deprocessing the vehicle as outlined in chapter 2 TM 9-2820209-20 and as outlined, on DA Form 2258 (Depreservation Guide). This Form is generally attached to steering wheel, shifting levers or ignition switch.

2-3. Inspecting and Servicing Equipment

a. Inspecting.

(1) Make a thorough visual inspection of the fire truck for damage that may have occurred during shipment. Inspect components for loose mounting and missing mounting hardware.

(2) Inspect the packing list and make sure all equipment listed has been received.

(3) Inspect the truck chassis TM 9-2320-209-10.

b. Servicing.

Note

Make sure equipment is completely de-processed before servicing. Make sure preservations have been removed from such items as crankcase, fuel tank, gearboxes, and the like.

(1) Perform the daily and quarterly maintenance service (para 3-6 and 3-7).

(2) Lubricate the truck chassis (LO 92320-209-12).

(3) Fill the truck cooling system (TM 9-2320-209-10).

(4) Fill the fuel tank (TM 9-2320-20910).

Table 2-1. Freezing Points, Composition, and Specific Gravities of Military Antifreeze Materials.

Lowest expected ambient temp. F	Pints of inhibited glycol per gal. of coolant	Compound, Antifreeze Arctic ²	Ethylene glycol coolant solution specific gravity at 68°F ³
+20	1%	Issued full strength and ready mixed for 0 to -65° temperatures for both initial installation and replenishment of losses.	1.022
+10	2		1.036
0	2%		1.047
-10	314		1.055
-20	3%		1.062
-30	4		1.067
-40	4 A	DO NOT DILUTE WITH WATER OR ANY OTHER SUBSTANCE	1.073
-50	Arctic		
-60	Anti-freeze		
-75	pre-ferred		

¹ Maximum protection is obtained at 60 percent by volume (4.8 pints of ethylene glycol per gallon of solution).

² Military Specifications MIL-C-11755 Arctic type, nonvolatile anti-freeze compound is intended for use in the cooling system of liquid-cooled internal combustion engines. It is used for protection against freezing primarily in Arctic regions where the ambient temperature remains for extended periods close to -40°F or drops below, to as low as -90° F.

³ Use an accurate hydrometer. To test hydrometer, use 1 part ethylene glycol antifreeze to 2 parts water. This should produce a hydrometer reading of 0° F.

Note

Fasten a tag near the radiator filler cap indicating the type antifreeze.

2-4. Installation of Separately Packed Components

- a. Batteries are shipped dry and must be activated by adding electrolyte.
- b. Check batteries for cracks, and terminal

Section II. MOVEMENT TO A NEW WORKSITE

2-6. Dismantling for Movement

a. The fire truck requires no disassembly other than the safe and proper storage of hoses, ladders, hose connections, adapters, and accessories for movement to a new worksite.

b. Disconnect the battery cables and drain the fuel (TM 9-2320-209-10) in the event the fire truck is moved by some means other than its own power.

Caution

Do not exceed 20 mph on good hard surface roads or 10 mph on secondary roads or across country when towing the fire truck.

Section III. CONTROLS AND INSTRUMENTS

2-8. General This section describes, locates, illustrates, and furnishes the operator, crew or organizational maintenance personnel sufficient information about the various controls and instruments for proper operation of the fire truck.

Section IV. OPERATION OF EQUIPMENT

2-10. General

a. The instructions in this section are published for the information and guidance of the personnel responsible for operation of the fire truck.

b. The operator must know how to perform every operation of which the fire truck is capable. This section

corrosion. Clean battery exterior surfaces with a bristle brush dipped in ammonia or soda water. Place batteries in the battery box and attach the terminals.

Warning

Do not smoke or use an open flame in the vicinity when servicing the batteries. Batteries generate hydrogen, a highly explosive gas. Electrolyte is an acid and should be handled with care. If the electrolyte should come in contact with the skin, wash with soap and water.

c. Refer to TM 9-2320-209-10 for installation instructions for the air cleaner bonnet, windshield wipers and rear rearview mirror.

2-5. Installation or Setting up Instructions

The fire truck will be received completely assembled and ready for use, except for servicing the batteries.

- c. Drain the water tank and foam tank (para 215).
- d. Lock the hose reel assemblies (fig. 2-10).

2-7. Reinstallation After Movement

- a. Fill the water tank and foam tank (para 2-13).
- b. Service the carrier's fuel system (TM 9-2320-209-10).
- c. Connect tie battery cables to the batteries (TM 9-2320-209-10).

2-9. Controls and Instruments The purpose, location and use of the controls, instruments and gages are illustrated on figure 2-1. Refer to TM 9-2320-209-10 for chassis and engine controls and instruments.'

gives instructions on starting and stopping the fire truck, on the basic motions to perform the specific tasks for which the equipment is designed. Since nearly every job presents a different problem, the operator may have to vary given procedure to fit the individual job.

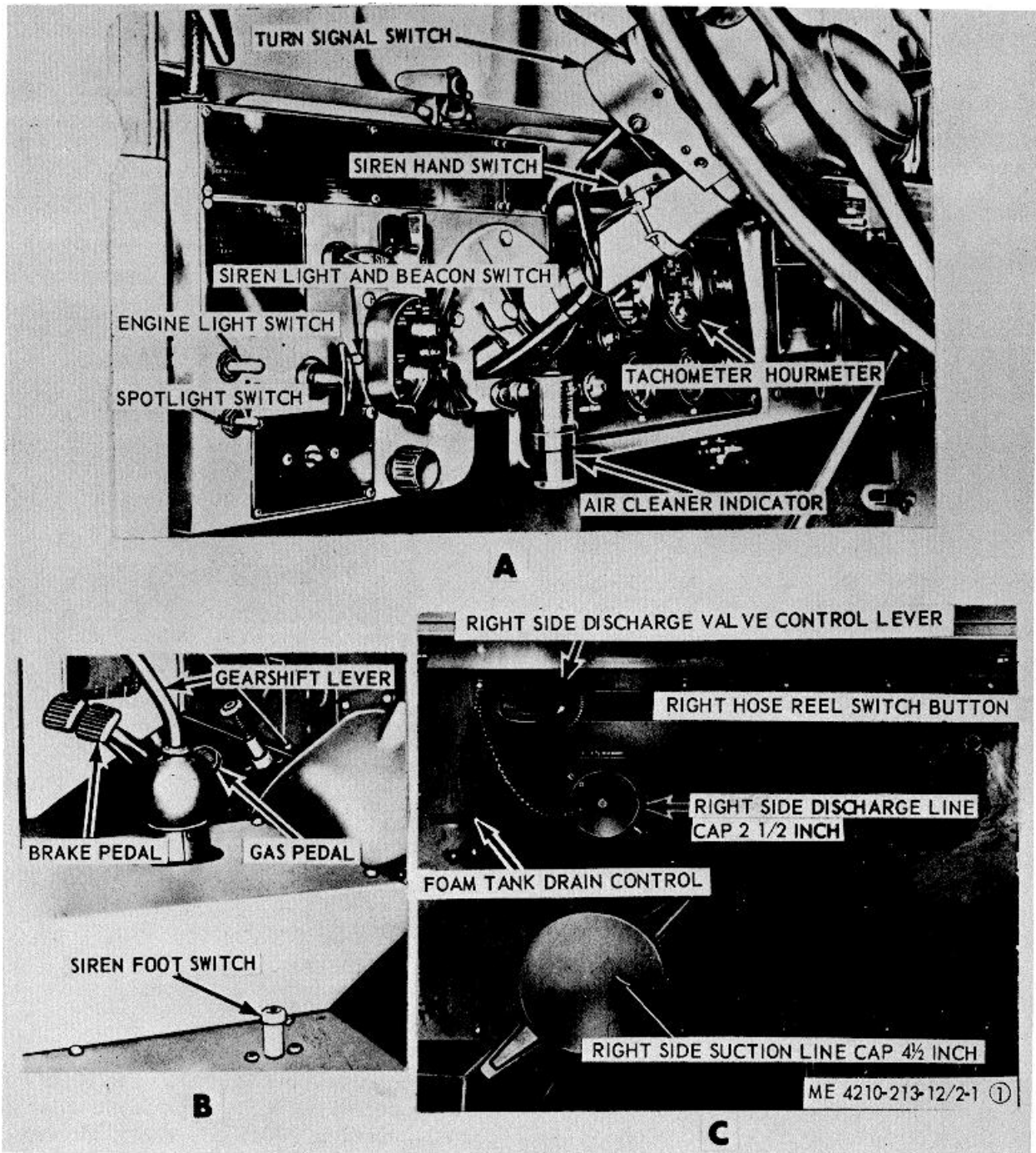

Figure 2-1. Controls and instruments.

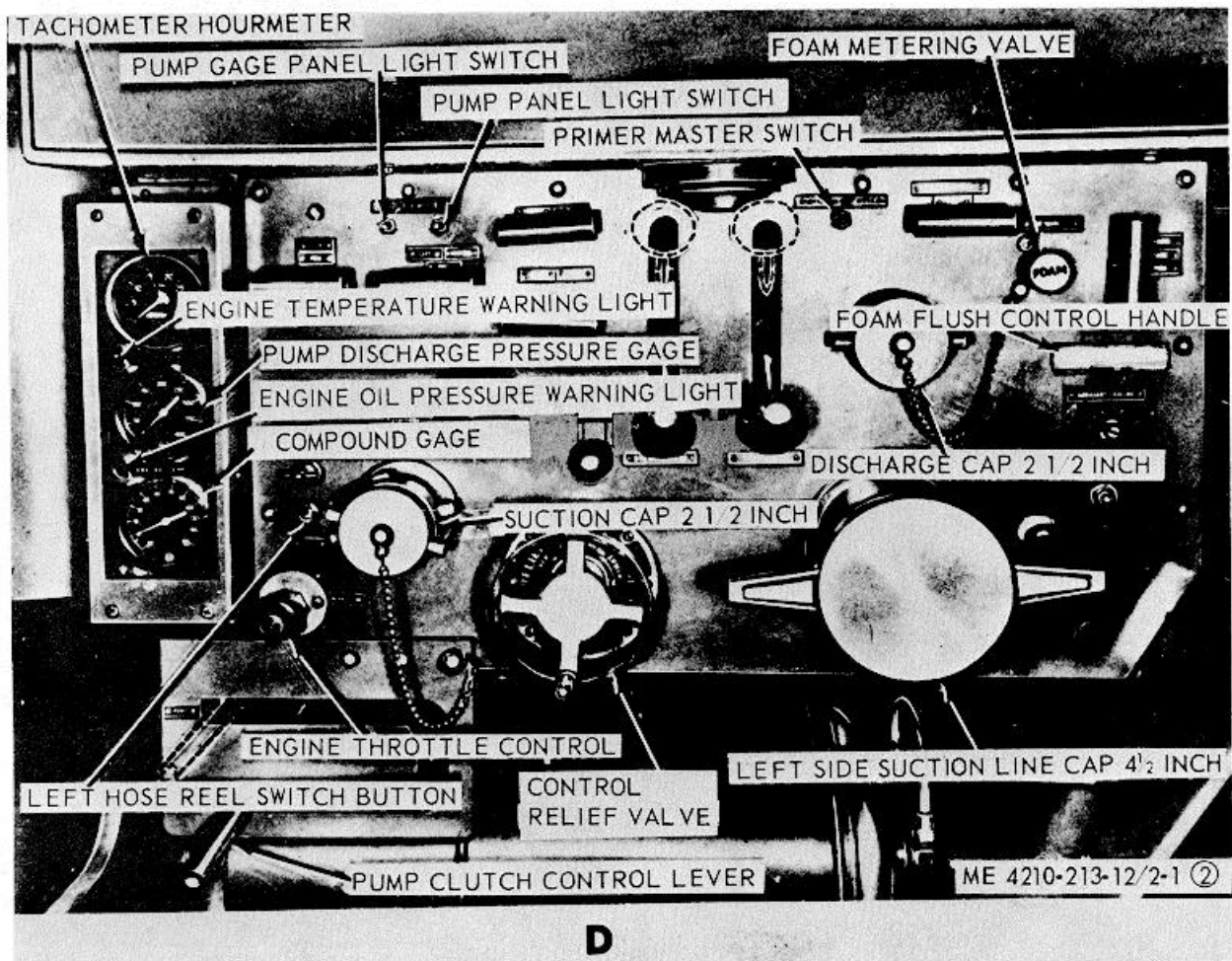

Figure 2-1-Continued.

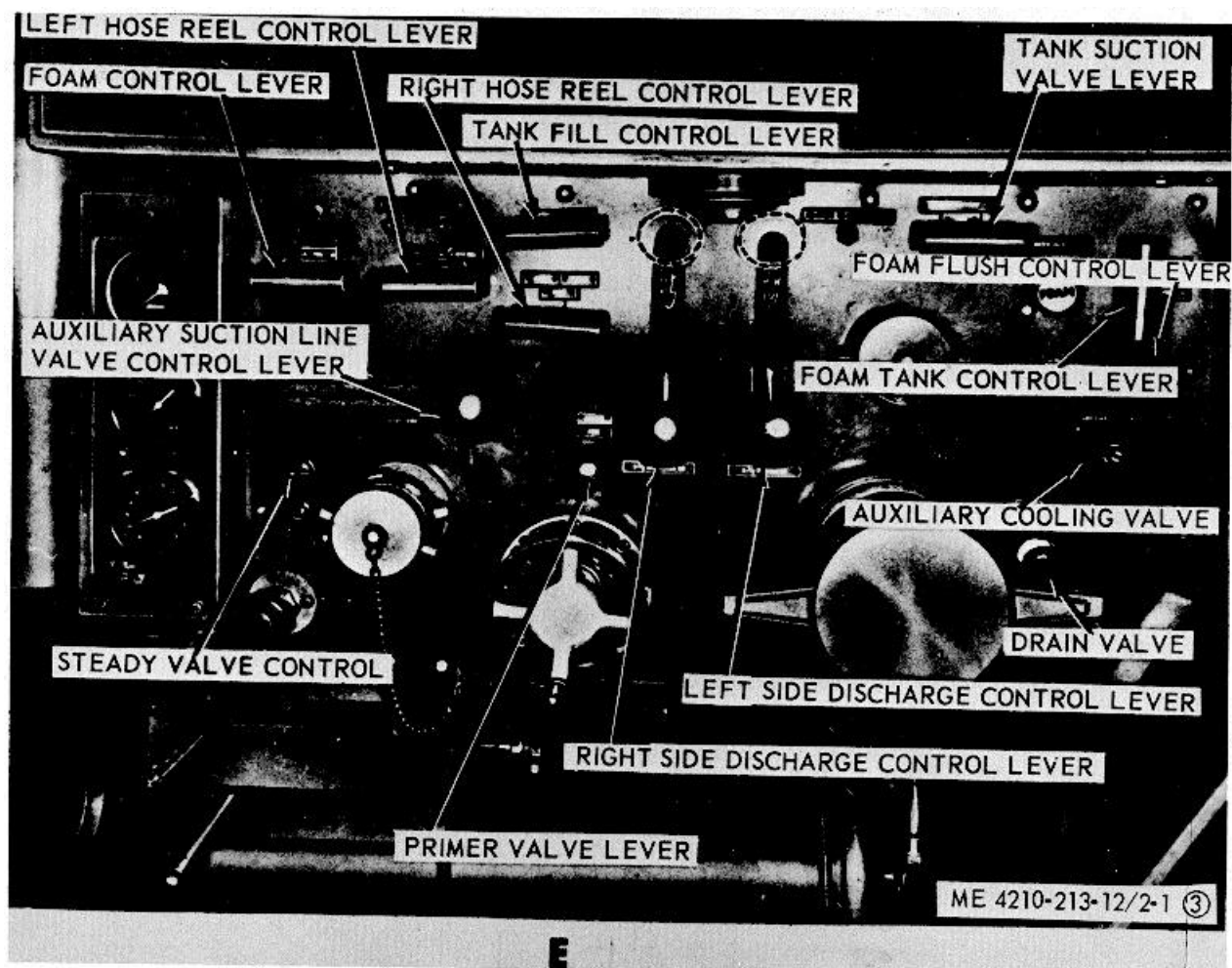

Figure 2-1-Continued.

2-13. Priming Fire Pump and Filling Tanks

- a. *Priming Fire Pump.* Refer to figure 2-2 and prime the fire pump.
- b. *Filling the 400-Gallon Water Tank from Suction Lift.* Refer to figure 2-3 and fill the 400-gallon water tank.
- c. *Filling the 400-Gallon Water Tank Through the Water Tank Fill.* Refer to figure 2-4 and fill the water tank through water tank fill.
- d. *Filling the 400-Gallon Water Tank From a Hydrant.* Refer to figure 2-5 and fill the 400-gallon water tank from a hydrant.
- e. *Filling 40-Gallon Foam Tank With Concentrate.* Refer to figure 2-6, 2-7 and fill the 40-gallon foam tank with concentrate.

2-14. Pumping Details

- a. Pumping water from suction lift. Refer to figure 2-8 and pump water from suction lift.
- b. Pumping water from the 40-gallon tank (para 2-13).
 - (1) Water may be pumped either independently to one, or to all of the outlets after removing the discharge caps and connecting hoses.
 - (2) Prime the fire pump from the water tank (para 2-13).
 - (3) Follow steps 4 through 7, figure 2-8 outlined in pumping from suction lift to pump water from the water tank.
- c. Pumping water from hydrant. Refer to figure 2-9 and pump water from hydrant.

Note

If possible, flush dirt from hydrant before attaching hose.

- d. Pumping water from the hose reels. Refer to figure 2-10 and pump water from hose reels.
- e. Pumping foam. Refer to figure 2-11 and pump foam from foam tank.

2-15. Draining and Flushing Details

- a. Draining fire pump and lines. Refer to figure 2-2 and drain the fire pump, valves and lines.
- b. Draining the water tank. Refer to figure 2-2 and drain the 400-gallon water tank.
- c. Draining and flushing the 40-gallon foam concentrate tank. Refer to figure 2-12 and drain and flush the 40-gallon foam concentrate tank.
- d. Flushing discharge line system. Refer to figure 2-12 and flush the discharge line system.

2-16. Final Test Before Housing Fire Truck After Returning From Fire

- a. Perform daily preventative maintenance services (para 3--6).
- b. Close all controls and valves and have suction caps tight.
- c. Pull primer valve lever and run until combination gage shows about 15 inches of vacuum in 15 seconds.
- d. Close primer valve lever and watch gage. If vacuum falls rapidly it indicates air leakage.
- e. Test suction hose by attaching suction hose to pump and placing suction tube cap on end of suction hose in place of strainer and i test for leaks.
- f. Repair leaks or report to direct support maintenance.

2-17. Operation Under Usual Conditions

Start and operate the fire truck and equipment as described in section IV.

2-18. Operation in Extreme Cold (Below 0° F.)

a. *General.* Operation in extreme cold temperatures creates special problems which require careful inspection and maintenance. Personnel should be especially careful not to subject the fire truck to any sudden shocks, loads or rough handling which might strain the equipment and crack or break metal parts. Do not allow water to spray over the body of the truck or the compartment doors' will freeze shut. All operations must be started carefully at slow speeds. AH controls, linkage, frame mountings, and drive parts must be carefully inspected for damage. Refer to TM 9-2320209-10 for additional information on operating the fire truck in extremely cold temperatures.

b. *Lubrication.* Be sure to use the correct grade of lubricant for all points of application. Refer to LO 9-2320-235-12 and LO 5-4210-213-12 for special cold weather lubrication instructions.

c. *Hose Nozzle and Hoses.* If the hose nozzles are closed in extremely cold weather, water in the hoses and nozzles freezes rapidly. Immediately after pumping, detach the nozzles and drain the hose. If possible, dry the hose before stowing to prevent freezing.

d. *Pump Lines* Drain water from pump and

DRAINING

TURN HANDLE COUNTERCLOCKWISE TO DRAIN WATER TANK.
AFTER DRAINING, FLUSH WITH CLEAN WATER.

NOTE: TURN HANDLE CLOCKWISE TO CLOSE VALVE.

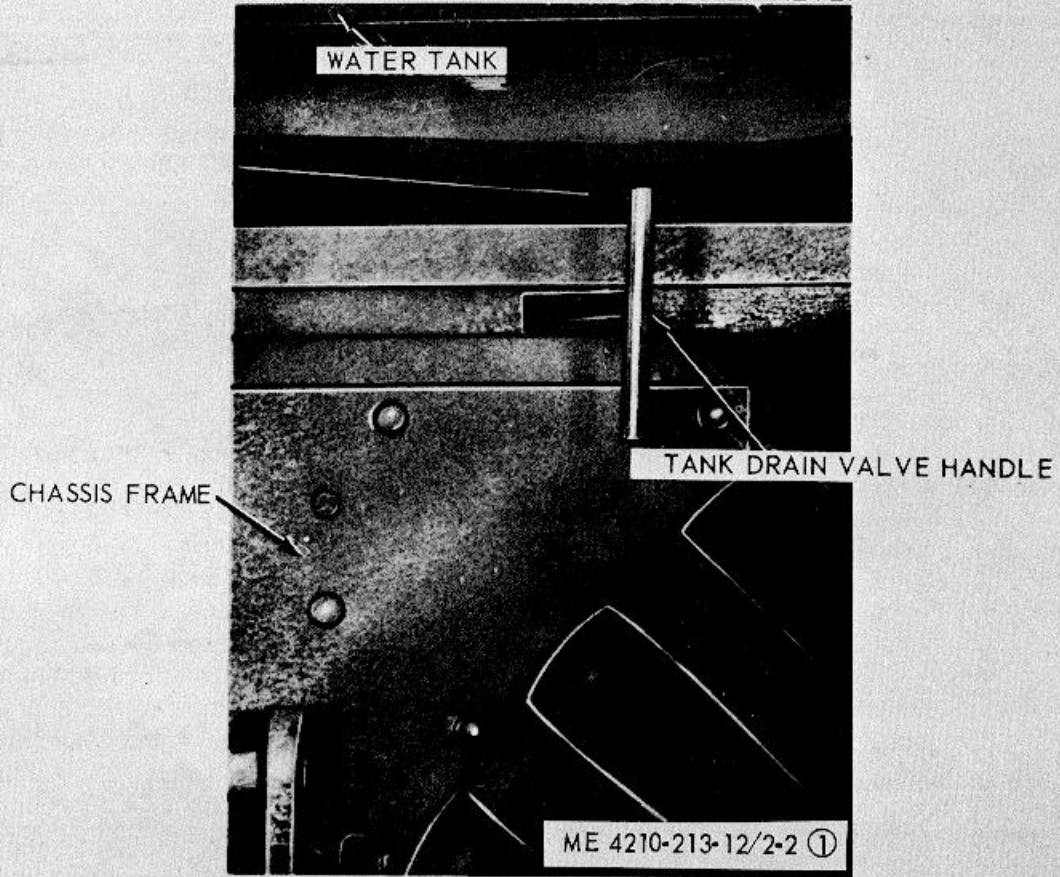

Figure 2-2. Priming pump details.

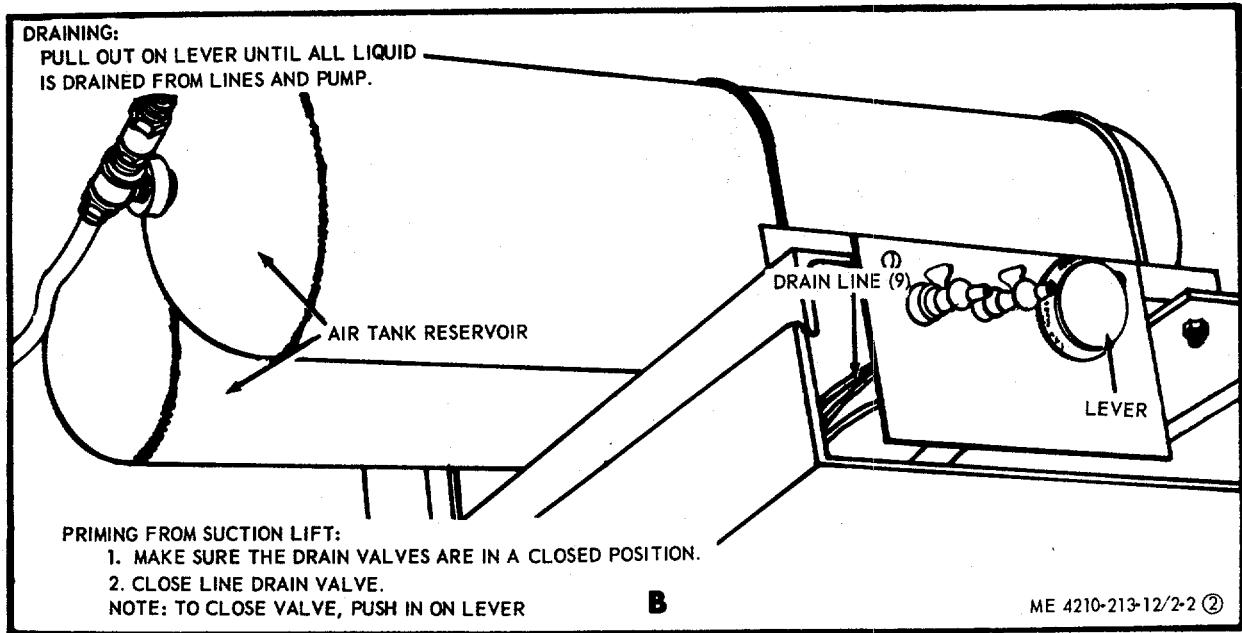

Figure 2-2-Continued.

3. START ENGINE (Par. 2-11)
4. DEPRESS CLUTCH PEDAL AND PLACE TRANSFER SHIFT LEVER IN NEUTRAL POSITION.
5. MOVE TRANSMISSION GEARSHIFT LEVER INTO 4TH SPEED.
6. RELEASE CLUTCH PEDAL AND ENGAGE HAND BRAKE LEVER.

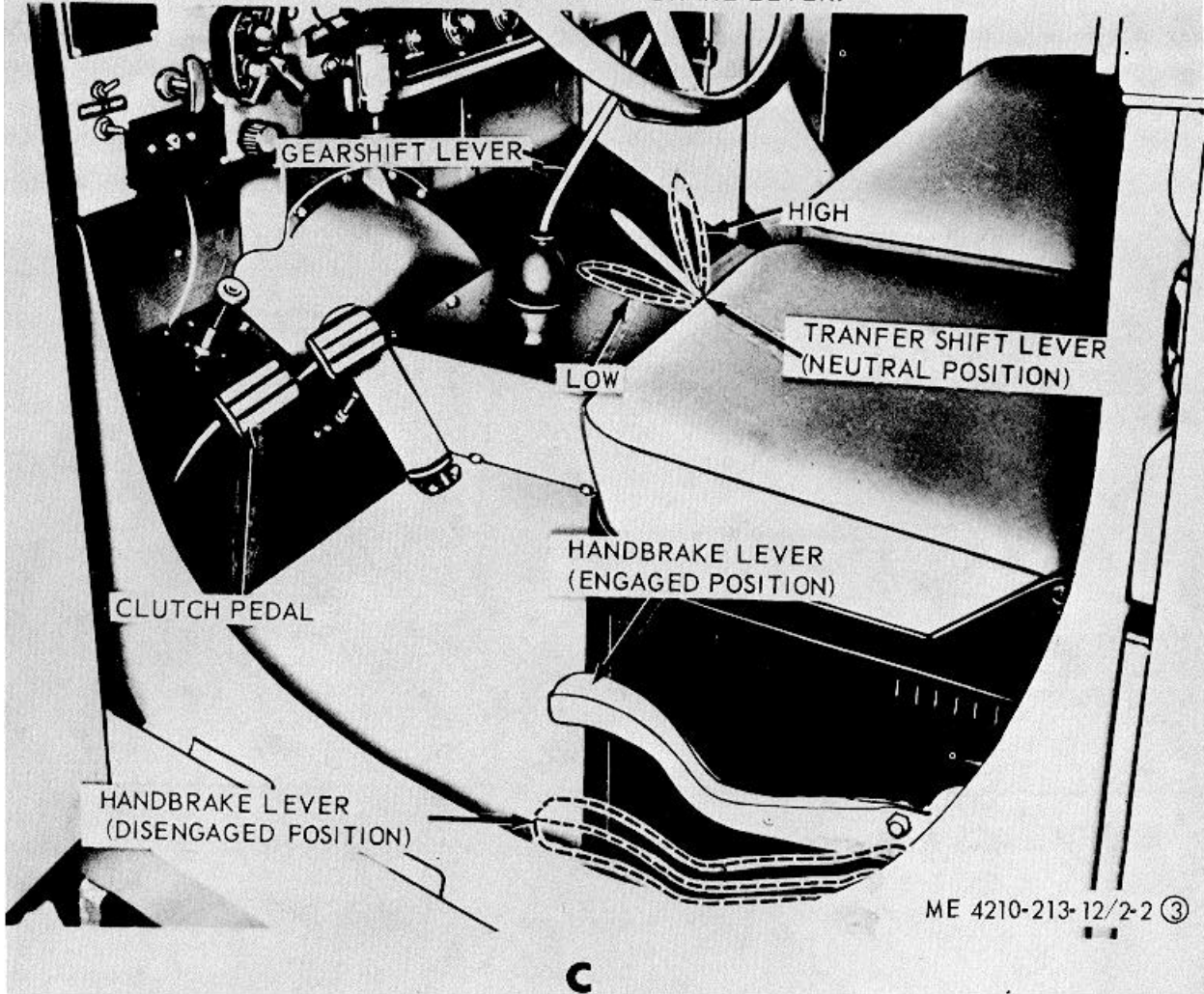
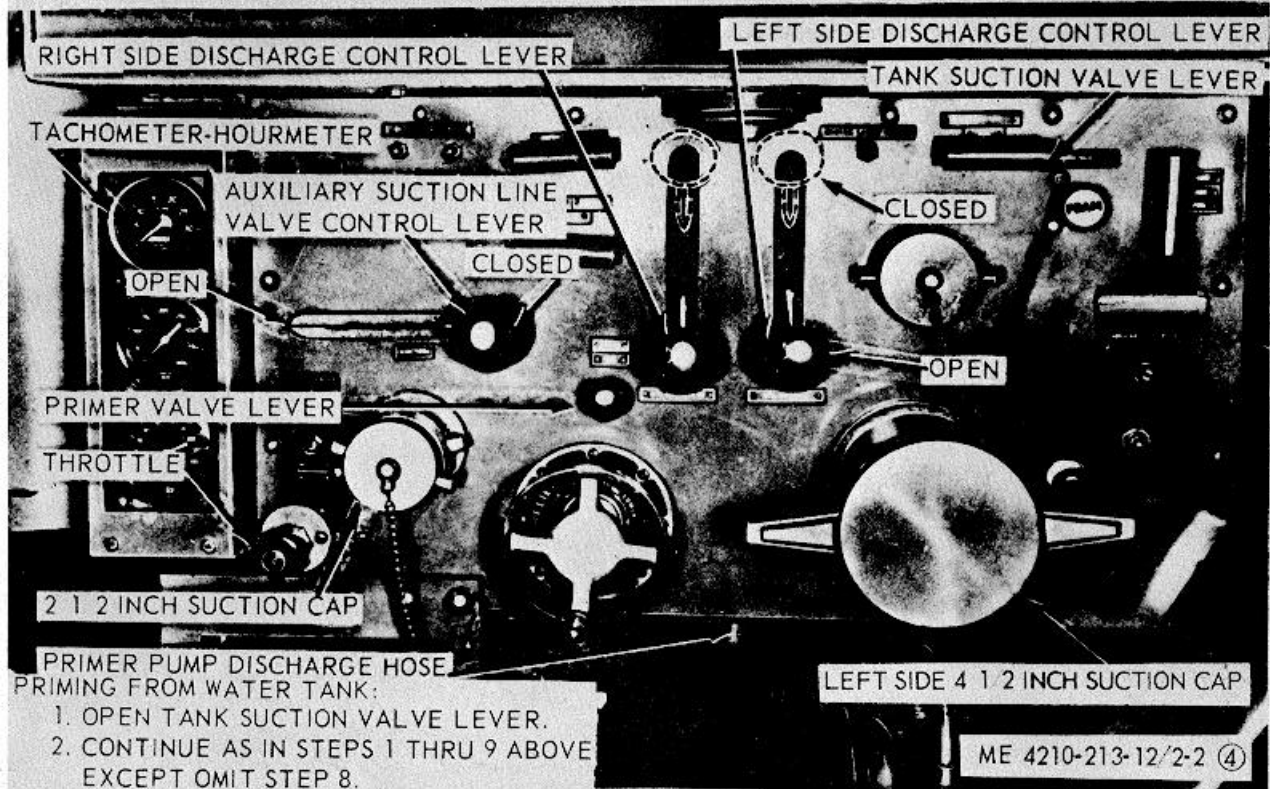

Figure 2-2-Continued.

7. ALL CONTROLS AND VALVES SHOULD BE IN CLOSED POSITION.
8. REMOVE SUCTION CAPS FROM LEFT OR RIGHT SIDE AS DESIRED AND ATTACH ONE END OF THE SUCTION HOSE TO FIRE PUMP SUCTION INLET AND PLACE APPROPRIATE END WITH STRAINER ATTACHED IN WATER.
NOTE: WHEN USING THE 2 1/2 INCH SUCTION, OPEN THE AUXILIARY SUCTION LINE VALVE LEVER.
CAUTION: SEE THAT THE STRAINER AT LOWER END OF HOSE IS AT LEAST 2 FEET BELOW WATER SURFACE TO AVOID TAKING AIR BUT FAR ENOUGH FROM BOTTOM TO PREVENT PUMPING SAND AND OTHER FOREIGN MATERIAL.
9. PULL PRIMER PUMP LEVER ALL THE WAY OUT. HOLD IN POSITION UNTIL DISCHARGE HOSE IS FREE OF AIR AND WATER STARTS TO DISCHARGE.
CAUTION: IF PRIMING PUMP DOES NOT DISCHARGE WATER IN 10 TO 30 SECONDS PUSH PRIMER LEVER IN AND LOOK FOR AIR LEAKS.
NOTE: RIGHT HAND DISCHARGE VALVE CAN BE OPERATED FROM EITHER LEFT OR RIGHT HAND OPERATORS CONTROL PANEL.



- PRIMING FROM WATER TANK:
1. OPEN TANK SUCTION VALVE LEVER.
 2. CONTINUE AS IN STEPS 1 THRU 9 ABOVE EXCEPT OMIT STEP 8.
- PRIMING FROM HYDRANT:

1. REMOVE DESIRED SUCTION CAPS AND CONNECT ONE END OF HOSE WITH STRAINER TO SUCTION LINE AND OTHER END WITH HYDRANT.
2. CONTINUE AS IN STEPS 1 THRU 7 (PRIMING FROM SUCTION LIFT ABOVE).
NOTE: DO NOT PULL PRIMER VALVE LEVER. PRESSURE FROM HYDRANT WILL FORCE WATER INTO PUMP.
3. OPEN HYDRANT.

D

Figure 2-2-Continued.

1. MAKE SURE ALL VALVES AND CONTROLS ARE IN CLOSED POSITION.
 2. OPEN THE WATER TANK FILL COVER AT REAR OF TANK.
 3. PRIME THE WATER PUMP FROM SUCTION LIFT (Fig. 2-2)
 4. MOVE PUMP CLUTCH CONTROL LEVER FROM ROAD TO PUMP POSITION.
 5. FILL THE WATER TANK BY OPENING THE TANK FILL CONTROL LEVER.
- NOTE:** TANK OVERFLOW IS ON FRONT LEFT CORNER OF TANK WITH DISCHARGE PIPE RUNNING UNDER THE TRUCK.

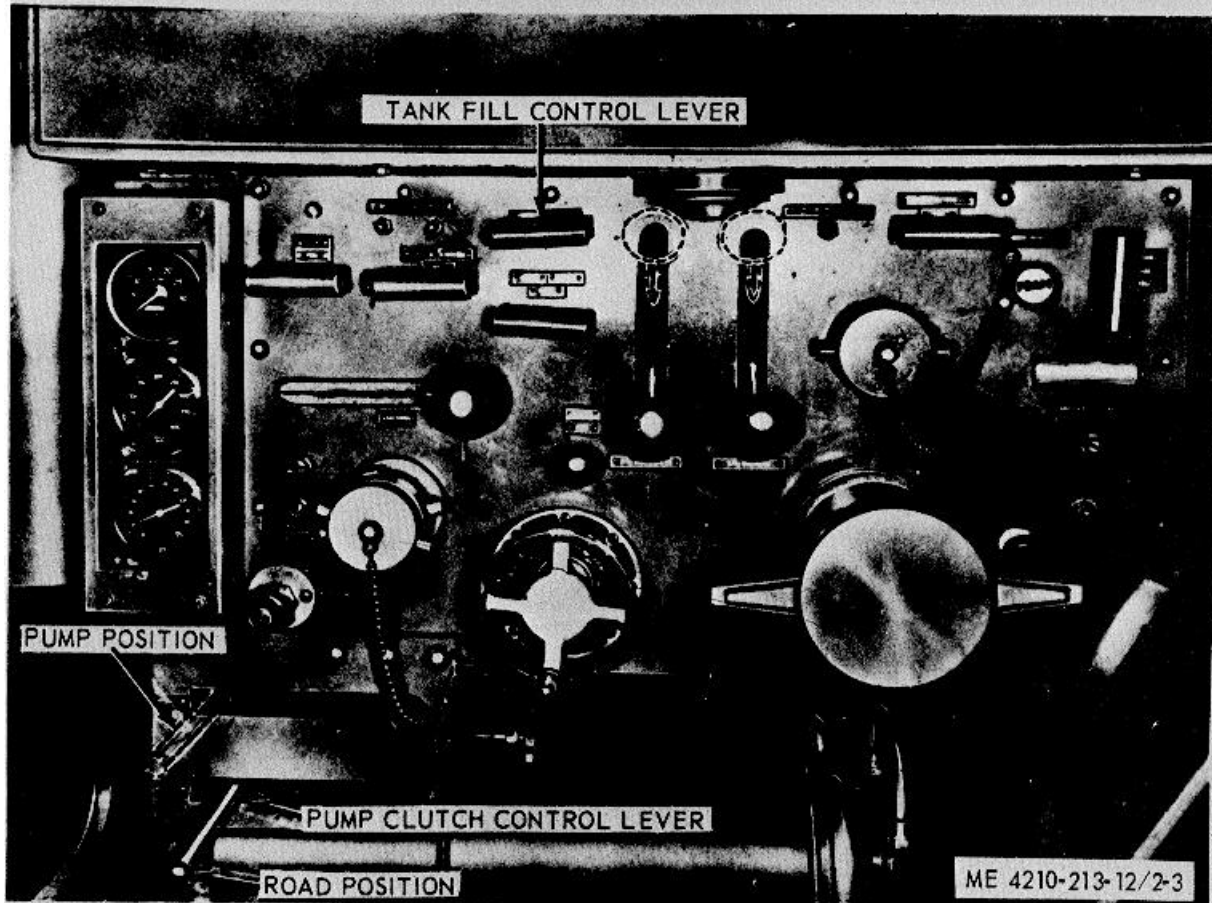

CAUTION: THE PUMP CLUTCH CONTROL LEVER MUST BE IN THE ROAD POSITION WHEN WATER IS NOT BEING DISCHARGED.

Figure 2-3. Filling water tank from suction lift.

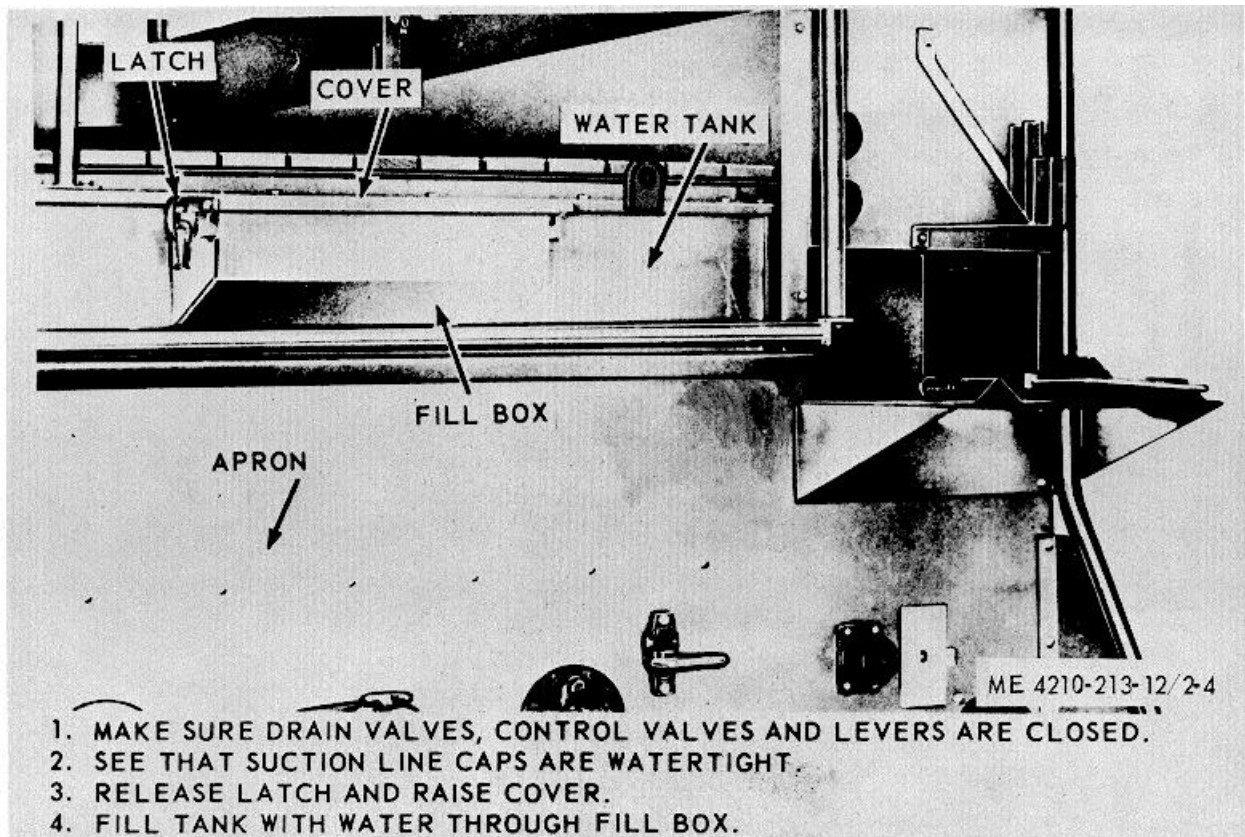
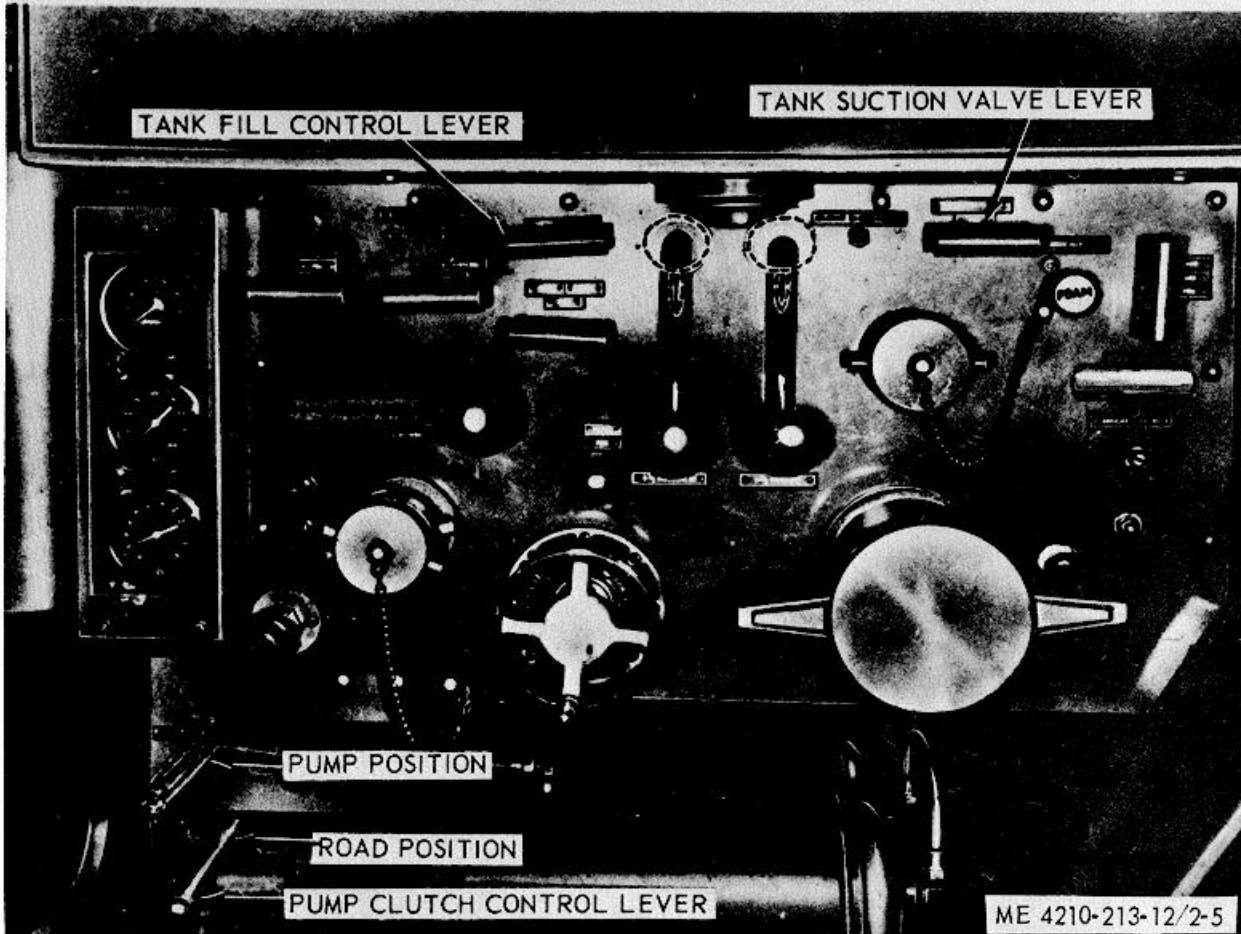

Figure 2-4. Filling water tank with bucket.

1. MAKE SURE DRAIN VALVES AND CONTROL VALVE LEVERS ARE CLOSED.
 2. RELEASE LATCH AND OPEN FILL BOX COVER.
 3. CONNECT SUCTION HOSES BETWEEN PUMP SUCTION INLET AND HYDRANT.
 4. OPEN HYDRANT.
 5. OPEN TANK FILL AND SUCTION VALVE LEVERS.
- NOTE: IF A 2 1/2 INCH AUXILIARY SUCTION IS USED THE AUXILIARY SUCTION CONTROL LEVER MUST ALSO BE OPENED.



CAUTION: THE PUMP CLUTCH CONTROL LEVER MUST BE IN THE ROAD POSITION. WHEN WATER IS NOT BEING DISCHARGED.

Figure 2-5. Filling water tank from hydrant.

NOTE: ALWAYS FLUSH THE FOAM SYSTEM AS SOON AS IT IS DRAINED UNLESS IT IS TO BE IMMEDIATELY REFILLED.

DRAINING: PLACE A SUITABLE CONTAINER UNDER FOAM TANK AND OPEN DRAIN VALVE.

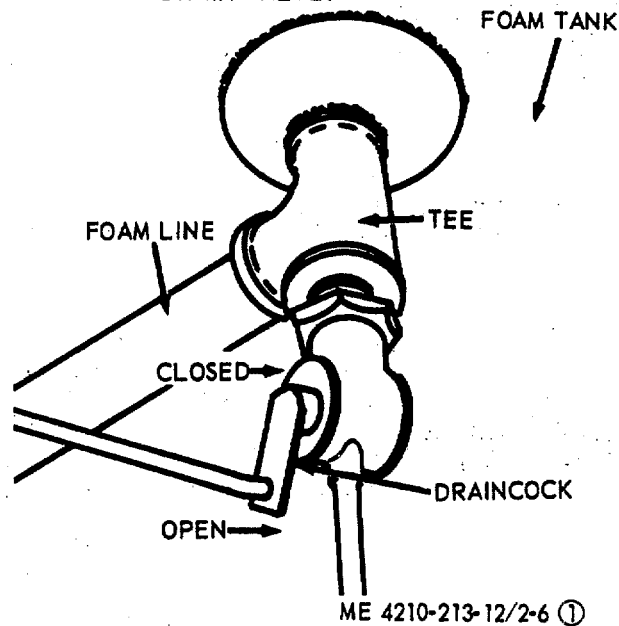

1. MAKE SURE FOAM TANK DRAINCOCK IS IN CLOSED POSITION.
2. MAKE SURE ALL VALVES ARE IN CLOSED POSITION.

A

Figure 2-6. Foam tank filling details.

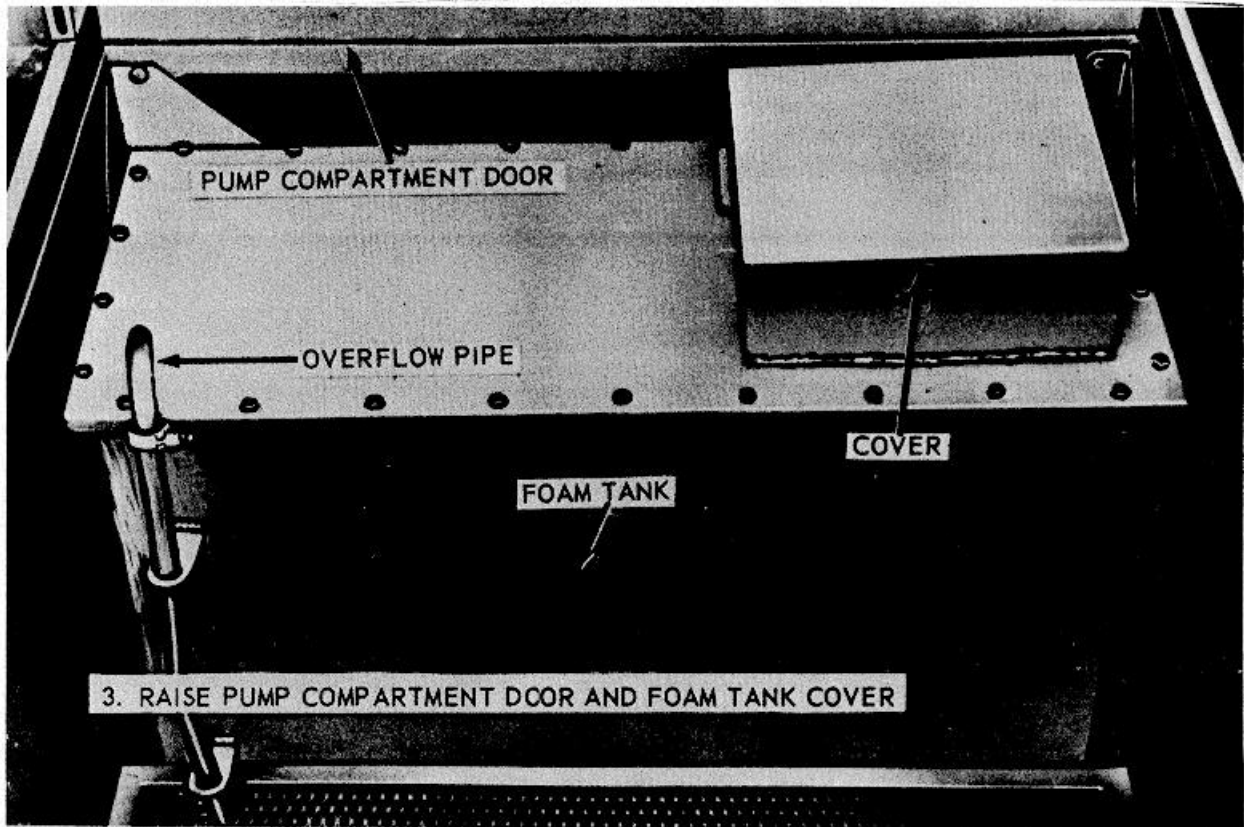

B

STRAINER SERVICE: REMOVE FOUR SCREWS AND STRAINER. CLEAN STRAINER WITH AN APPROVED CLEANING SOLVENT. REPLACE STRAINER AND FOUR SCREWS.

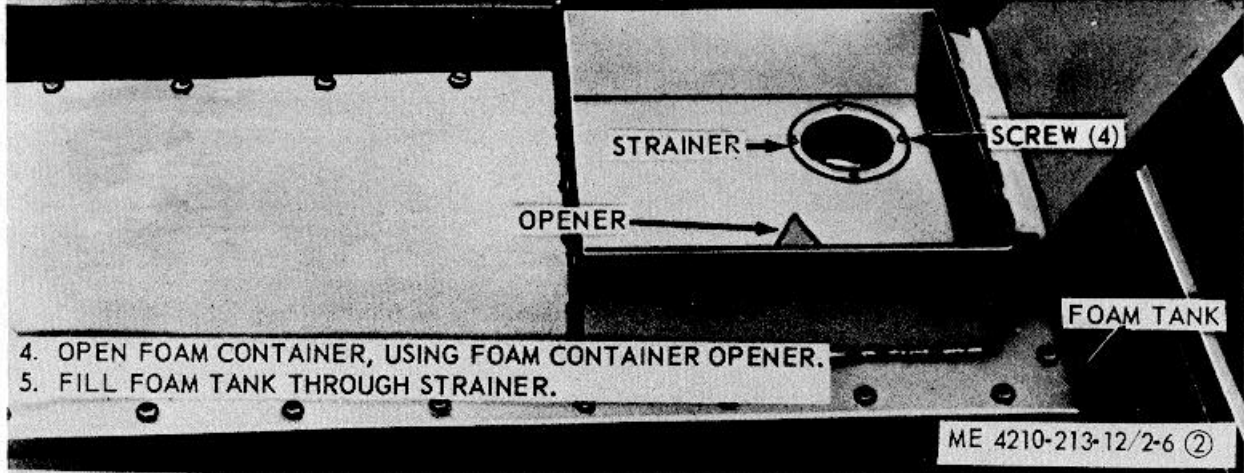

C

Figure 2-6. Continued

1. SET UP TO PUMP IN ANY OF THE THREE METHODS MENTIONED (DRAFT, HYDRANT OR BOOSTER TANK.)
2. OPEN DISCHARGES THROUGH WHICH FOAM HAD BEEN PUMPED.
3. OPEN FOAM FLUSH-OUT V' LVE. (CONTROL LOCATED ON L.H. PUMP PANEL)
4. CONTINUE TO DISCHARGE WATER UNTIL FOAM HAS BEEN COMPLETELY FLUSHED FROM SYSTEM.

NOTE: METERING VALVE MUST BE OPEN TO ALLOW FLUSHING OF SYSTEM.

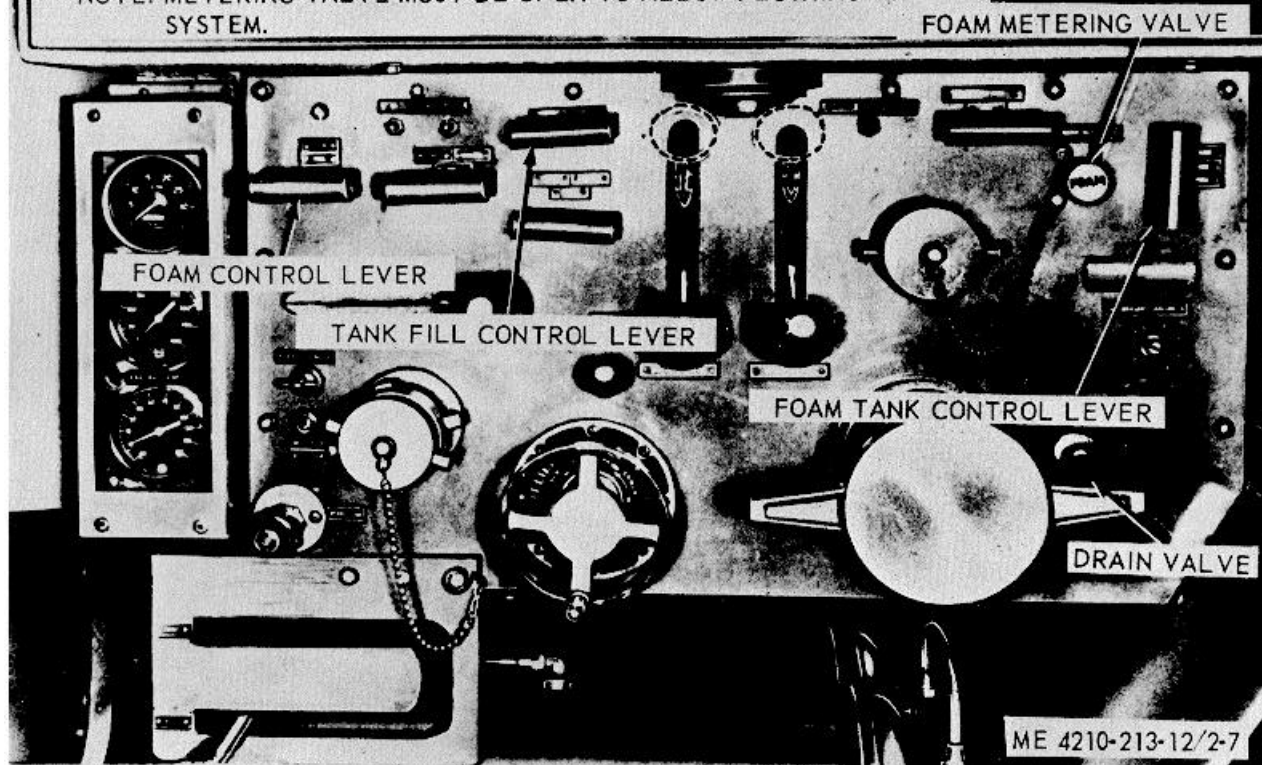
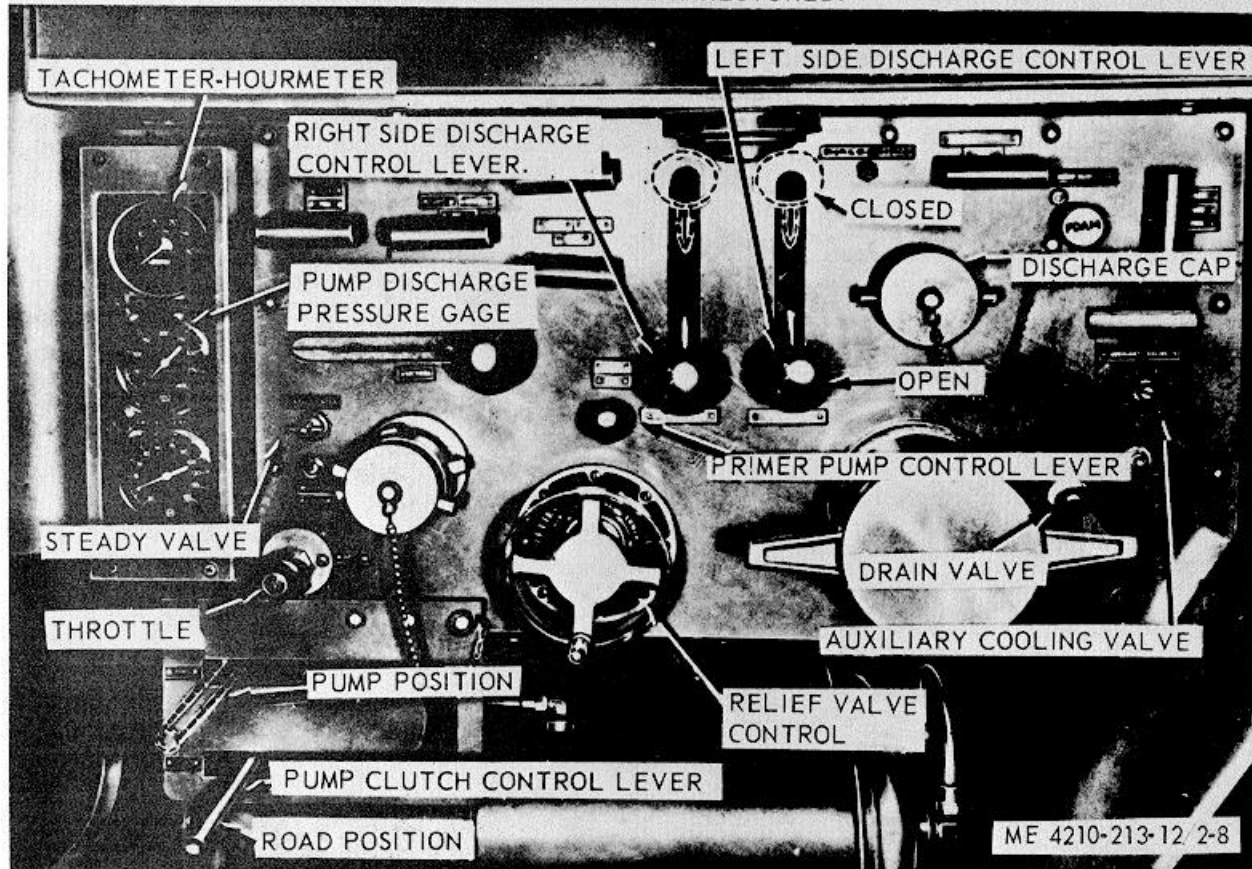

Figure 2-7. Foam system flushing.

1. WATER MAY BE PUMPED EITHER INDEPENDENTLY TO ONE, OR TO ALL OF THE OUTLETS AFTER REMOVING THE DISCHARGE CAPS AND CONNECTING HOSES.
2. GET AS CLOSE TO WATER AS POSSIBLE.
3. PRIME THE WATER PUMP FROM SUCTION LIFT (FIG. 2-8)
NOTE: MAKE SURE RELIEF VALVE WHEEL IS SCREWED OUT TO LESS THAN 100 PSI.
4. MOVE PUMP CLUTCH CONTROL LEVER FROM ROAD TO PUMP POSITION AND OPEN DISCHARGE VALVE OR VALVES.
5. OPEN THROTTLE GRADUALLY UNTIL DESIRED DISCHARGE PRESSURE IS REACHED AND REGULATE AUXILIARY COOLING VALVE TO COOL ENGINE.
6. SET RELIEF VALVE BY WATCHING PRESSURE GAGE AND SCREW IN WHEEL UNTIL PRESSURE INCREASES AND DESIRED PRESSURE IS RESTORED.



7. IF WATER SHOULD CONTINUE TO FLOW OUT PRIMING PUMP DISCHARGE AFTER MAIN PUMP IS RUNNING, FLUSH PRIMING VALVE BY PULLING AND RELEASING PRIMING PUMP CONTROL LEVER SEVERAL TIMES.
8. IF FOR CHANGING HOSE OR FOR ANY OTHER REASON A SHUT-DOWN IS DESIRED WHEN WORKING FROM LIFT, SIMPLY SLOW DOWN TO ABOUT 20 POUNDS ON ORDINARY LIFTS AND 35 POUNDS ON HIGH LIFTS AND CLOSE DISCHARGE VALVES. TO RESUME SIMPLY OPEN THE DISCHARGE VALVES AND THROTTLE AND RESET RELIEF VALVE.
WARNING USE OF A NOZZLE TOO SMALL FOR THE PRESSURE CAN RUPTURE THE HOSE.
WARNING WHEN WATER IS BEING PUMPED THROUGH THE DISCHARGE SYSTEM, AT LEAST TWO MEN SHOULD CONTROL THE HOSE AT THE NOZZLE TO PREVENT THE HOSE FROM WHIPPING AND CAUSING SERIOUS INJURY.

Figure 2-8. Pumping water from suction lift.

1. WATER MAY BE PUMPED EITHER INDEPENDENTLY TO ONE OR TO ALL OF THE OUTLETS AFTER REMOVING THE DISCHARGE CAPS AND CONNECTING HOSES.
2. OPEN HYDRANT TO PRIME PUMP (FIG. 2-2).
3. MOVE PUMP CLUTCH CONTROL LEVER FROM ROAD TO PUMP POSITION, AND OPEN DISCHARGE VALVE OR VALVES.
4. OPEN THROTTLE GRADUALLY UNTIL DESIRED DISCHARGE PRESSURE IS REACHED AND REGULATE AUXILIARY COOLING VALVE TO COOL ENGINE.
5. SET RELIEF VALVE BY WATCHING PRESSURE GAGE AND BACKING OUT WHEEL UNTIL PRESSURE DROPS. THEN SCREW IN UNTIL ORIGINAL PRESSURE IS RESTORED.

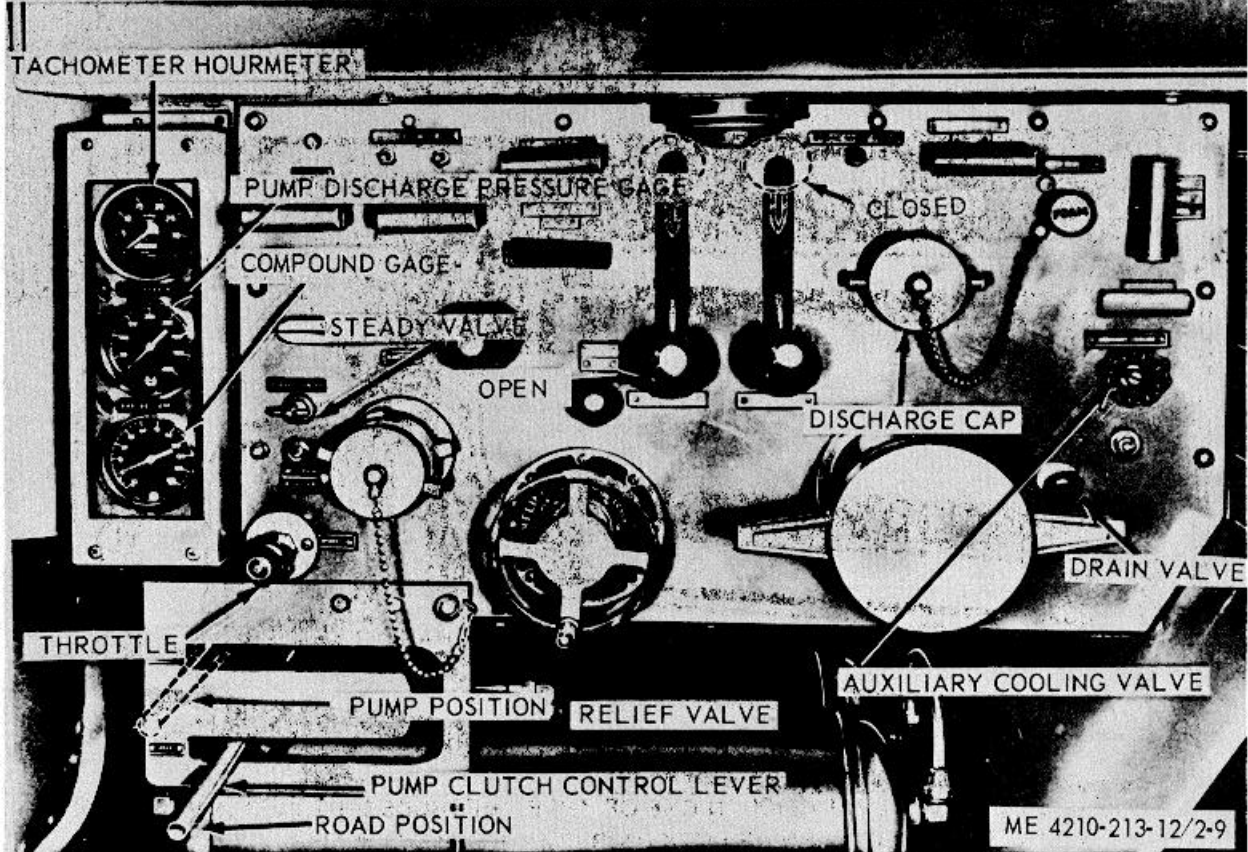

6. WATCH PRESSURE GAUGE AS THROTTLE IS OPENED. IF ENGINE SPEED INCREASES WITHOUT PRESSURE GOING UP, YOU HAVE PASSED THE MOST EFFICIENT POINT OF OPERATION. CLOSE THROTTLE SLOWLY UNTIL THE PRESSURE BEGINS TO DROP AND THE ENGINE SPEED BECOMES REASONABLE.
CAUTION: MAKE SURE THE COMPOUND GAUGE DOES NOT REGISTER BELOW 0 PSI. SERIOUS DAMAGE TO WATER MAINS MAY RESULT.
 7. IF COMPOUND GAUGE SHOWS VACUUM BEFORE DESIRED PRESSURE IS REACHED, THIS IS AN INDICATION THAT PUMP IS DRAWING ALL THE WATER HYDRANT WILL SUPPLY. USE SMALLER TIPS TO OBTAIN MORE PRESSURE.
- NOTE: USE STEADY VALVE TO REMOVE FLUCTUATIONS IN THE PUMP DISCHARGE PRESSURE GAUGE.

Figure 2-9. Pumping water from hydrant.

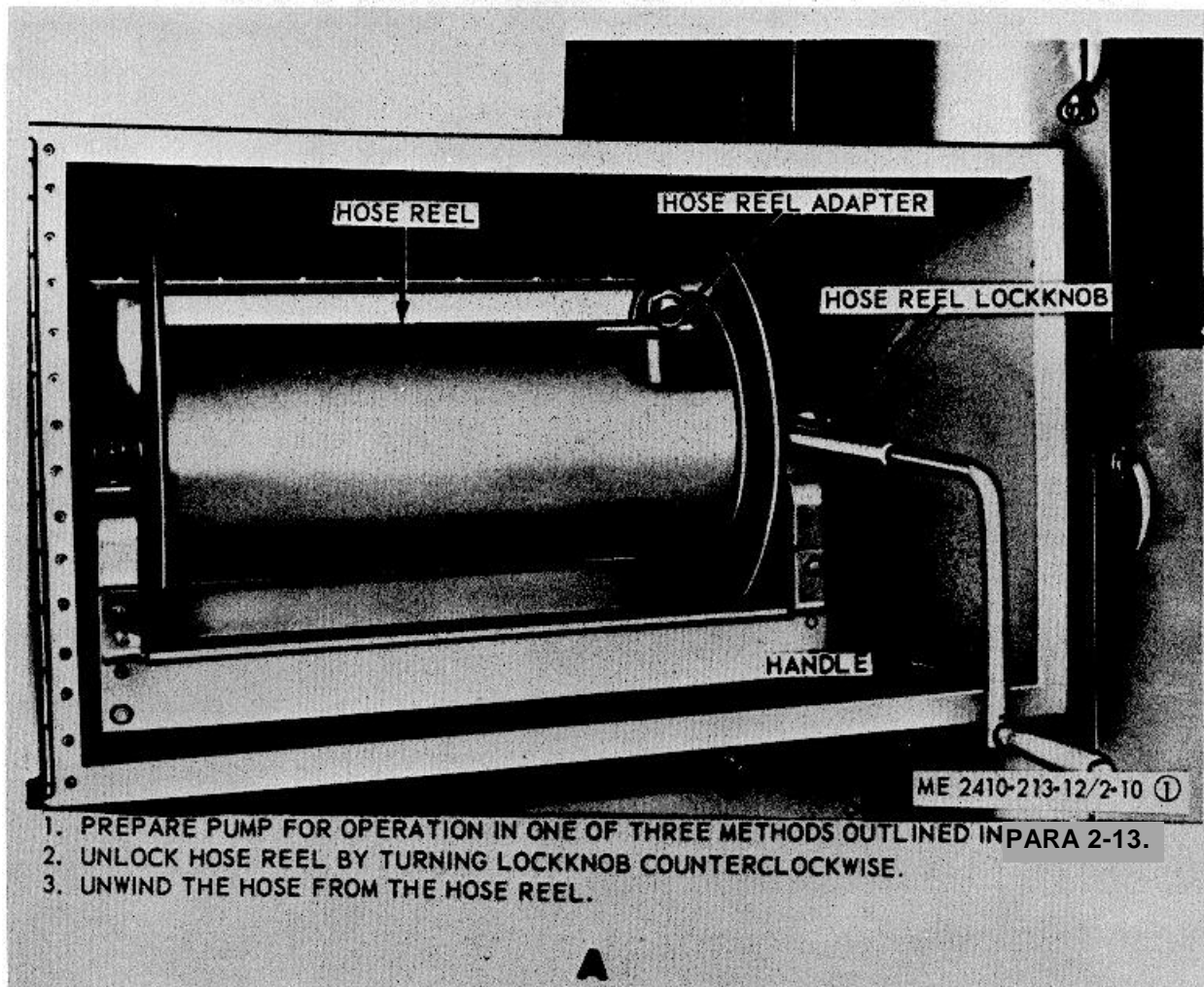
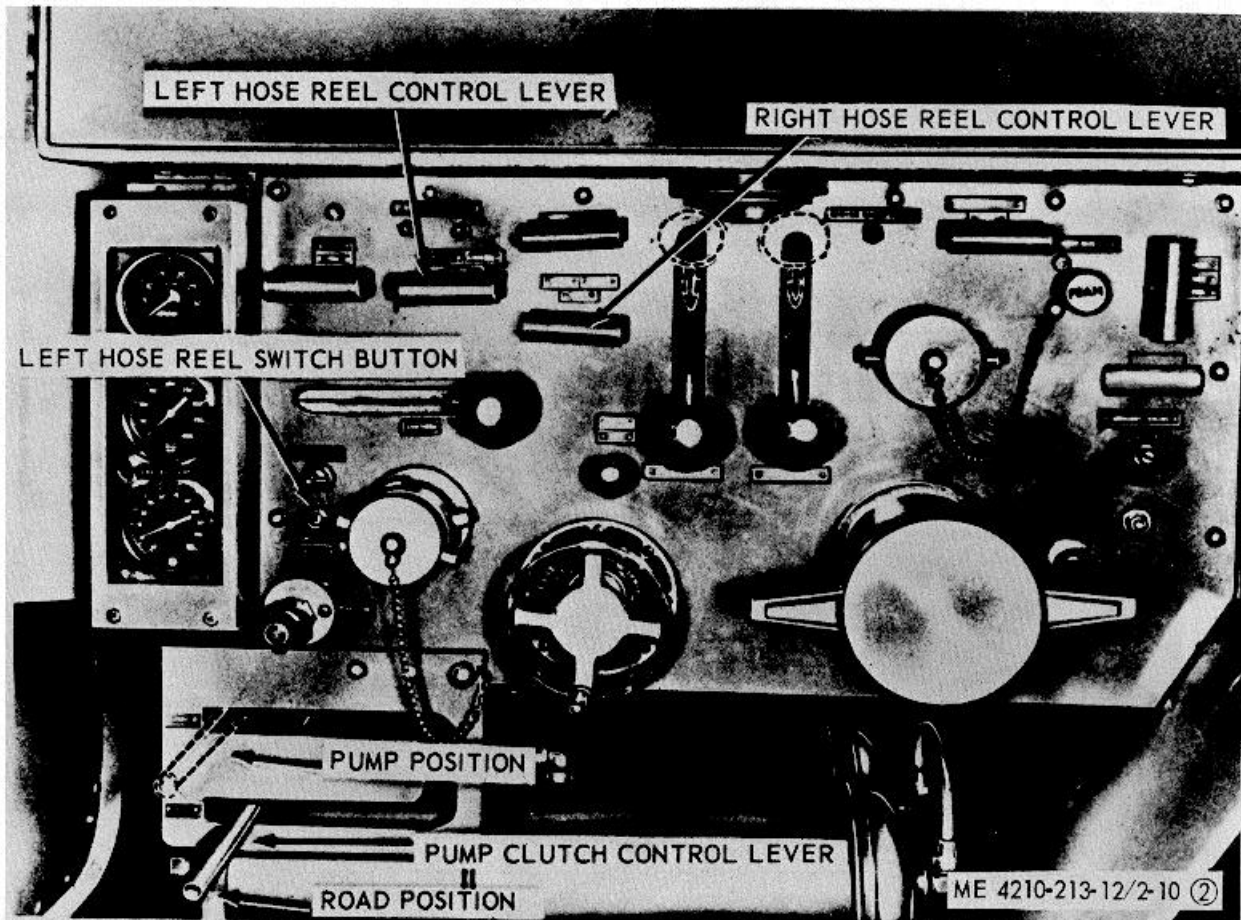

Figure 2-10. Pumping water from the hose reels.



4. MOVE PUMP CLUTCH CONTROL LEVER FROM ROAD TO PUMP POSITION.
 5. OPEN THROTTLE UNTIL DESIRED PRESSURE IS REACHED AND .
REGULATE AUXILIARY COOLING VALVE TO COOL ENGINE.
 6. PULL OUT ON THE LEFT HOSE REEL CONTROL LEVER.
 7. AFTER PUMPING IS COMPLETE DRAIN THE HOSE , AND REWIND ON REEL BY PUSH-
ING LEFT HOSE REEL REWIND SWITCH BUTTON.
- NOTE: PUMP WATER FROM THE RIGHT HOSE REEL IN A SIMILAR MANNER.
NOTE: IN CASE OF FAULTY HOSE REEL MOTOR OR ELECTRICAL SYSTEM,
HOSE REEL CAN BE OPERATED MANUALLY WITH THE HANDCRANK.
8. LOCK HOSE REEL BY TURNING LOCKKNOB CLOCKWISE.

B

Figure 2-10--Continued

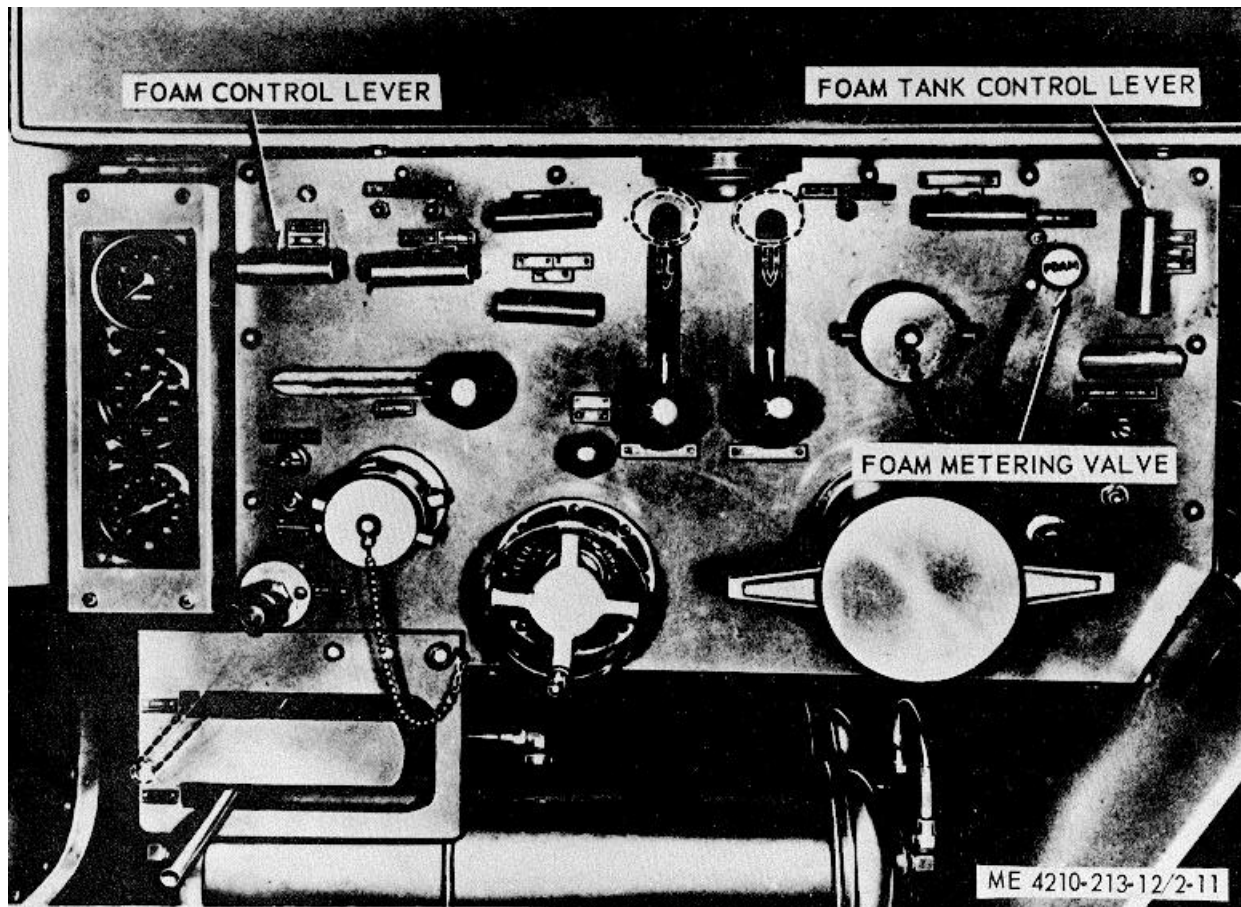

- 1 FILL THE FOAM TANK (FIG. 2-6).
- 2 PRESET THE METERING FOAM VALVE IN ACCORDANCE WITH FOAM METERING PLATE.
- 3 PREPARE THE PUMP FOR OPERATION IN ONE OF THREE METHODS OUTLINED IN (PARA. 2-14)
- 4 OPEN THE FOAM TANK CONTROL LEVER.
- 5 OPEN THE FOAM CONTROL LEVER.
- 6 PUMP WATER AND FOAM FROM THE PUMP DISCHARGE LINE.
- 7 AFTER USE DRAIN AND FLUSH THE SYSTEM (FIG. 2-12).

Figure 2-11. Pumping Foam.

DRAINING AND FLUSHING FOAM TANK:

1. CLOSE THE FOAM VALVE.
2. OPEN THE FOAM TANK DRAIN VALVE (FIG. 2-6).
3. MANUALLY RUN A SUFFICIENT QUANTITY OF WATER THROUGH THE TANK TO FLUSH THE REMAINING FOAM CONCENTRATE FROM THE TANK. CLOSE FOAM TANK DRAIN VALVE.

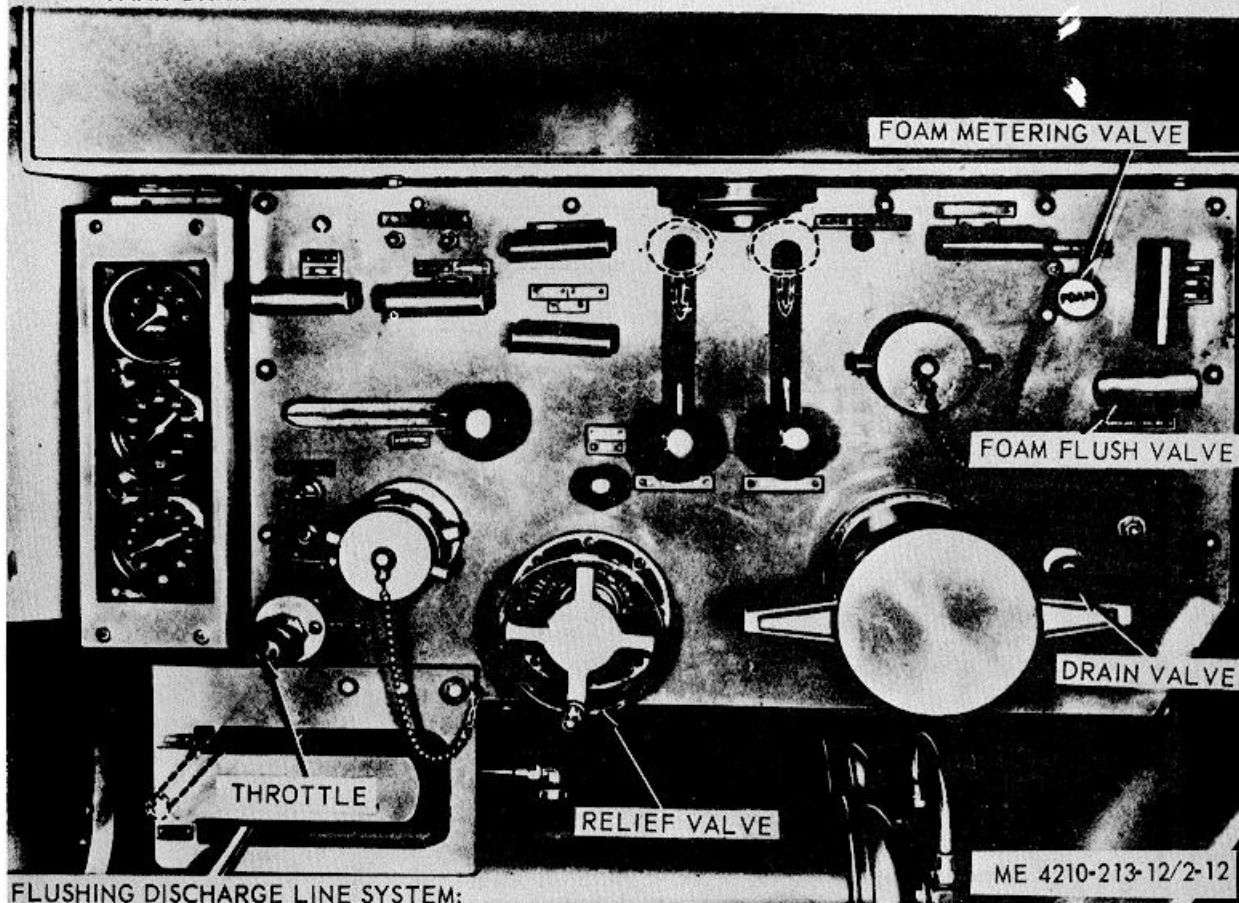

FLUSHING DISCHARGE LINE SYSTEM:

1. START ENGINE(PARA. 2-11) AND REDUCE ENGINE SPEED WITH THROTTLE.
2. REDUCE PRESSURE IN RELIEF VALVE BY TURNING VALVE WHEEL COUNTER-CLOCKWISE.
3. WITH FOAM VALVE CLOSED OPEN FOAM METERING VALVE TO MAXIMUM.
4. OPEN FOAM FLUSH VALVE (KEEP FOAM VALVE CLOSED) AND PUMP WATER AS DESCRIBED IN FIG. 2-11
5. ALLOW WATER TO RUN THROUGH THE SYSTEM UNTIL FOAM IS DEPLETED.
6. SHUT UNIT DOWN.
7. OPEN THE WATER PUMP AND LINES DRAIN VALVE (FIG. 2-2).

NOTE: ALWAYS FLUSH THE FOAM SYSTEM AS SOON AS IT IS DRAINED UNLESS IT IS TO BE IMMEDIATELY REFILLED. IF THE FOAM SYSTEM IS NOT FLUSHED, DAMAGE WILL RESULT AND RENDER THE SYSTEM INOPERATIVE.

Figure 2-12. Draining and flushing foam concentrate tank and discharge line system.

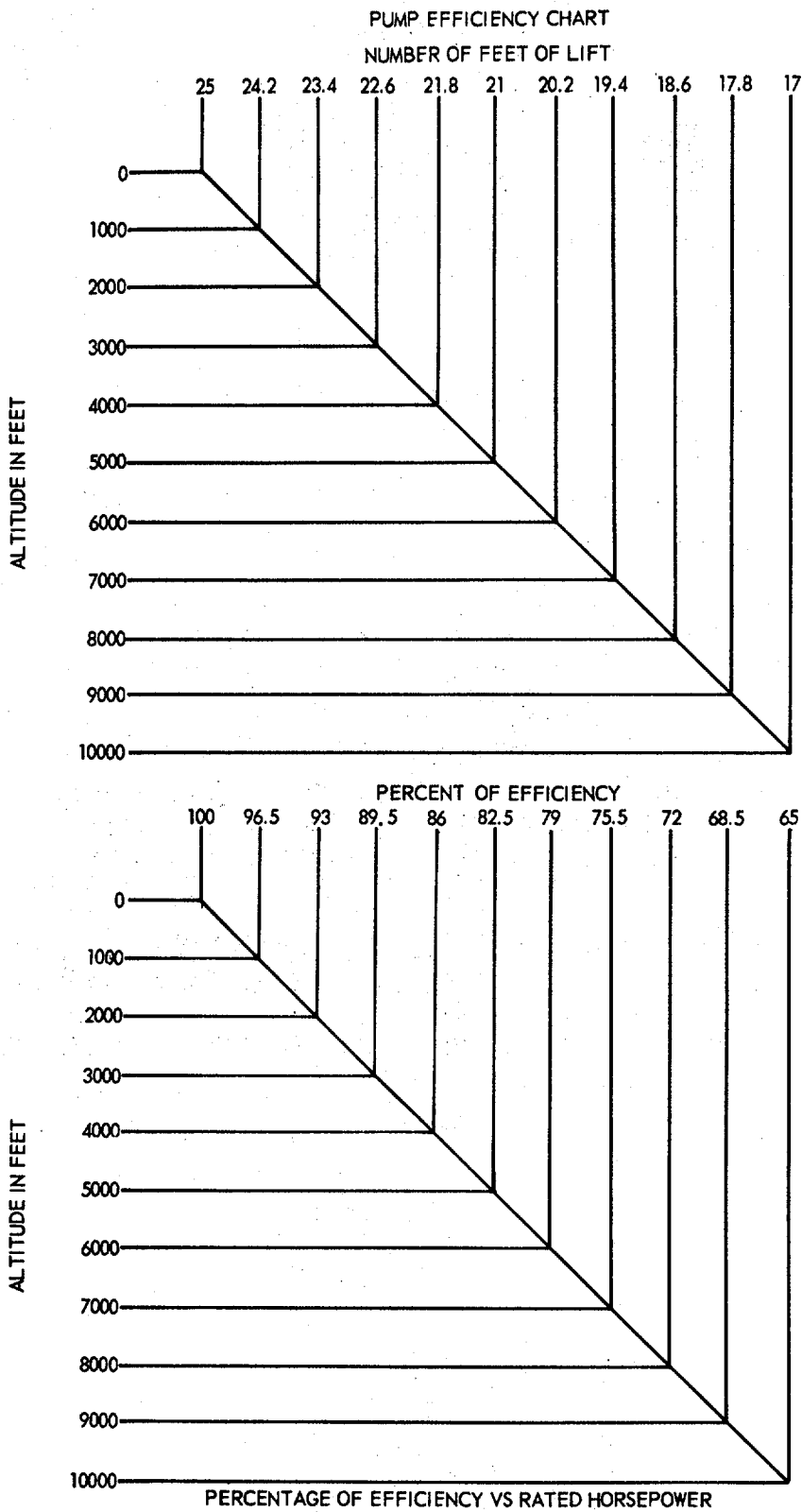

ME 4210-213-12/2-13

Figure 2-13. Pump performance chart.

lines and leave drain open until all water is drained, then close drain.

2-19. Operation in Extreme Heat

a. General. Refer to TM 9-2320-209-10 for additional information on operating the fire truck in extreme heat. Pumps are not affected by extreme heat, except for lubrication requirements.

b. Lubrication- Be sure to use the proper grade lubricant for all points of application. Refer to LO 9-2320-23-12 and LO -421021-12 for special lubrication. Check the lubricant level frequently.

2-20. Operation in Sandy or Dusty Areas

a. Lubrication. Keep all lubrication points clean and well lubricated. Lubricate sparingly but more frequently than under normal conditions. Clean all oily or grease surfaces, paying particular attention to the pump oil fill as it accumulates dust and sand. Service the air cleaners, breathers, and oil filters more frequently than under normal conditions (TM 92320-209-10).

b. Cooling and Fuel Systems. Service the radiator, fuel tank, and fuel filter (TM 92320-209-10).

c. Pumps and Hose Reels. Keep the body compartment doors closed except to perform necessary operations. Wipe the hose reel drive gears and drive chains to remove as much grease and oil from the exposed surfaces as possible. When dusty or sandy conditions no longer exist, remove the chains and wash with an approved cleaning solvent, lubricate and reinstall. Clean all the machine surfaces of the pump and control linkages to remove accumulated dust and sand.

d. Electrical Systems. Keep the insulation electrical connections, and all motors free from dust and sand to prevent wear and short circuits. Cover the siren

when not in use.

2-21. Operation Under Rainy or Humid Conditions

a. General. High humidity causes a rusting and corrosive action to exposed metal surfaces not protected with oil or grease.

b. Fuel System. Keep the fuel tank as full as possible to eliminate condensation. Clean the fuel line sediment bowl daily (TM 9-2320-209-10) .

c. Electrical Systems. Keep the electrical system clean and dry. Wipe off any excess moisture. Pay particular attention to electrical connections.

2-22. Operation in Salt Water

a. General. The deterioration and corrosion of exposed metal is greatly accelerated in salt water areas. Coat all exposed metal surfaces with an approved! lubricant. When the fire truck has been partly immersed or sprayed with salt water, wash down with fresh water.

b. Pumping Salt Water. Do not use salt water except in case of extreme emergency. At the earliest opportunity after pumping salt water, flush the tank piping and fire pump thoroughly with fresh water. After flushing, drain the fire pump.

2-23. Operation at High Altitude

a. General. Operation at high altitude presents special problems due to lower atmospheric pressure and a wide difference in temperature, which occurs during the day and night. Protect the fire truck at all times from the lowest anticipated temperature.

b. Cooling System. Keep the cooling system clean and filled to the proper level. Inspect frequently as water evaporates more rapidly at high altitudes. Keep the radiator clean and engine compartment doors and radiator shutters open when in operation.

Section V. OPERATION OF AUXILIARY MATERIAL USED IN CONJUNCTION WITH FIRE TRUCK

2-24. Fire Extinguishers

a. All Fire Extinguishers on the truck are

Government furnished equipment.

b. Refer to TM 5-687 for maintenance and refilling.

CHAPTER 3
OPERATOR AND ORGANIZATIONAL MAINTENANCE INSTRUCTIONS

**Section I. OPERATOR AND ORGANIZATION MAINTENANCE
TOOLS AND EQUIPMENT**

3-1. Special Tools and Equipment

No special tools or equipment are required by operator or organizational maintenance personnel for maintenance of the fire truck.

3-2. Basic Issue Tools and Equipment

Tools and repair parts issued with or authorized for use with the fire truck are listed in the basic issue items list, appendix B of this manual.

Section II. LUBRICATION

3-3. General Lubrication Information

a. This section contains a reproduction of the lubrication order and lubrication instructions which are supplemental to, and are not specifically covered in the lubrication order.

b. The lubrication order, shown on figure 3-1, is an exact reproduction of the approved lubrication order for the fire truck, for the current lubrication order, refer to DA Pamphlet 310-4.

3-4. Detailed Lubrication Information

a. *General.* Store lubricants in covered containers that will protect them from dirt, water, and foreign material. Keep all lubrication equipment clean and

ready for use.

b. *Cleaning.* Clean all points of lubrication with an approved cleaning solvent before lubricating.

c. *Points of Application.* Follow the instructions and apply the lubricants as prescribed. It is recommended that the fire truck and each of the components be lubricated while warm from operation. Over lubrication may cause equipment failure, damage to working parts and erratic operation.

d. *Operation after lubrication.* Operate the fire truck engine for five minutes after changing oil and lubricating.

Section III. PREVENTATIVE MAINTENANCE SERVICES

3-5. General

To insure that the fire truck is ready for operation at all times, it must be inspected systematically, so that defects may be discovered and corrected before they result in serious damage or failure. The necessary preventative maintenance services to be performed are listed and described in paragraphs 3-6 and 3-7. The item numbers indicate the sequence of minimum inspection requirements. Defects discovered during operation of the unit will be noted for future correction, to be made as soon as operation has ceased. Step

operation immediately if a deficiency is noted during operation which would damage the fire truck if operation were continued. All deficiencies and shortcomings will be recorded, together with the corrective action taken, on DA Form 2404 (Equipment Inspection and Maintenance Worksheet) at the earliest possible opportunity.

3-6. Daily Preventive Maintenance Services

This paragraph contains an illustrated tabu-

**LUBRICATION
ORDER**

LO 5-4210-213-12

JUNE 1, 1967

**TRUCK, FIRE FIGHTING: POWERED PUMPER; FOAM AND WATER
500 G.P.M. CAP.; CENTRIFUGAL PUMP, POWER TAKE OFF
DRIVEN; 400 GAL. WATER TANK, 40 GAL. FOAM
CHEMICAL TANK (WARD LAFRANCE
MODEL M45A2 WLF)**

Reference: TM5-4210-213-12, LO 9-2320-209-12, C9100 SL

Intervals are based on normal hours of operation. Reduce to compensate for abnormal operations and severe conditions. During inactive periods sufficient lubrication must be performed for adequate preservation.

Clean parts with SOLVENT, dry-cleaning, or with OIL, fuel, Diesel. Dry before lubricating.

Relubricate after washing.

Clean fittings before lubricating.

Drain gear cases when hot. fill and check level.

A dotted circle indicates a drain below.

Lubricate points indicated by dotted arrow shafts on both sides of equipment.

FOLD

FOLD

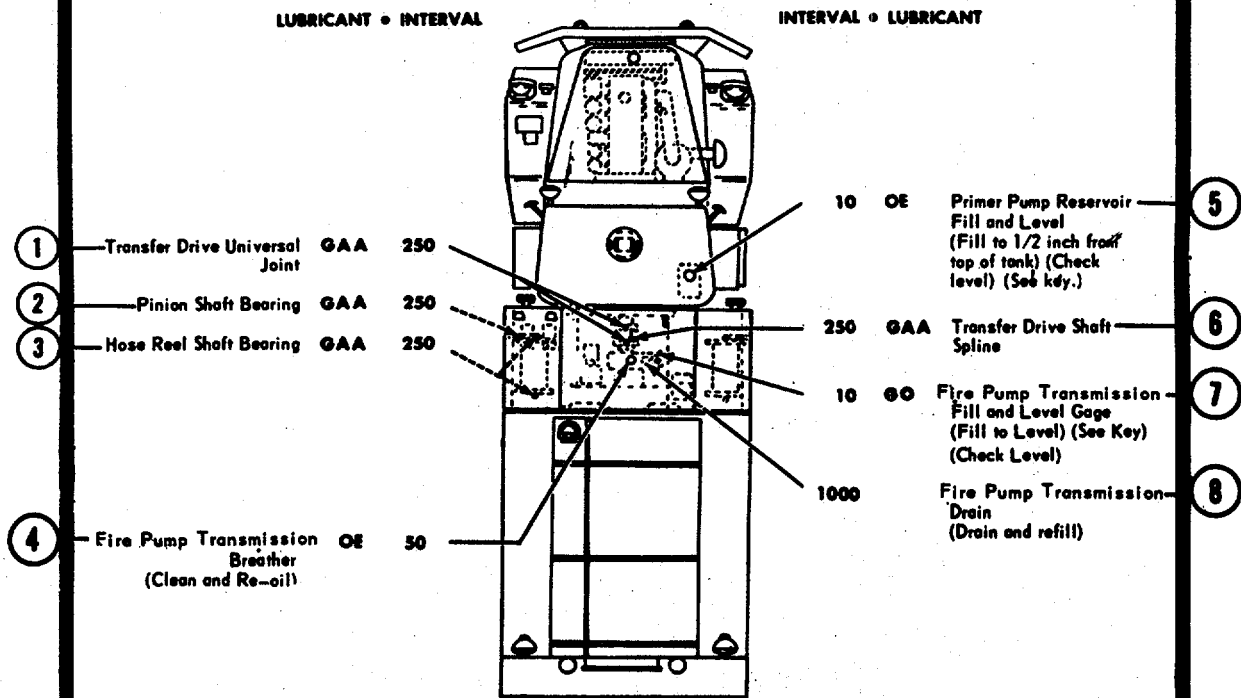

ME 4210-213-12/3-1 ①

Figure 3-1. Lubrication order.

- KEY -

LUBRICANTS	CAPACITY	EXPECTED TEMPERATURES			INTERVALS
		Above +32°F	+40°F to -10°F	0°F to -65°F	
OE-OIL, Engine, Heavy Duty					Intervals given are in hours of normal operation
Primer Pump Reservoir	6 qt.	OE 30 or 9250	OE 10 or 9110	OES	
Oil Can Points					
OES-OIL, Engine, Sub-zero					
GO -LUBRICATING OIL, Gear					
Fire Pump Transmission	2 qt.	GO 90	GO 90	GOS	
GOS-LUBRICATING OIL, Gear, Subzero					
GAA-GREASE, Automotive and Artillery		ALL TEMPERATURES			

1. FOR OPERATION OF EQUIPMENT IN PROTRACTED COLD TEMPERATURES BELOW -10°F. Remove lubricants prescribed in the key for temperatures above -10°F. Clean parts with SOLVENT, dry-cleaning. Relubricate with lubricants specified in the key for temperatures below -10°F.

Copy of this Lubrication Order will remain with the equipment at all times; instructions contained herein are mandatory.

By Order of the Secretary of the Army:

HAROLD K. JOHNSON,
General, United States Army,
Chief of Staff.

2. OIL CAN POINTS. Every 50 hours clean and lightly coat door hinges, latches, throttle and clutch controls with OE.

Official:
J. C. LAMBERT,
Major General, United States Army,
The Adjutant General.

FOLD

FOLD

1. PUMP PACKING SHOULD BE ADJUSTED SO THAT APPROXIMATELY 5 TO 10 DROPS OF WATER PER MINUTE IS ALLOWED TO PASS THROUGH. THIS IS NECESSARY FOR PROPER PACKING LUBRICATION.
2. INSTRUCTION FOR INSTALLING PACKING, ALIGNING LANTERN RING, ZINC SPALENS ETC. SHOULD BE INCORPERATED.
3. CAUTION: "RUBBER "O" RINGS ARE NOT TO BE USED IN RELIEF VALVE. USE "O" RINGS AS SPECIFIED IN TM.

ME 4210-213-12/3-1 ②

Figure 3-1--Continued.

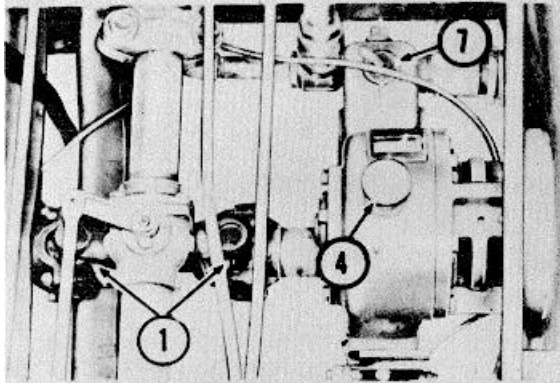

REF. 1 TRANSFER DRIVE UNIVERSAL JOINT
 REF. 4 FIRE PUMP TRANSMISSION BREATHER
 REF. 7 FIRE PUMP TRANSMISSION FILL AND LEVEL GAGE

REF. 4 THE AIR VENT IN THE PRIMING TANK TUBE IS TO BREAK THE SYPHON, THUS PREVENTING OIL FLOW FROM THE TANK INTO THE PRIMING PUMP WHEN THE PRIMING PUMP IS NOT IN OPERATION. THIS HOLE IS MADE WITH A NUMBER 60 (.040) DRILL AND SHOULD NOT BE ENLARGED. THE HOLE SHOULD BE KEPT OPEN AT ALL TIMES. THE AIR VENT IN THE TANK FILLER CAP SHOULD ALSO BE OPEN AT ALL TIMES.

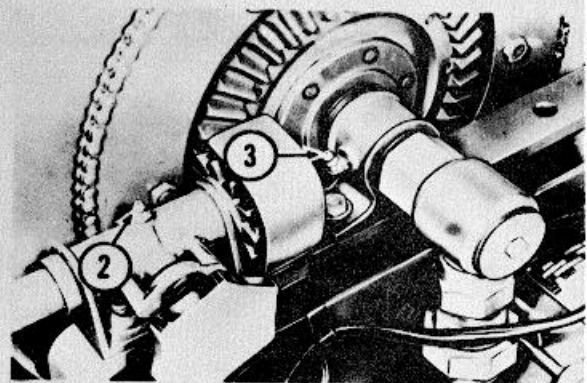

REF. 2 PINION SHAFT BEARING
 REF. 3 HOSE REEL SHAFT BEARING

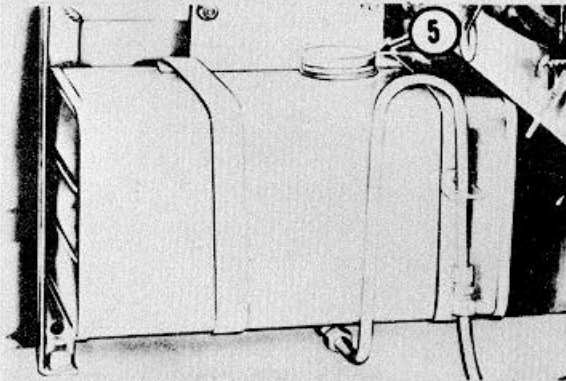

REF. 5 PRIMER PUMP RESERVOIR FILL AND LEVEL

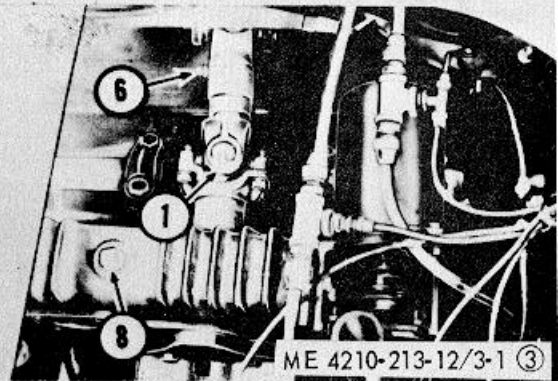

REF. 1 TRANSFER DRIVE UNIVERSAL JOINT
 REF. 6 TRANSFER DRIVE SHAFT SPLINE
 REF. 8 FIRE PUMP TRANSMISSION DRAIN

Figure 3-1--Continued.

PREVENTIVE MAINTENANCE SERVICES DAILY

TM 5-4210-213-12

TRUCK, FIRE FIGHTING

WARD LAFRANCE MODEL M45A2WLF

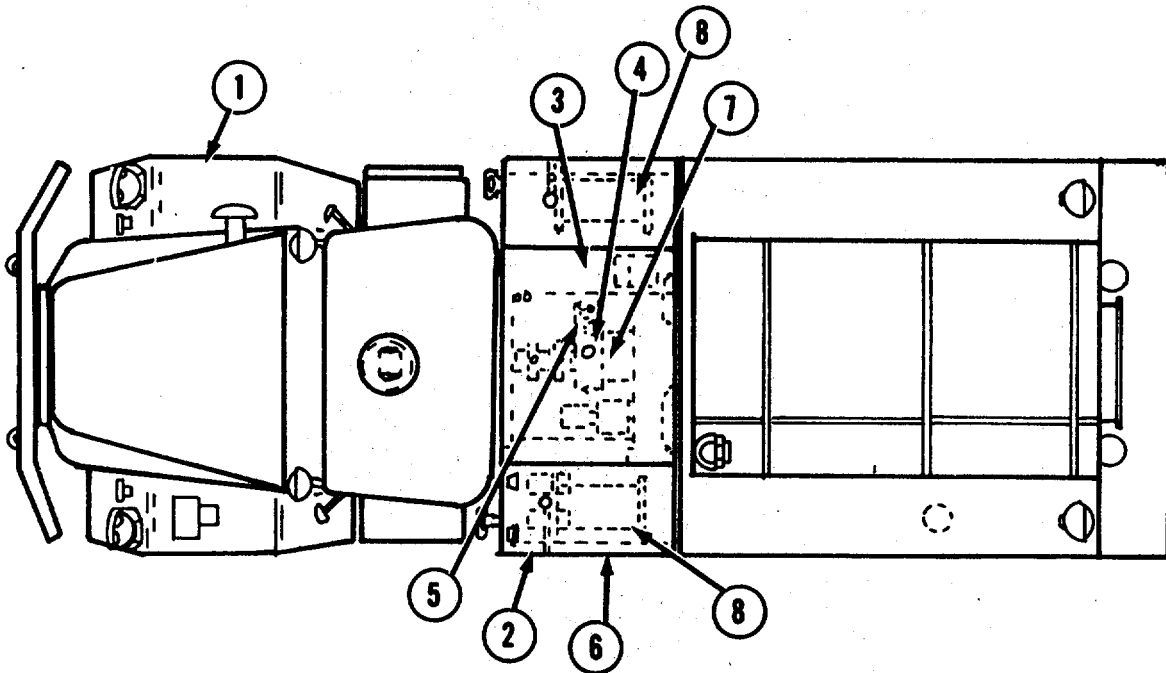

LUBRICATE IN ACCORDANCE WITH CURRENT LUBRICATION ORDER

ITEM		PAR. REF
1	MODEL M45A2 TRUCK CHASSIS. Perform all daily preventative maintenance services listed in table 12 TM 9-2320-209-10.	
2	PUMPING STATION INSTRUMENTS. Normal readings are tachometer - 1550 to 1980 rpm, Oil pressure lamp - out with engine running. Pump discharge pressure - 120 to 250 psi, Engine temperature lamp - out with engine running.	
3	FOAM CONCENTRATE TANK. Check foam concentrate level. Fill to capacity. Flush foam system when drained unless refilling immediately.	Fig. 2-12

ME 4210-213-12/3-2 ①

Figure 3-2. Daily preventative maintenance services.

ITEM		PAR. REF.
4	FIRE PUMP. Check proper operation pressure and controls.	Par. 3-86
5	PRIMING PUMP. Check operation and clear pump.	Par. 3-87
6	DISCHARGE AND SUCTION VALVES. Check proper operation.	Par. 3-90
7	PUMP CLUTCH LINKAGE. Check for proper operation.	Par. 3-91
8.	HOSE REELS. Inspect for operation and loose mountings.	Par. 3-88

ME 4210-213-12/3-2 ②

Figure 3-2--Continued

PREVENTIVE MAINTENANCE SERVICES QUARTERLY

TM 5-4210-213-12.

TRUCK, FIRE FIGHTING

WARD LAFRANCE MODEL M45A2WLF

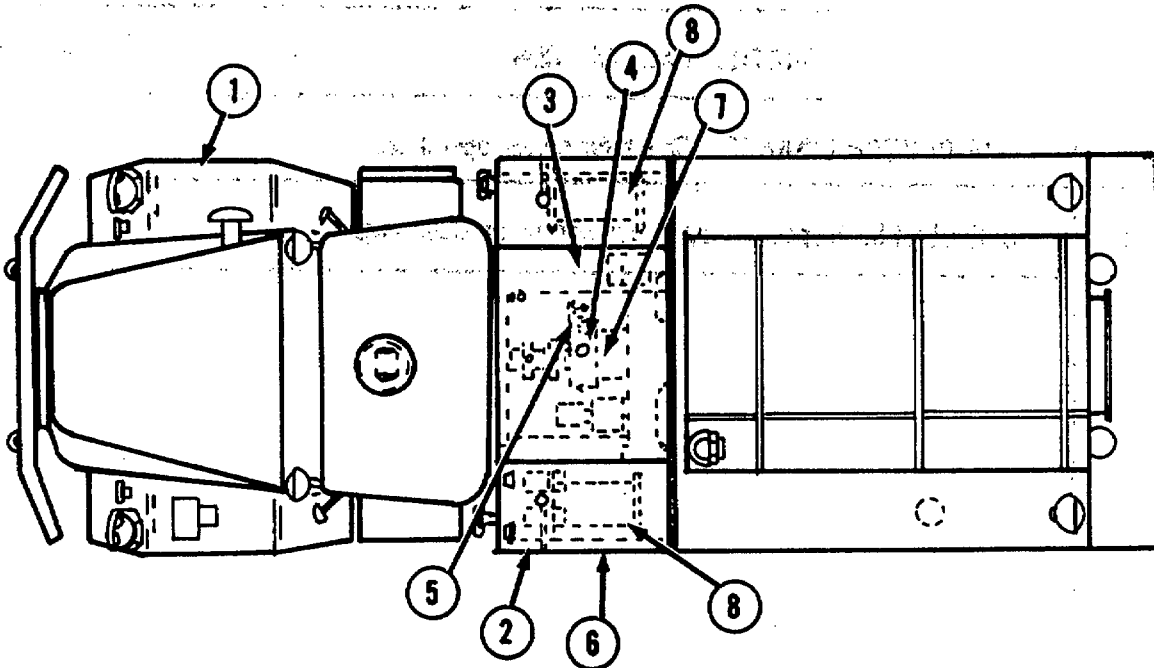

LUBRICATE IN ACCORDANCE WITH CURRENT LUBRICATION ORDER

ITEM		PAR. REF
1	MODEL M45A2 TRUCK CHASSIS. Perform all quarterly preventative maintenance services listed in Table 3, TM9-2320-209-20.	
2	PUMPING STATION CONTROLS AND INSTRUMENTS. Inspect for loose mounting, connections and proper operation. Normal readings are: Tachometer -1550 to 1980 rpm, Oil pressure lamp - out with engine running, Pump discharge pressure -120 to 250 psi, Engine temperature lamp - out with engine running.	
3	FOAM CONCENTRATE SYSTEM. Check foam tank strainer, eductor and vent hose for clogging or damage. If clogged or damaged, clean and replace as required. Check all valve packings.	(Fig. 2-12) (Par. 3-93)

ME 4210-213-12/3-3 ①

Figure 3-3. Quarterly preventative maintenance services.

ITEM		PAR. REF
4	FIRE PUMP. Operate pump and check fire pump packing for proper adjustment. Check for proper discharge pressures and control operation.	Par. 3-98 Par. 2-14, 2-16
5	PRIMING PUMP. Check oil level. Check operation and clear pump.	Par. 3-3 Par. 3-37
6	DISCHARGE AND SUCTION VALVES. Check for proper operation. Check all packings for leaks. Clean cover strainers as required.	Par. 3-90
7	PUMP CLUTCH LINKAGE. Check clutch for proper operation and adjustment. Adjustment should be 1/8 inch clearance between clutch lever and arm.	Par. 3-91
8	HOSE REELS. Inspect for loose mounting and proper operation. Unreel the hoses and inspect for cuts, fraying and deterioration. Inspect drive chain for proper adjustment. Chain deflection should be 1/8 inch between drives.	Par. 3-88 Par. 3-89
	NOTE: OPERATIONAL TEST. During operation check for unusual noise or vibration and proper operation. Also check all packings, piping and gaskets for leaks.	

ME 4210-213-12/3-3 ②

Figure 3-3. Continued.

listing of preventive maintenance services which must be performed by the operator. The item numbers are listed consecutively and indicate the sequence of minimum requirements. Refer to figure 3-2 for the daily preventive maintenance services.

3-7. Quarterly Preventive Maintenance Services

a. This paragraph contains all illustrated tabulated listing of preventive maintenance services which must

be performed by organizational maintenance personnel at quarterly intervals. A quarterly interval is equal to three calendar months or 250 hours of operation, whichever comes first.

b. The item numbers are listed consecutively and indicate the sequence of minimum requirements. Refer to figure 3- for quarterly preventive maintenance services.

Section IV. OPERATOR'S MAINTENANCE

3-8. General

Instructions in this section are published for the information and guidance of the operator to maintain the fire truck.

a. Chassis (Government furnished TM 9-2320-209-10).

b. Daily preventive maintenance service (para 3-6).

Section V. TROUBLESHOOTING

3-9. General

This section provides information used in diagnosing and correcting unsatisfactory operation or failure of the fire truck and its components. Each trouble system state is followed by a list of probable causes. Any trouble beyond the scope of organizational maintenance will be reported to direct support maintenance.

3-12. Pump Clutch lever is Hard or Impossible to Engage

<i>Probable cause</i>	<i>Possible remedy</i>
Improper linkage or clutch adjustment.....	Adjust clutch or linkages as necessary. (para 3-90)
Disconnected, worn, or bent linkage.....	Connect, repair or replace faulty parts, (para 3-90)

3-10. Fire Pump Capacity Drops

<i>Probable cause</i>	<i>Possible remedy</i>
Engine RPM too low.....	Adjust throttle, (pare 3-45)
Fire pump loses prime ..	Check for air leaks.
	Submerge suction at deeper supply point.
	Reprime pump.
Fire truck too high to permit pump suction..	Change position of fire truck.

3-13. Fire Pump Vibrates or Becomes Noisy

<i>Probable cause</i>	<i>Possible remedy</i>
Cavitation occurring.....	Check suction pressure, relocate suction strainers when pumping from draft. Reprime the pump.
Pump vapor bound and not fully loaded.....	Temporarily reduce speed or partially close discharge valve.

3-11. Fire Pump Fails to Deliver Water Upon Starting

<i>Probable cause</i>	<i>Possible remedy</i>
Lift required beyond pumps capacity	Draw supply from different source or change position of fire truck.
Water discharge valve closed	Open water discharge valve,
Discharge head required higher pump speed....	Increase engine speed.

3-14. Foam Pump Fails to Deliver Adequate Foam Discharge

<i>Probable cause</i>	<i>Possible remedy</i>
Foam concentrate supply is exhausted.....	Refill foam tank. (pare 2-13)
Foam concentrate tank valve is in closed position	Open valve. (pare 2-13)
Improperly adjusted foam metering valve ..	Adjust foam metering valve. (pare 2-13)

3-15. Foam Does Not Have Proper Characteristics for Effective- Use

<i>Probable cause</i>	<i>Possible remedy</i>
Improperly adjusted foam proportion regulating valve	Adjust foam metering valve. (pare 2-13)
Improper nozzle	Change nozzle.
Foam concentrate liquid - supply is diluted or contaminated	Drain and flush foam system. Fill with concentrate of proper quality. (pare 2-13)

3-16. Hose Reel Assemblies Stick and Bind When Reeling or Unreeling Hose

<i>Probable cause</i>	<i>Possible remedy</i>
Insufficient lubrication of hose reel shaft bearings.....	Lubricate as specified in LO 5-4210-213-12.
Hose reel assemblies damaged or defective.....	Replace hose reel. (pare 3-88)

3-17. Hose Reel Assemblies Inoperative

<i>Probable cause</i>	<i>Possible remedy</i>
Motor solenoid relay defective.....	Replace relay (pare 3-88)

<i>Probable cause</i>	<i>Possible remedy</i>
Hose reel switch defective.....	Replace switch (pare 3-67)
Hose-reel assemblies damaged or defective..	Replace hose reel (pare 3-88)

3-18.: Siren Inoperative

<i>Probable cause</i>	<i>Possible remedy</i>
Wiring defective	Tighten loose connections and replace wiring as necessary (pare -49)
Siren hand switch defective.....	Replace defective hand switch (pare 3-50)
Defective siren	Replace or repair defective siren (pare 3-50)

3-19. Spotlight or Warning lights Inoperative

<i>Probable cause</i>	<i>Possible remedy</i>
Wiring defective	Tighten loose connections and replace wiring as necessary (pare 3-49)
Warning light switch defective.....	Replace defective warning light switch (pare 3-68)
Rear ILO spotlight.....	Replace defective rear ILO spotlight (pare 3-78)
Warning light defective .	Replace or repair defective warning light (pare 3-52)
Spotlight defective	Replace defective spotlight (para 3-51).

Section VI. RADIO-INTERFERENCE SUPPRESSION

3-20. Definitions

a. Interference. The term "interference" as used herein applies to electrical disturbances in the radio frequency range which are generated by the fire truck and which may interfere with the proper operation of radio receivers or other electronic equipment, or enable the enemy to locate the equipment.

b. Interference Suppression. The term "interference suppression" as used herein applies to the methods used to eliminate or effectively reduce radio interference generated by the fire truck.

3-21. General Methods Used to Attain Proper Suppression:

Essentially, suppression is attained by providing a low resistance and high-frequency wires, grounding the frame with bonding straps, and using capacitors and resistors.

3-22. Interference Suppression Components

a. Primary Suppression Components.

(1) Capacitors. The fire truck has four capacitors located on the siren, siren flasher, and warning light. The capacitors are illustrated on figure 3 4.

(2) Ground Strap. The unit has four ground straps, two from chassis to frame and one each located on the frame to hose motor assemblies. The ground straps are illustrated on figure 3-4

b. Secondary - Suppression Components Tooth-type lockwashers are used to assure good metal-to-metal contact where electrical components are mounted.

3-23. Replacement of Suppression Components

Primary Suppression Components. Replace radio interference components with new components that are identical. Capacitors must be

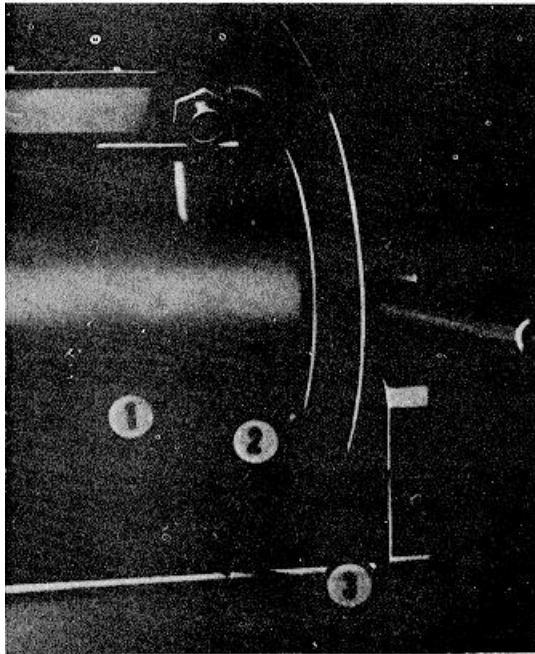

A

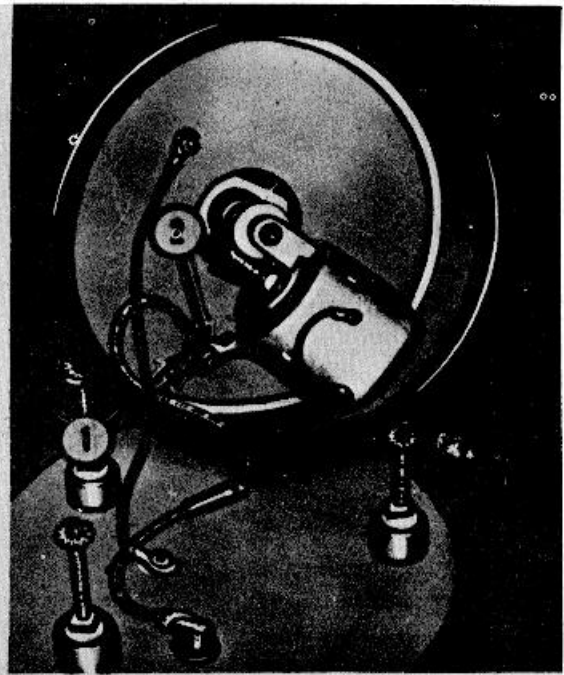

B

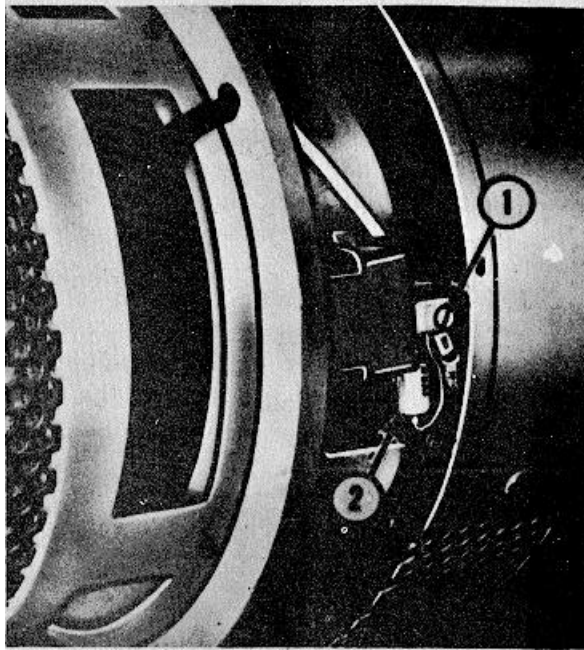

C

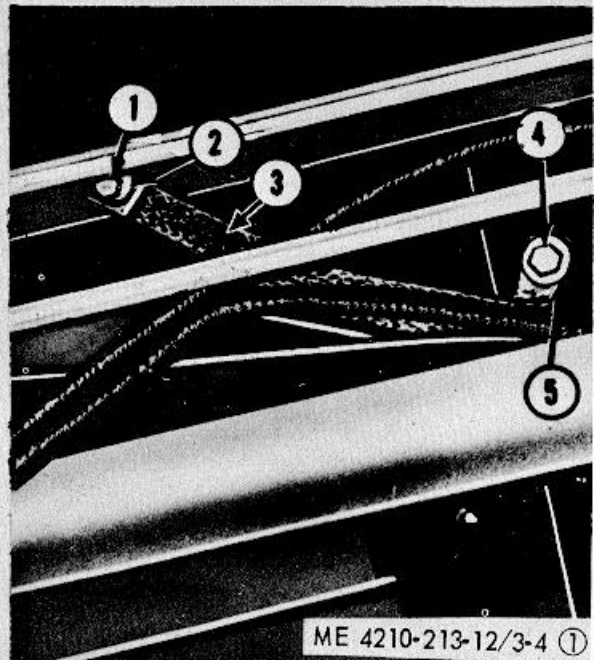

D

Figure 3-4. Radio interferences suppression components.

the same size and have the same rating as the parts being replaced. It is essential that a good metal-to-metal contact is achieved to maintain proper radio interference suppression. To correct faulty suppression, substitute new interference suppression components until faulty components are discovered. Remove the capacitors and ground straps in the numerical sequence as illustrated on figure 3-4.

3-24. Testing of Radio Interference Suppression Components

Test the capacitors for leaks and shorts on a capacitor tester: replace defective capacitors. If test equipment is not available and interference is indicated, isolate the cause of interference by the trial and error method of replacing each capacitor in turn until the cause of interference is located and eliminated.

Section VII. RETAINERS, STEPS, GUARDS, HOSE BED ASSEMBLIES, AND LADDER SUPPORT ASSEMBLIES

3-25. General

The hose retainer, mounted on the right rear of the fire truck provides a means of locking the hoses, inside the hose compartment. A retainer and bracket provides a means for mounting two foam applicator tubes. Two shovel brackets are located on the left rear of the fire truck. The ladder brackets are mounted on the top front of the left side compartments. Two fire extinguisher brackets are mounted on the rear step. Folding Steps are mounted at the front of the hose reel compartments and at the rear of the fire truck. A hand rail is mounted on the rear of the fire truck and splash guards are mounted on each side of the fire truck below the instrument panels. The hose bed partition is located on top of the fire truck water tank and divides the hose compartment into two parts. The hose bed assemblies, which are constructed of wooden slats, lay on top of the water tank. The three ladder support assemblies are attached to the sides and extend above the right and left compartment assemblies.

3-26. Hose Bed Assemblies

a. *Removal.* Refer to figure 3-5 and remove the hose bed assemblies.

b. *Cleaning, Inspection, and Repair.*

(1) Clean all parts in an approved cleaning solvent, and dry thoroughly.

(2) Inspect all parts for damaged or defective condition.

(3) Replace or repair damaged or defective parts as necessary.

c. *Installation.* Refer to figure 3-5 and install the hose bed assemblies on the water tank.

3-27. Hose Bed Partition

a. *Removal.* Refer to figure 3-5 and remove the

hose bed partitions from the water tank.

b. *Cleaning, Inspection and Repair.*

(1) Clean all parts with an approved cleaning solvent, and dry thoroughly.

(2) Inspect all parts for damaged or defective condition.

(3) Replace or repair damaged or defective parts as necessary.

c. *Installation.* Refer to figure 3-5 and install the hose bed partition on the water tank.

3-28. Handrails and Brackets

a. *Removal.* Refer to figure 3-5 and remove the handrails and brackets from the special purpose body.

b. *Cleaning, Inspection, and Repair.*

(1) Clean all parts with an approved cleaning solvent and dry thoroughly.

(2) Inspect all parts for damaged or defective condition.

(3) Replace or repair damaged or defective parts as necessary.

c. *Installation.* Refer to figure 3-5 and install the handrails and brackets on the special purpose body.

3-29. Fire Extinguisher Bracket

a. *Removal.* Refer to figure 3-5 and remove the fire extinguisher bracket from the rear step.

b. *Cleaning, Inspection and Repair.*

(1) Clean all parts with an approved cleaning solvent, and dry thoroughly.

(2) Inspect all parts for damaged or defective condition.

(3) Replace or repair damaged parts as necessary.

c. *Installation.* Refer to figure 3-5 and install the fire extinguisher bracket on the rear step.

3-30. Rear Step

a. Removal.

(1) Remove the fire extinguisher bracket (pare 3-29).

(2) Remove the side handrails and panels (fig. 3-5?).

(3) Refer to figure 3-5 and remove the rear step from the special purpose body.

b. Cleaning, Inspection, and Repair.

(1) Clean all parts with an approved cleaning solvent and dry thoroughly.

(2) Inspect all parts for damaged or defective parts as necessary.

c. Installation.

(1) Refer to figure 3-5 and install the rear step on the special purpose body.

(2) Install the side handrails and panels (fig. 3-5).

(3) Install the fire extinguisher bracket (pare 3-29).

3-31. Shovel Brackets

a. *Removal.* Refer to figure 3-5 and remove the shovel brackets from apron.

b. Cleaning, Inspection, and Repair.

(1) Clean all parts with an approved cleaning solvent, and dry thoroughly.

(2) Inspect all parts for damaged or defective condition.

(3) Replace or repair damaged or defective parts as necessary. :

c. *Installation.* Refer to figure 3-5 and install the shovel bracket on the apron.

3-32. Ladder Support Assemblies

a. *Removal.* Refer to fig. 3 - and remove the ladder support assemblies from the special purpose body.

b. Cleaning, Inspection, and Repair.

(1) Clean all parts with an approved cleaning solvent, and dry thoroughly.

(2) Inspect all parts for damaged or defective condition.

(3) Replace or repair damaged or defective parts.

c. *Installation.* Refer to fig. 3-6 and install

the ladder support assemblies on the special purpose body.

3-33. Foam Nozzle Retainer

a. *Removal.* Refer to fig. 3-6 and remove the foam nozzle retainer from the apron.

b. Cleaning, Inspection, and Repair.

(1) Clean all parts with an approved cleaning solvent, and dry thoroughly.

(2) Inspect all parts for damaged or defective condition.

(3) Replace or repair damaged or defective parts as necessary.

c. *Installation.* Refer to fig. 3-6 and install the foam nozzle retainer on the apron.

3-34. Hose Retainer

a. *Removal.* Refer to figure 3-6 and remove the hose retainer from the apron.

b. Cleaning, Inspection, and Repair.

(1) Clean all parts with an approved cleaning solvent, and dry thoroughly.

(2) Inspect all parts for damaged or defective condition.

(3) Replace or repair damaged or defective parts as necessary.

c. *Installation.* Refer to figure 3-6 and install the hose retainer on the apron.

3-35. Folding Steps

a. *Removal.* Refer to figure 3-6 and remove the folding steps from the special purpose body.

Note

Remove folding steps from pump and hose reel compartment in a similar manner.

b. Cleaning, Inspection, and Repair.

(1) Clean all parts with an approved cleaning solvent, and dry thoroughly.

(2) Inspect all parts for damaged or defective condition.

(3) Replace or repair damaged or defective parts as necessary.

c. *Installation.* Refer to figure 3-6 and install the folding steps on the special purpose body.

3-36. Splash Guards

a. *Removal.* Refer to figure 3-7 and remove the splash guards from the truck chassis.

b. Cleaning, Inspection, and Repair.

(1) Clean all parts with an approved cleaning solvent, and dry thoroughly.

(2) Inspect all parts for damaged or defective condition.

(3) Replace or repair damaged or defective parts as necessary.

c. *Installation.* Refer to figure 3-7, and install the splash guards on the truck chassis.

Section VIII. COMPARTMENT ACCESSORY DOOR, BATTERY BOX, AND OIL PAN HEATER ADAPTER

3-37. General

The compartment accessories are brackets and mounting devices used to secure the fire fighting equipment and accessories such as first aid kits, hose nozzles, axes, and fire extinguishers in the designed compartments along the right and left side of the fire truck. Each compartment is provided with a hinged door. The battery box is located on the right front cab step, and houses two 12 volt batteries. The oil pan heater adapter is mounted under the oil pan.

3-38. Axe, Bars, Cutter, Compartment Accessories Brackets

a. *Removal.* Refer to figure 3-8 and remove the axe, bars, cutters, and compartment accessories brackets from the compartment.

b. *Cleaning, Inspection, and Repair.*

(1) Clean all parts with an approved cleaning solvent, and dry thoroughly.

(2) Inspect all parts for damaged or defective condition.

(3) Replace or repair damaged or defective parts as necessary.

c. *Installation.* Refer to figure 3- and -install the axe, bars, and cutter accessories brackets on the compartment.

3-39. Extinguisher Compartment Accessories

a. *Removal.* Refer to figure 3-9 and remove the extinguisher compartment accessories from the compartment.

b. *Cleaning, Inspection, and Repair.*

(1) Clean all parts with an approved cleaning solvent, and dry thoroughly.

(2) Inspect all parts for damaged or defective condition.

(3) Replace or repair damaged or defective parts as necessary.

c. *Installation.* Refer to figure 3-9 and install the extinguisher compartment accessories on the compartment.

3-40. First Aid Bracket, Hand lantern' Bracket, and Fining Compartment

a. *Removal.* Refer to figure 3 10 and remove the first aid bracket, hand lantern bracket, and fittings from the compartment.

b. *Clearing, Inspection, and Repair.*

(1) Clean all parts with an approved cleaning solvent, and dry thoroughly.

(2) Inspect all parts for damaged or defective condition.

(3) Replace or repair damaged or defective parts as necessary.

c. *Installation.* Refer to figure 3-IO and install the first aid bracket, and fittings on the compartment.

3-41. Pump and Hose Reel Compartment Door Assemblies

a. *Removal.* Refer to figure 3-11 and remove the doors from the compartments as necessary.

b. *Cleaning, Inspection, and Repair.*

(1) Clean all parts with an approved cleaning solvent, and dry thoroughly.

(2) Inspect all parts for damaged or defective condition.

(3) Replace or repair damaged or defective parts as necessary.

c. *Installation.* Refer to figure 3-11 and install the pump and hose reel compartment door assemblies on the compartments as necessary.

3-42. Oil Pan Heater Adapter

a. *Removal.* Refer to figure 3-12 and remove the oil pan heater adapter from the engine oil pan.

b. *Cleaning and Inspection.*

(1) Clean all parts with an approved cleaning solvent, and dry thoroughly.

(2) Inspect all parts for damaged or defective condition.

(3) Replace defective parts as necessary.

c. *Installation.* Refer to figure 3-12 and install the oil pan heater adapter on the engine oil pan.

3-43. Battery Box

a. Removal. Refer to figure 3-13, and remove the battery box from the truck chassis.

b. Disassembly. Refer to figure 3-14 and disassemble the battery box. - -

c. Cleaning, Inspection, and Repair.

(1) Clean all parts with an approved cleaning solvent, and dry thoroughly.

(2) Inspect all parts for damaged or defective condition.

(3) Replace or repair damaged or defective parts.

d. Reassembly. Refer to figure 3-14 and reassemble the battery box in reverse order.

e. Installation. Refer to figure 3-13 and install the battery box on the truck chassis.

Section IX. FUEL SYSTEM

3-44. General

The fuel system consists of a manually operated throttle control that is located on the lower left side area of the left pump operator's control panel. It provides means of changing engine speed other than by the use of controls in the cab.

3-45. Throttle Control and Linkage

a. Removal. Refer to figure 3-15, and remove the throttle control and linkage from the: engine and instrument panel.

b. Cleaning and Inspection.

(1) Clean all parts with a clean cloth dampened in an approved cleaning solvent, and dry thoroughly.

(2) Inspect all parts for damaged or defective condition.

(3) Replace or repair damaged or defective parts as necessary.

c. Installation. Refer to figure 3-15 and install the throttle control and linkage on the engine and instrument panel.

Section X. AIR SYSTEM

3-46. General

This section consists of the various fittings and tubing which connect the air brake system to the air tanks.

3-47. Air Tank Tubing and Fittings

a. Removal. Refer to figure 3-16 and remove the air tank tubing and fittings from the unit.

b. Cleansing, Inspection, and Repair

(1) Clean all parts with an approved cleaning solvent and dry thoroughly.

(2) Inspect all parts for damaged or defective condition.

(3) Replace or repair damaged or defective parts as necessary.

c. Installation. Refer to figure 3-16, and install the air tank tubing and fittings on the unit. -

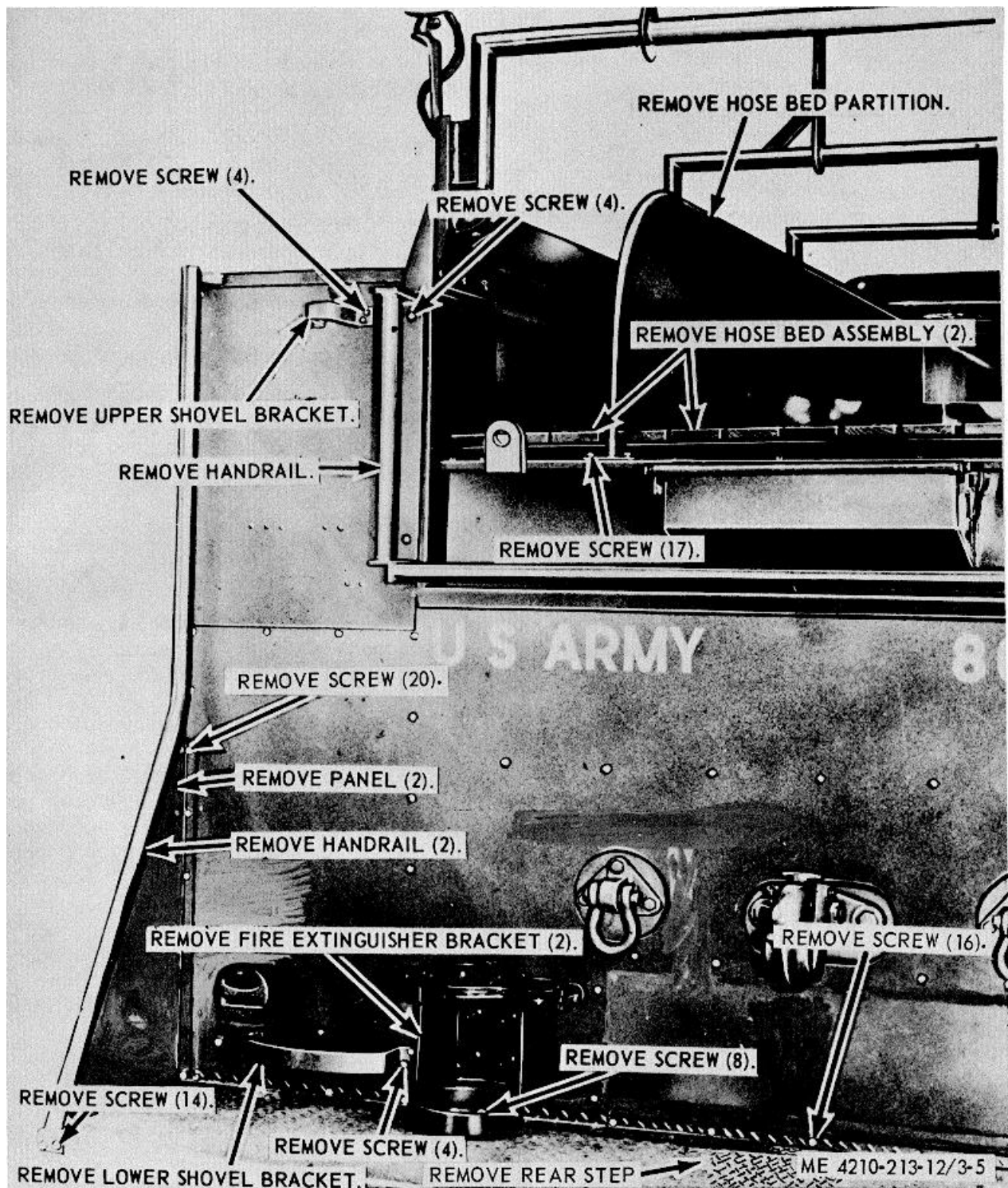

Figure 3-5. Hose bed assemblies, handrails, rear step, tool box door, and brackets, removal and installation.

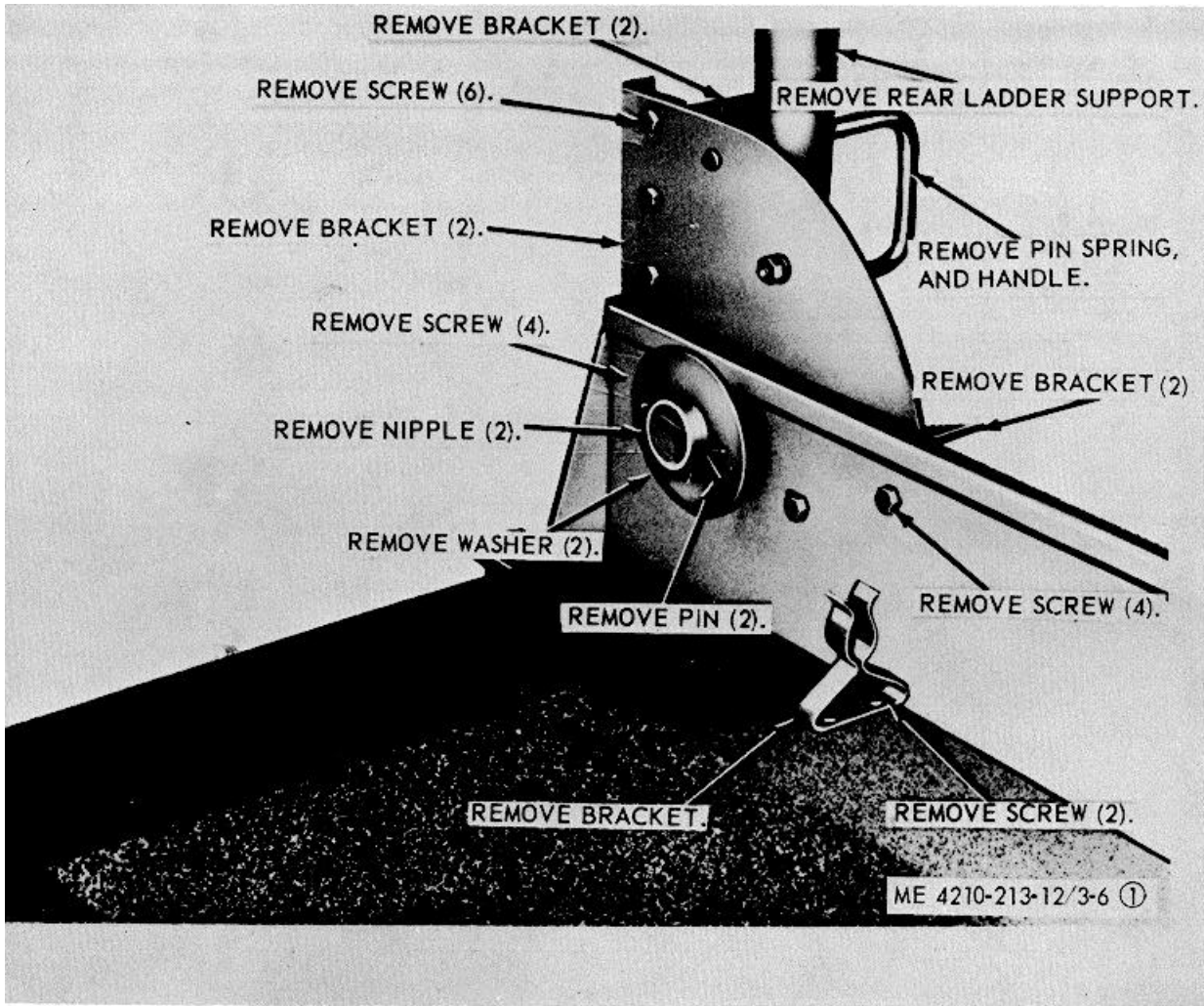

Figure 3-6. Ladder support assemblies, retainers and fill door removal and installation.

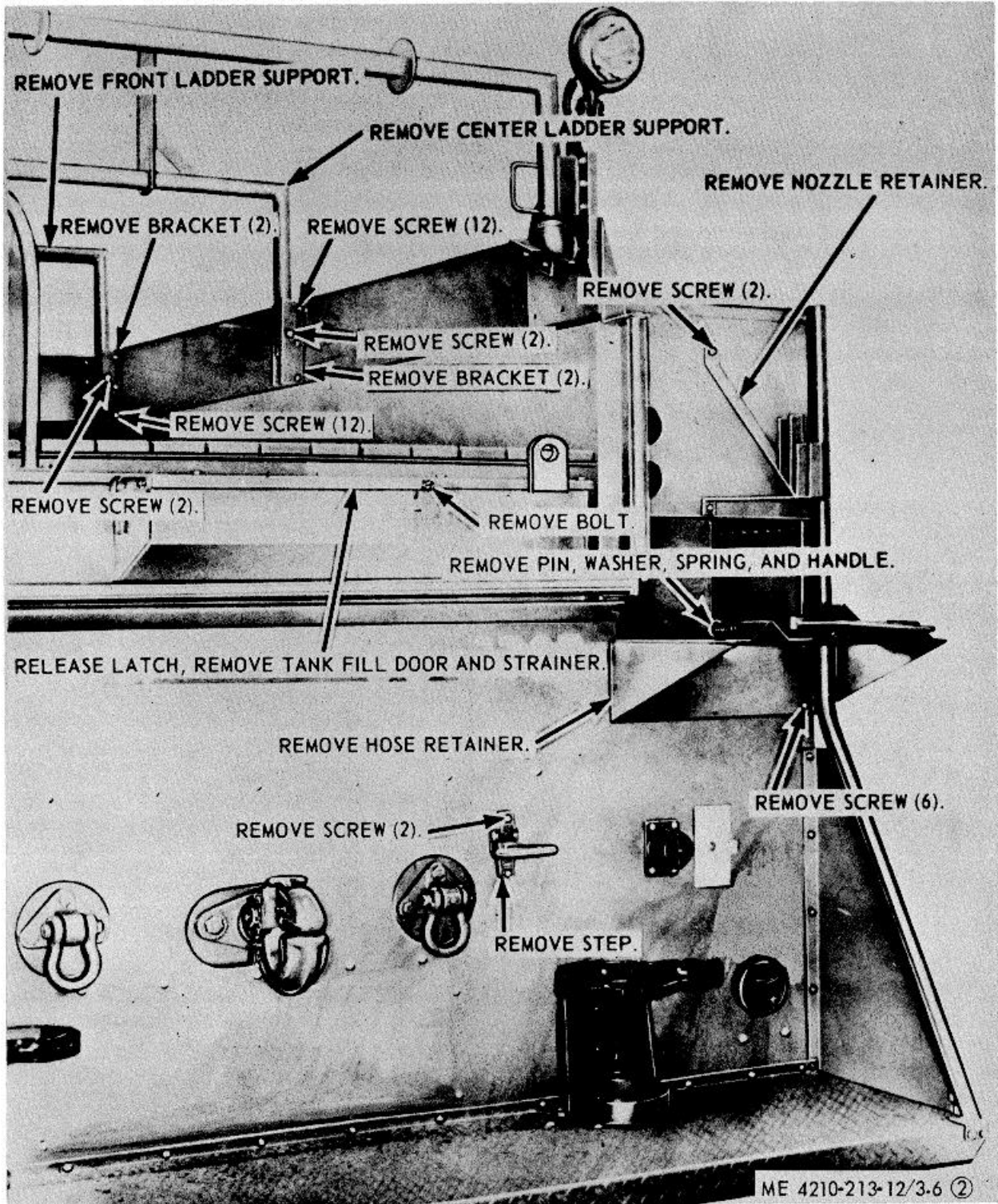

Figure 3-6. Continued

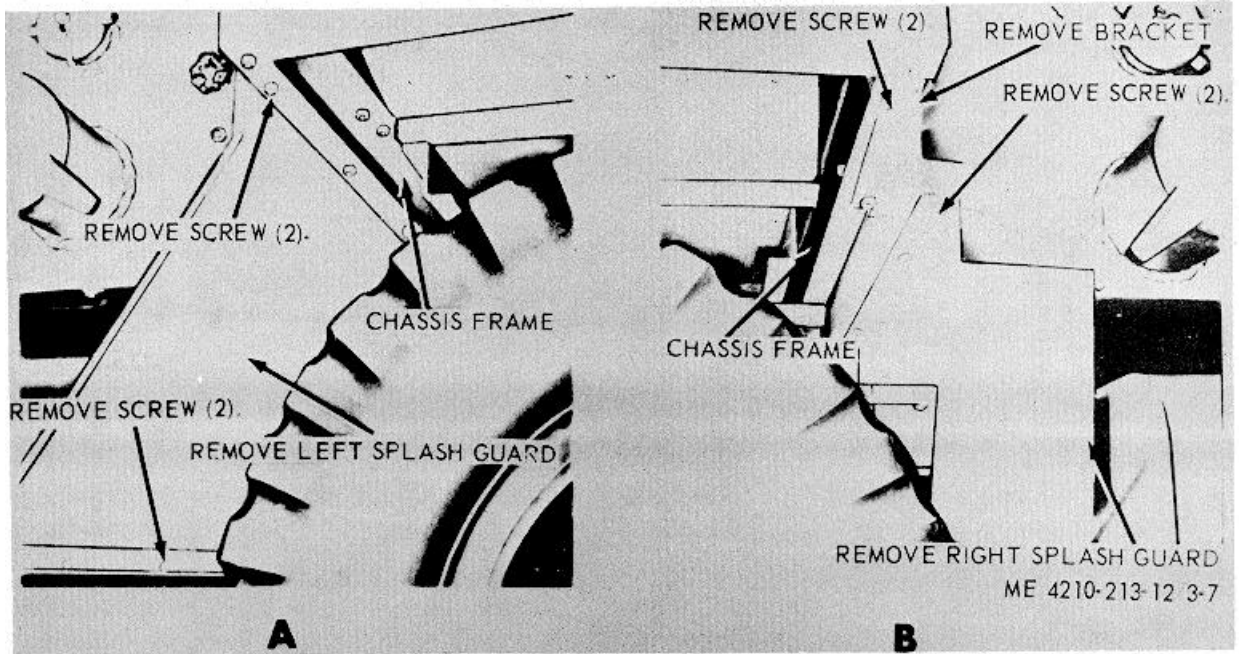

Figure 3-7. Splash gaurds, removal and installation

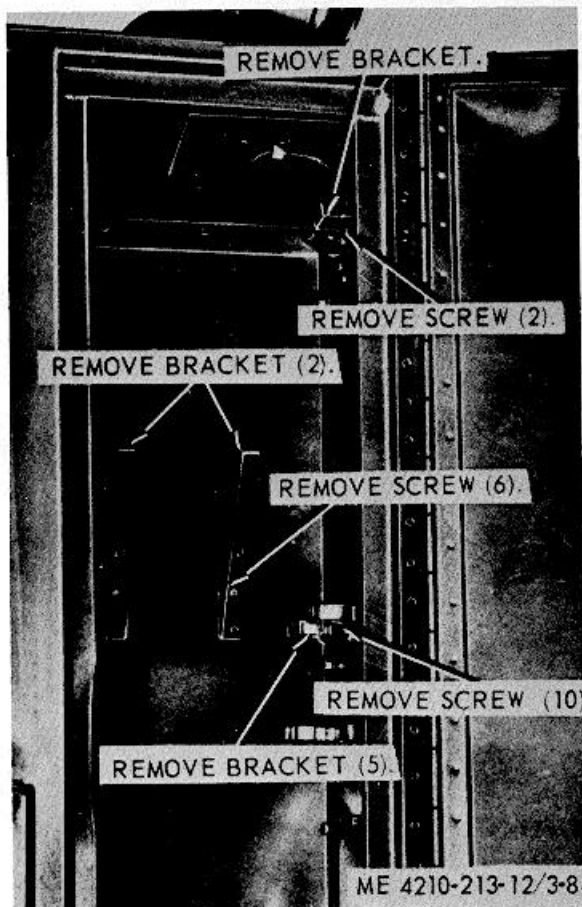

Figure 3-8. Axe, bars, cutter and compartment accessory brackets, removal and installation.

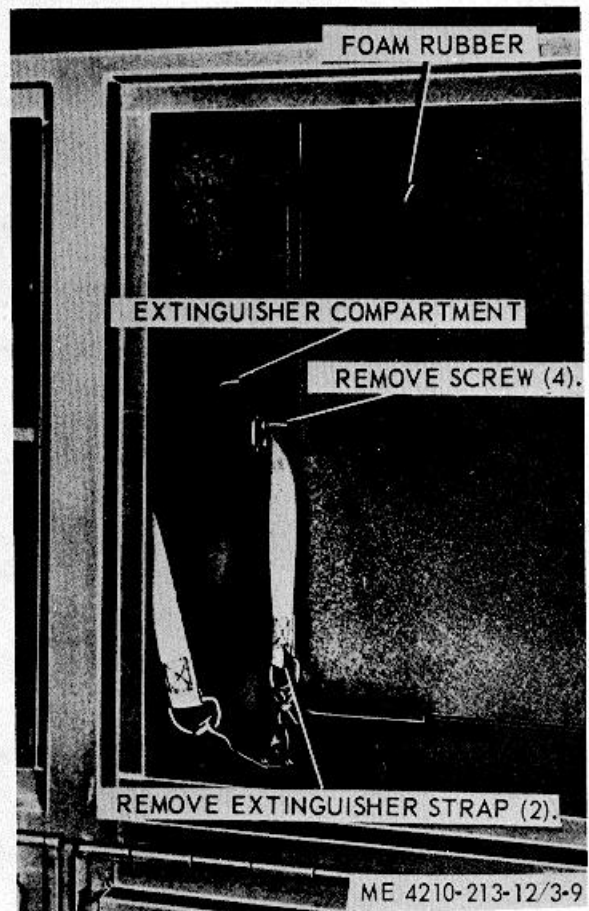

Figure 3-9. Extinguisher compartment accessories, removal and installation.

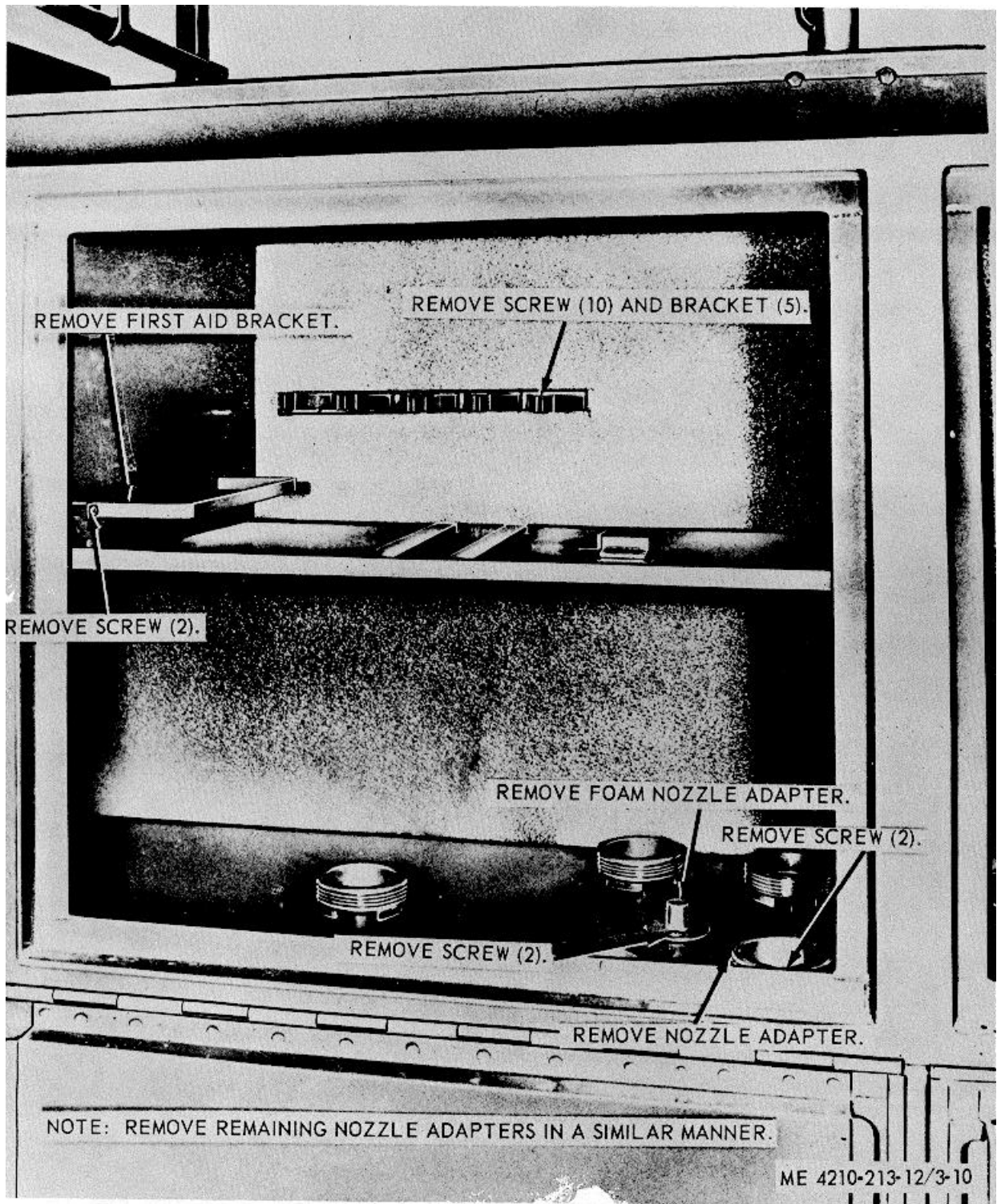

Figure 3-10. First aid bracket, hand lantern bracket fittings, removal and installation.

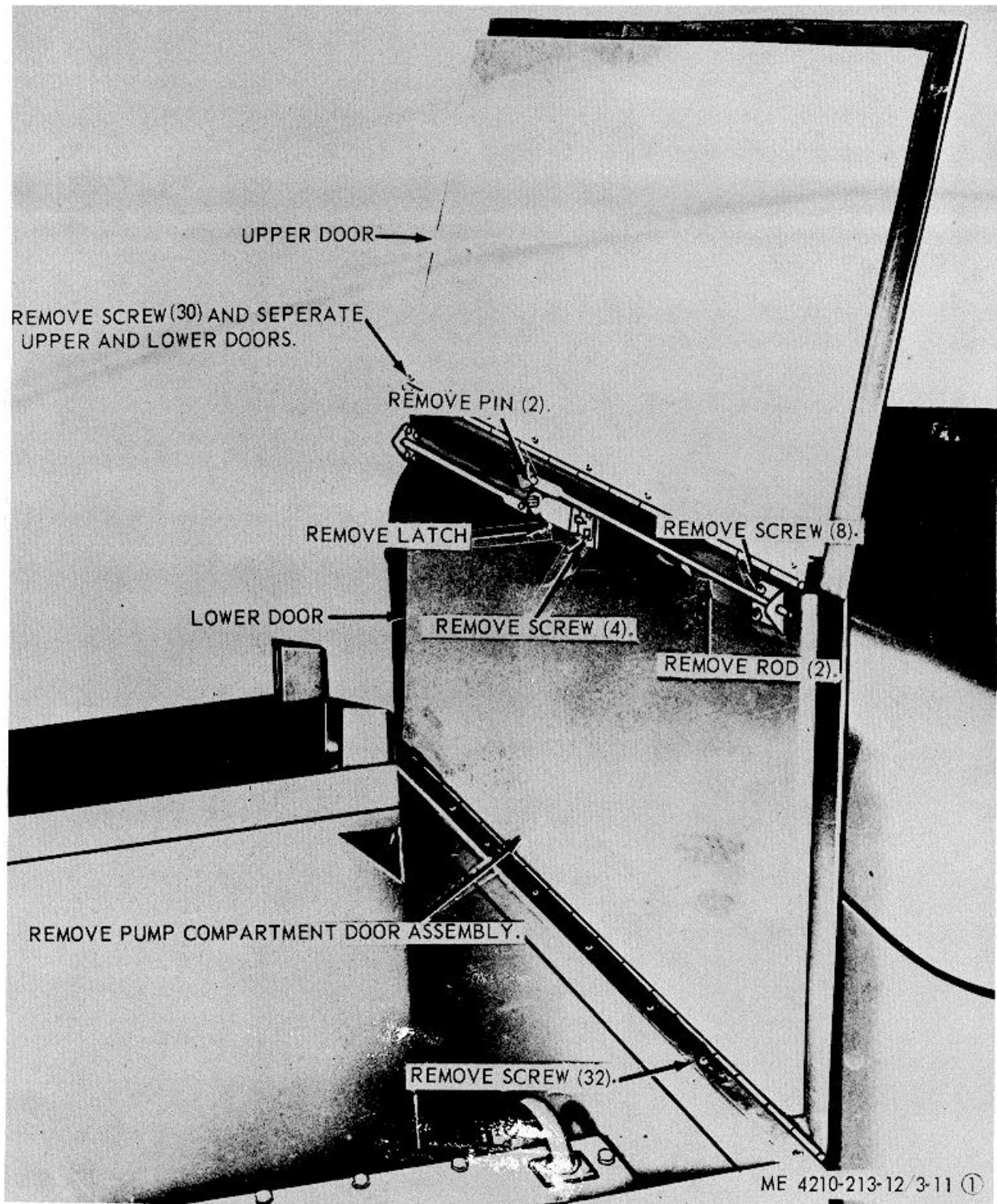

Figure 3-11. Pump and hose reel compartment door assemblies, removal and installation.

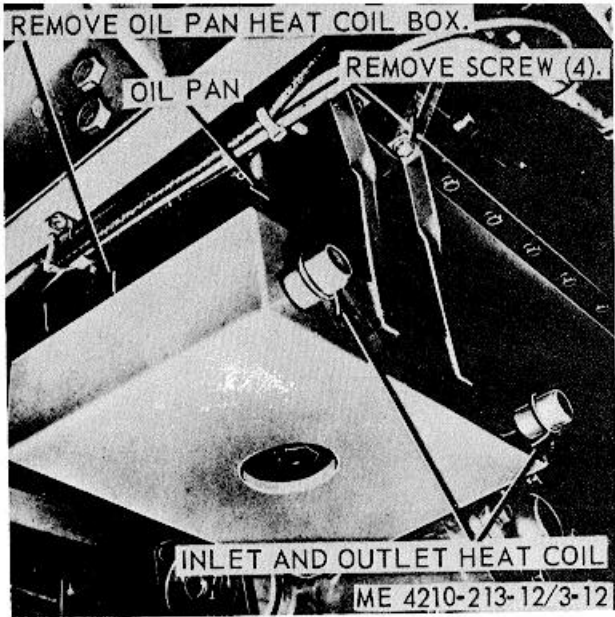
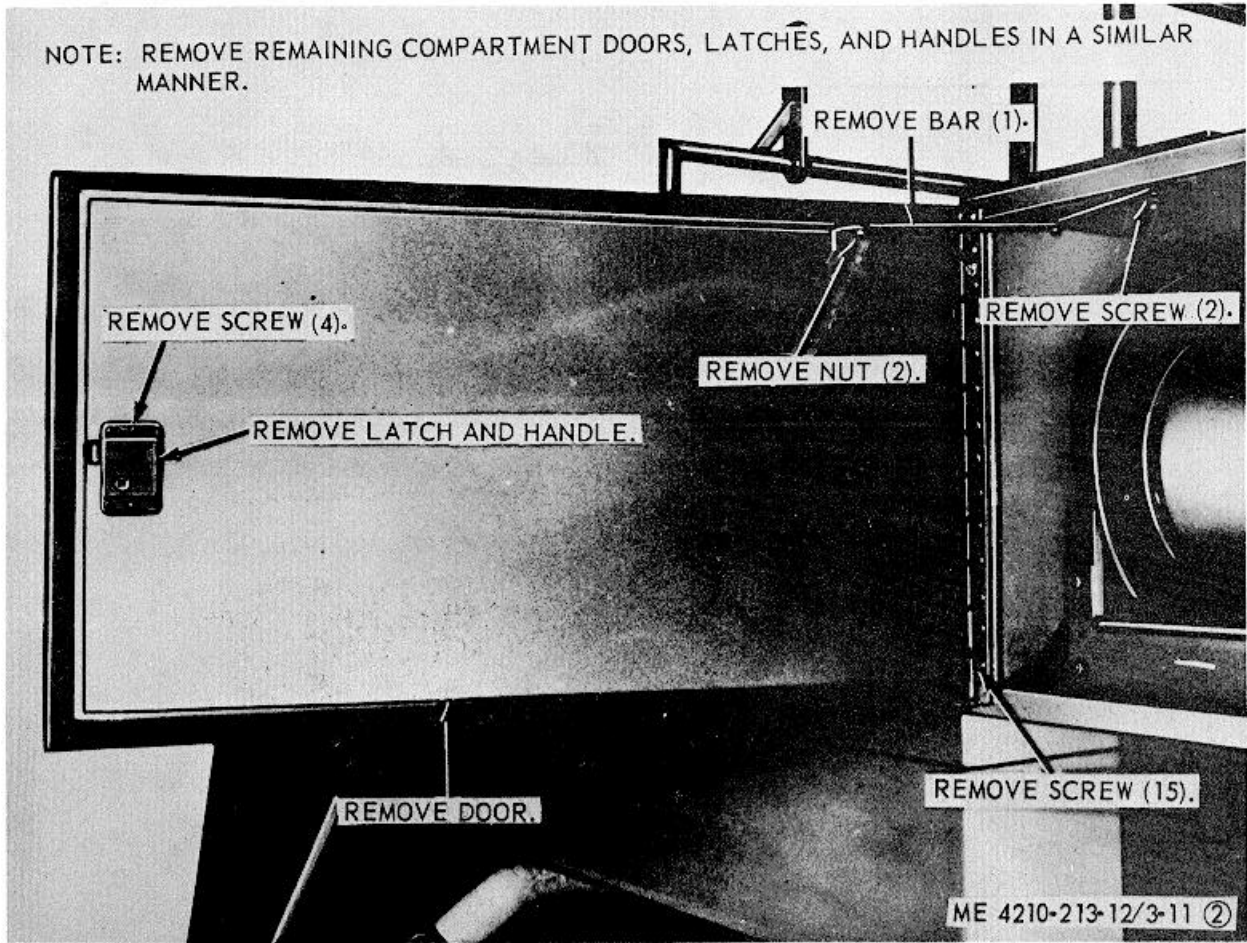

Figure 3-12. Oil pan heater adapter, removal and installation.

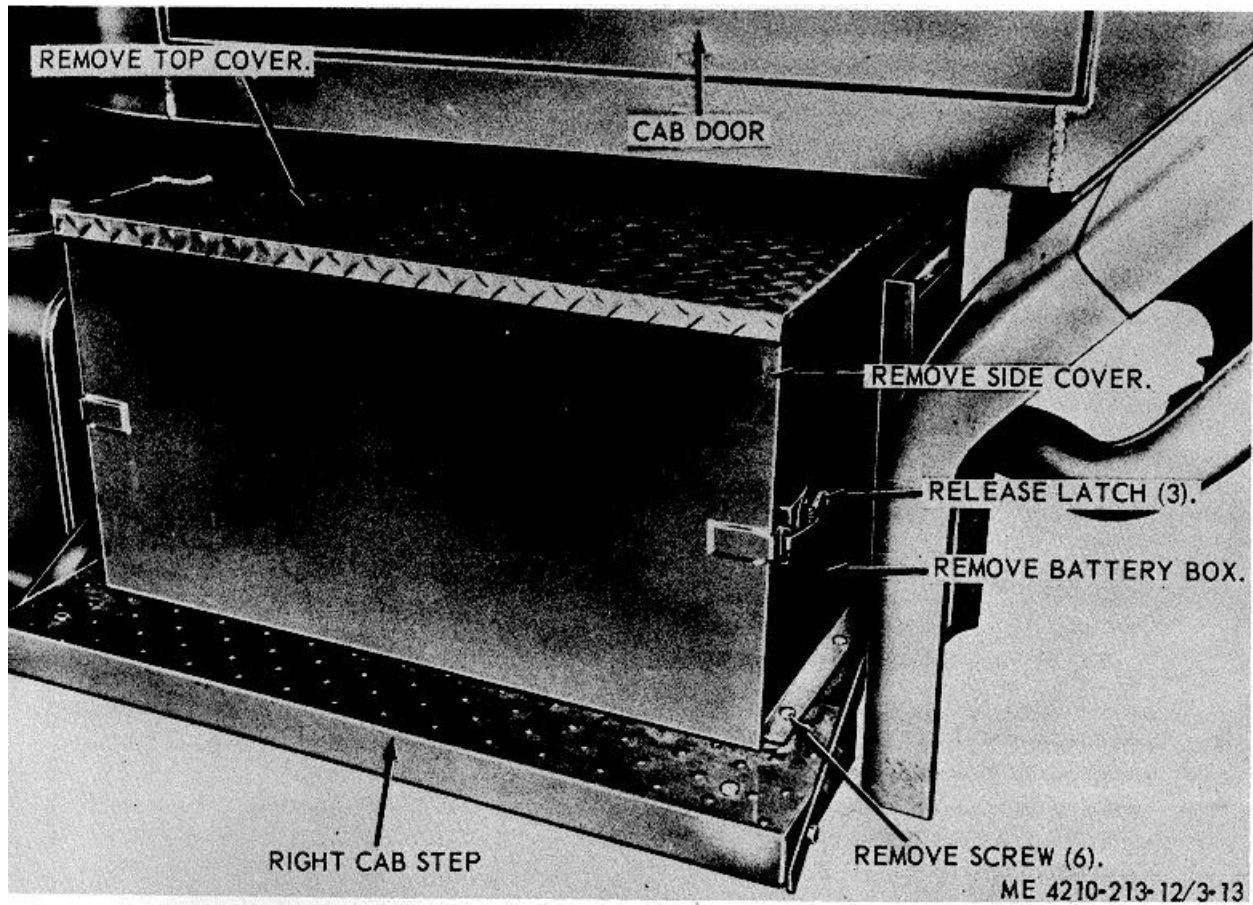

Figure 3-13. Battery box, removal and installation.

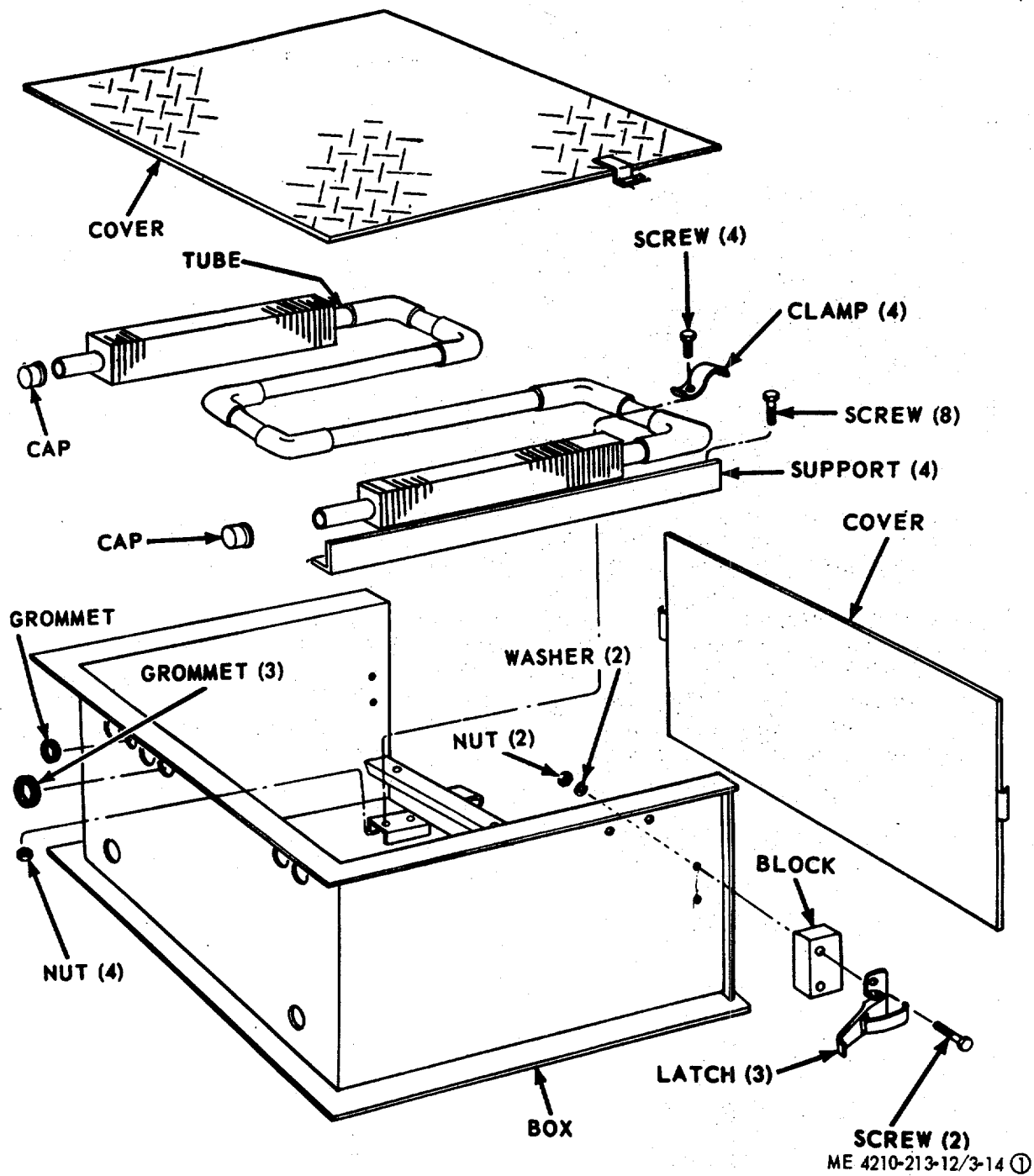

Figure 3-14. Battery box, exploded view.

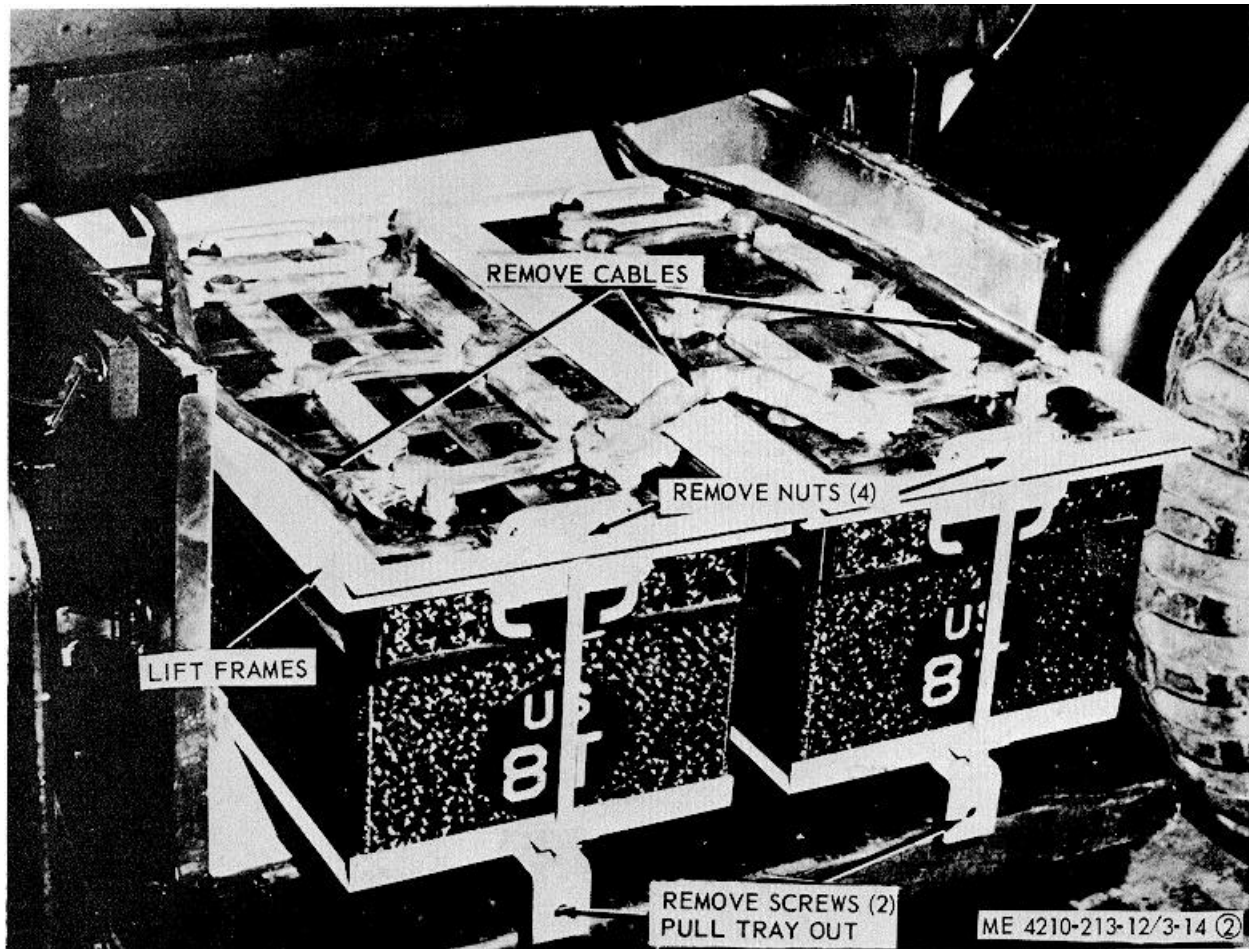
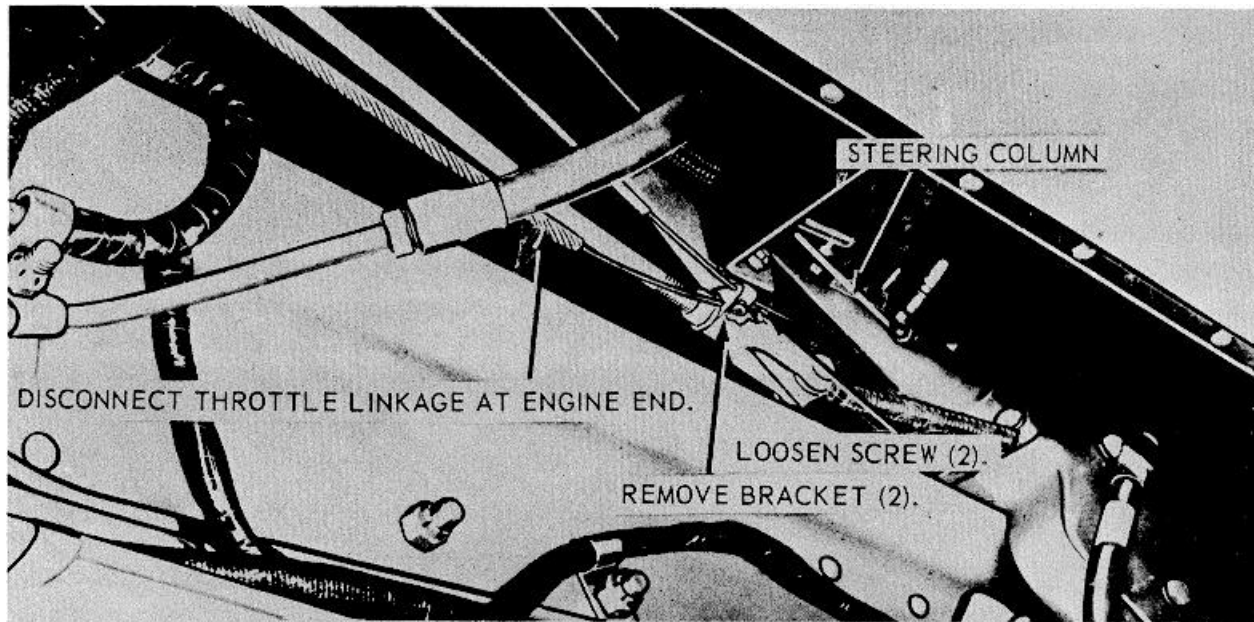
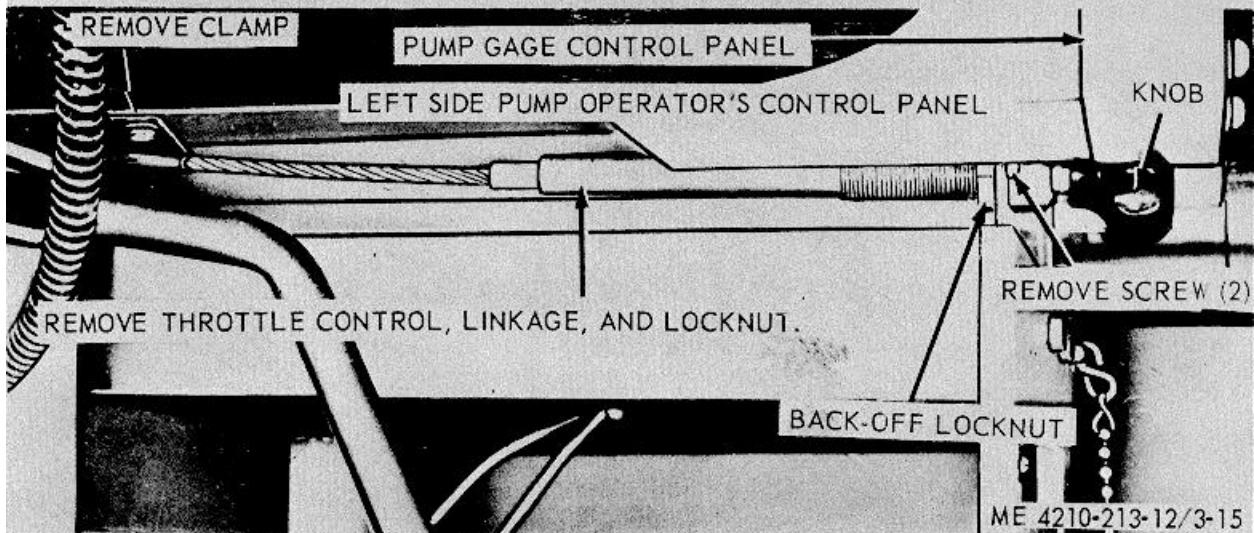

Figure 3-14A. Battery and battery cables.



A. THROTTLE LINKAGE, BOTTOM VIEW



B. THROTTLE LINKAGE, SIDE VIEW

Figure 3-15. Throttle control and linkage, removal and installation.

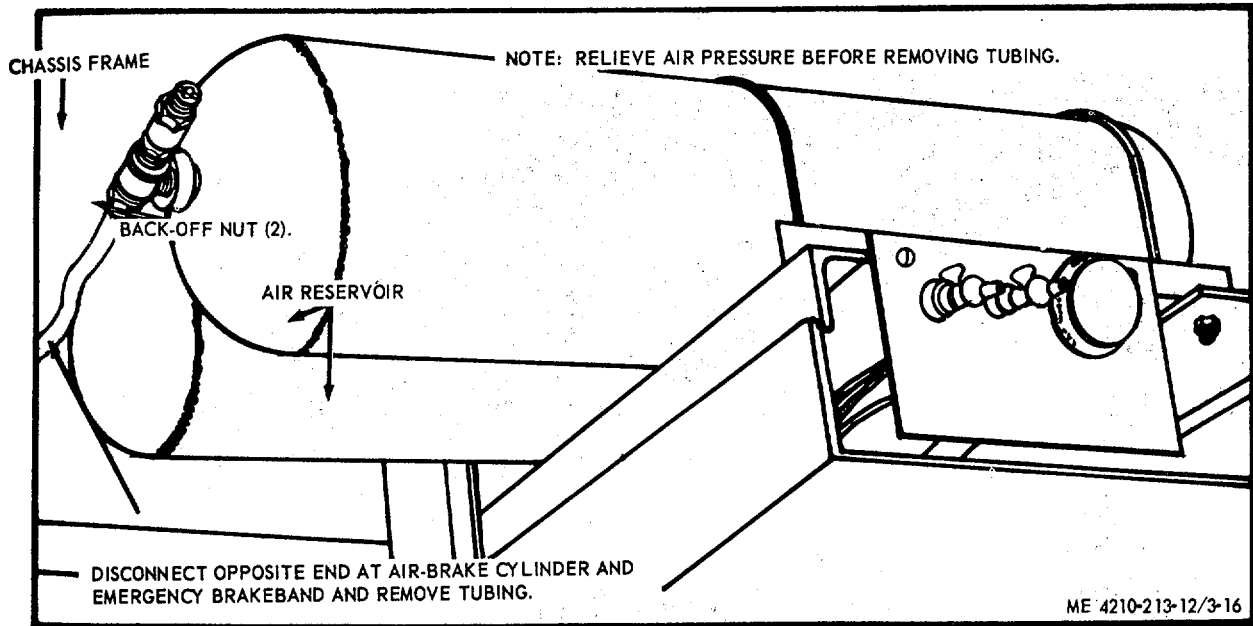

Figure 3-16. Air Tank tubing and fittings, removal and installation.

Section XI. ELECTRICAL SYSTEM

3-48. General

The electrical system consists of two spotlights, one mounted on each of the windshield posts, two rear spotlights mounted on the rear of the fire truck, and electrical siren mounted on the left front fender, rotating warning light mounted on the top of the cab. These lights are waterproof, sealed-beam-type lamps. A flasher assembly mounted behind the cab instrument panel functions to interrupt the circuit to directional light assemblies. A dome light mounted above the left side control panel furnished illumination for pump operating controls. A temperature warning light, oil pressure warning light, and two panel lights are mounted in the instrument panel on the left side. Two underhood lights mounted on each side of the front of the radiator furnish illumination for the engine. Two solenoid relays and motors, one mounted on each hose reel assembly and one motor solenoid and motor mounted on the priming pump serve to furnish power for the priming pump and hose reels! There are two battery charging receptacles located at the rear of the vehicle. Two

12 volt batteries and their cable assemblies supply power to the unit. The temperature and oil pressure sending units are mounted on the engine. Refer to T M 9-2320-209-10 for the chassis and engine electrical components.

3-49. Wiring

- a. *General.* When testing, repairing, or -replacing the wiring, refer to wiring diagram (fig- 1-3).
- b. *Testing.* Test a wire for continuity by disconnecting each end from the components to which it is connected. Touch' the test probes of a multimeter to each end of the wire. If continuity is not indicated, the wire is defective and must be repaired or replaced.
- c. *Repair.* Shave the insulation on the wire at both ends of the break and twist the bare wires together and solder the Connection. Cover the- repaired' breaks with electrical tape and friction tape. If a terminal breaks off a wire, replace it, using a like terminal.
- d. *Replacement.* Replace a wire by disconnecting it from the component or components and remove the wire. Install a new wire and attach it to the outside of the-wiring harness.

3-50. Siren and Flasher Light

a. *Removal.* Refer to figure 3-17 and remove the siren and flasher light from the fire truck fender.

b. *Disassembly.* Refer to figure 3-18 and disassemble the siren and flasher light.

c. *Cleaning, Inspection, and Repair.*

(1) Clean all parts with a clean cloth dampened in an approved cleaning solvent, and dry thoroughly.

(2) Inspect all parts for damaged or defective condition.

(3) Replace or repair damaged or defective parts as necessary.

d. *Reassembly.* Refer to figure -18 and reassemble the siren and flasher light in the reverse order.

e. *Installation.* Refer to figure 3-17 and install the siren and flasher light On the fire: truck fender.

3-51. Spotlight

a. *Removal.* Refer to figure 3-19, and remove the spotlight from the fire truck cab.

b. *Cleaning, Inspection, and Repair.*

(1) Clean all parts with a clean cloth dampened in an approved Cleaning solvent, and dry thoroughly

(2) Inspect all parts for damaged or defective condition.

(3) Replace or repair damaged or defective parts as necessary.

c. *Installation.* Refer to figure 3-19, and install the spotlight on the fire truck cab.

3-52. Warning Light

a. *Removal.* Refer to figure 3-20, and remove the warning light from the fire truck.

b. *Disassembly.* Refer to figure 3-21, and disassemble the warning light.

c. *Inspection, and Repair.*

(1) Inspect all parts for damaged or defective condition.

(2) Replace or repair damaged or defective parts as necessary.

d. *Reassembly.* Refer to figure 3-21, and reassemble the warning light in the reverse order.

e. *Installation,.* Refer to figure 3-20, and install the warning light on the fire truck cab.

3-53. Underhood Lights

a. *Removal.* Refer to figure 3-22, and remove the underhood lights from the fire truck radiator mounting bracket.

b. *Cleaning, Inspection, and Repair.*

(1) Clean all parts with a clean cloth dampened in an approved cleaning solvent, and dry thoroughly.

(2) Inspect all parts for damaged or defective condition.

(3) Replace or repair damaged or defective parts as necessary.

c. *Installation.* Refer to figure 3-22, and install the underhood lights on the fire truck radiator mounting bracket.

3-54. Siren Solenoid Relay

Refer to figure 3-23, and remove and replace defective siren solenoid relay from the engine compartment.

3-55. Engine Oil Pressure Sending Unit

Refer to figure 3-24, and remove and replace defective engine oil pressure sending unit from the engine.

3-56. Engine Temperature Sending Unit

Refer to figure 3-25, and remove and replace defective engine temperature sending unit from the engine.

3-57. Circuit Breakers

Refer to figure 3-26, and remove and replace defective circuit breakers from the cab fire wall.

3-58. Siren anal Warning Light Switch

Refer to figure -27, and remove and replace defective warning light switch from the instrument panel.

3-59. Siren Hand Switch

Refer to figure 3-27, and remove and replace defective siren hand switch from the steering column.

3-60. Siren Foot Switch

Refer to figure 3-28, and remove and replace defective siren foot switch from the cab floor

3-61. Pump Gaffe Panel Warning light

a. *Removal.* Refer to figure 3-29, and re

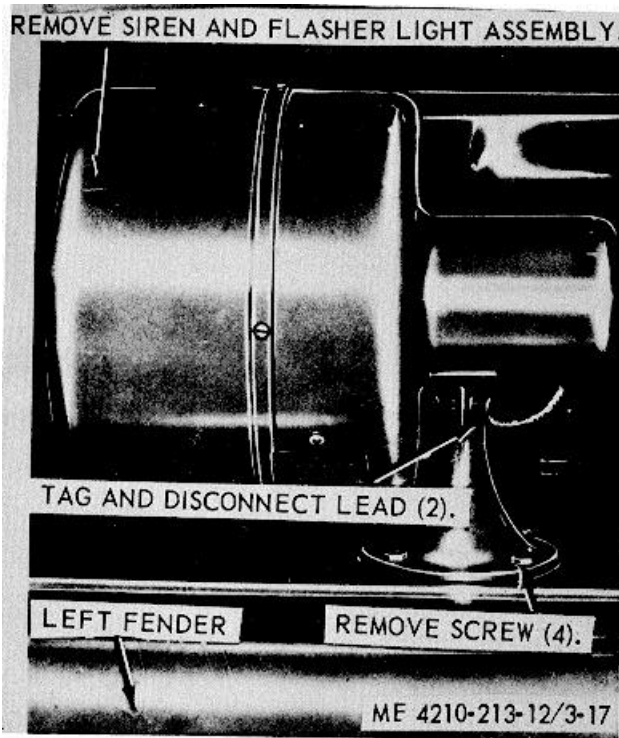

Figure 3-17. Siren and flasher light, removal and installation.

remove the pump gage panel warning light from the pump gage panel.

b. Cleaning, Inspection, and Repair.

(1) Clean all parts with a clean cloth dampened in an approved cleaning solvent, and dry thoroughly.

(2) Inspect all parts for damaged or defective condition.

(3) Replace or repair damaged or defective parts as necessary.

c. Installation. Refer to figure 3-29, and install the pump gage panel warning light on the pump gage panel.

3-62. Pump Gage Panel Light

a. Removal. Refer to figure 3-29, and remove the pump gage panel light from the; pump gage panel.

b. Cleaning Inspection and Repair.

(1) Clean all parts with a clean cloth dampened in an approved cleaning solvent, and dry thoroughly.

(2) Inspect all parts for damaged or defective condition.

(3) Replace or repair damaged or defective parts as necessary.

c. Installation. Refer to figure 3-29, and install pump panel lights on the pump gage panel.

3-3. Dome light

a. Removal. Refer to figure 3-0, and remove the dome light from the special purpose body.

b. Inspection, and Repair.

(1) Inspect all parts for damaged or defective condition.

(2) Replace or repair damaged or defective parts as necessary.

c. Installation. Refer to figure 3 30, and install the dome light on the special purpose body.

3-64. Dome light Switch

Refer to figure 3-30, and remove and replace defective dome light switch from the instrument panel.

3-65. Pump Gage Panel Light Switch

Refer to figure 3-0, and remove and replace defective pump gage panel light switch from the instrument panel.

3-66. Engine Light Switch

Refer to figure 3-30, and remove and replace defective-engine light switch from the instrument panel.

3-67. Hose Reel Switch

Refer ' to figure 3-0, and remove and replace defective hose reel switch from the instrument panel.

3-68. Hose Reel Motor Solenoid Relay Refer to figure 3-1, and remove and replace defective 'hose reel motor solenoid relay from the hose' reel.

3-69. Hose Reel Motor Refer to figure 3-31' and remove and replace defective hose reel motor from hose reel.

3-70. Primer Pump Motor Solenoid Relay Refer to figure 3-2, and remove and replace defective primer pump motor solenoid relay from the primer pump.

3-71. Primer Pump Motor Refer to figure 3-32, and remove and replace defective primer pump motor from the primer pump.

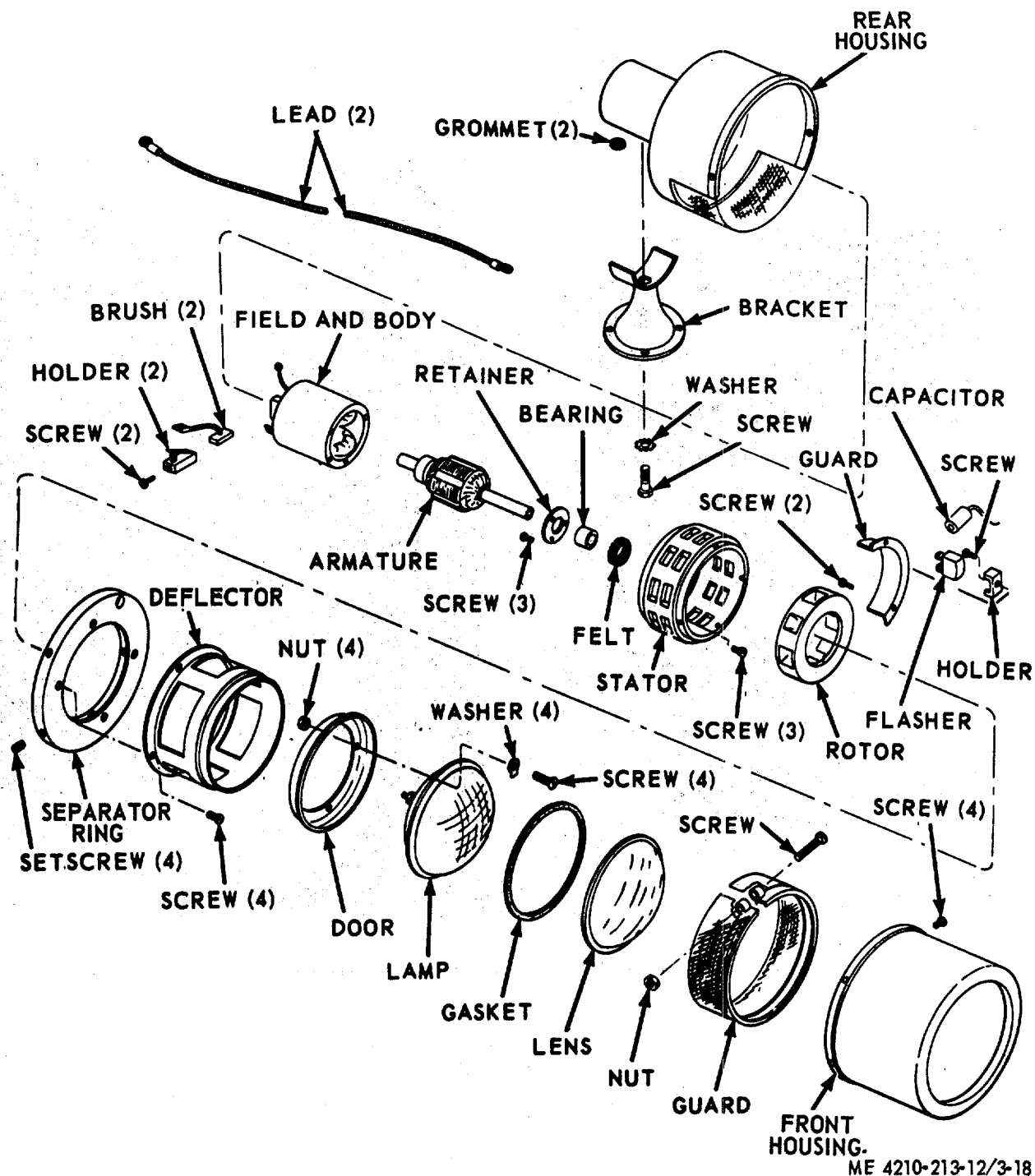

Figure 3-18. Siren and flasher light, exploded view.

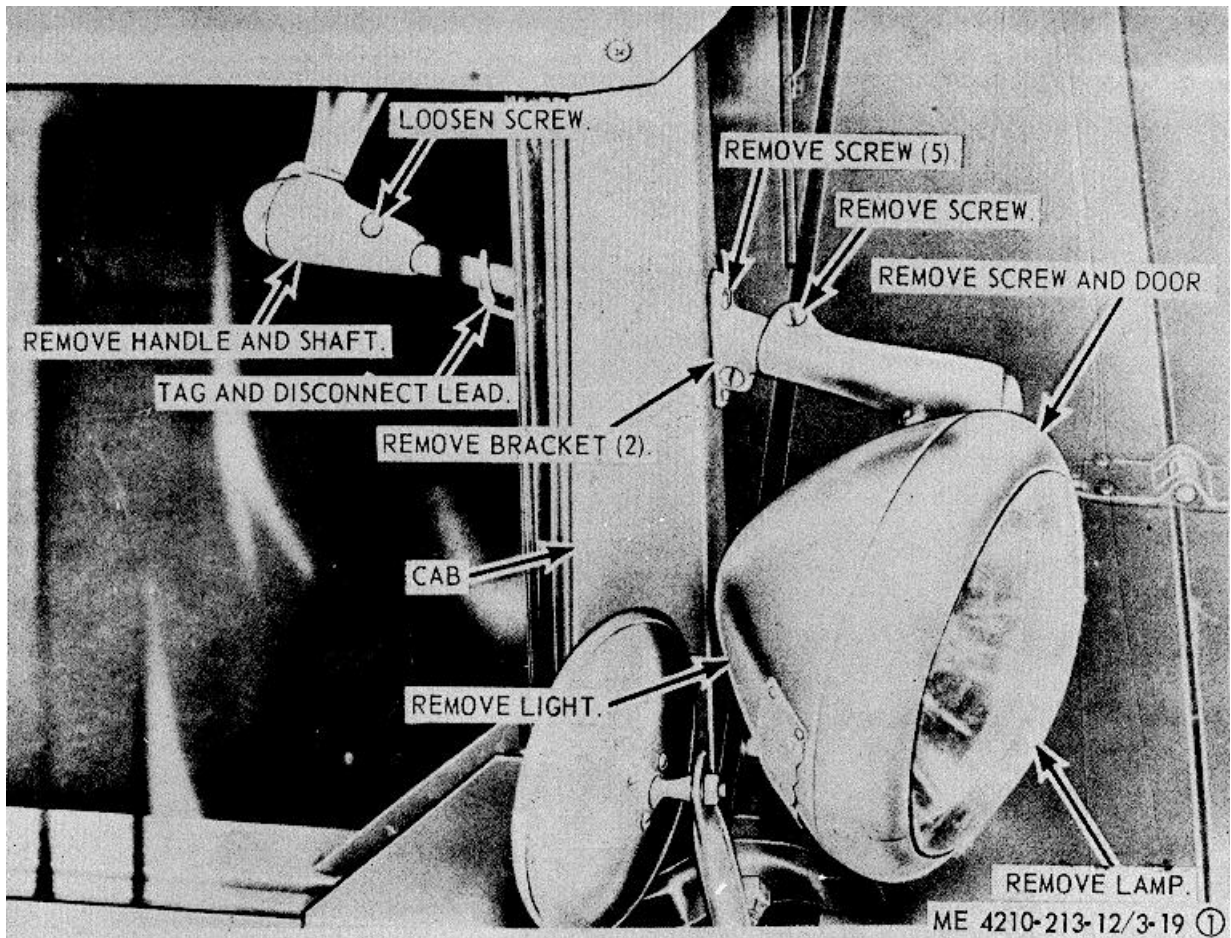
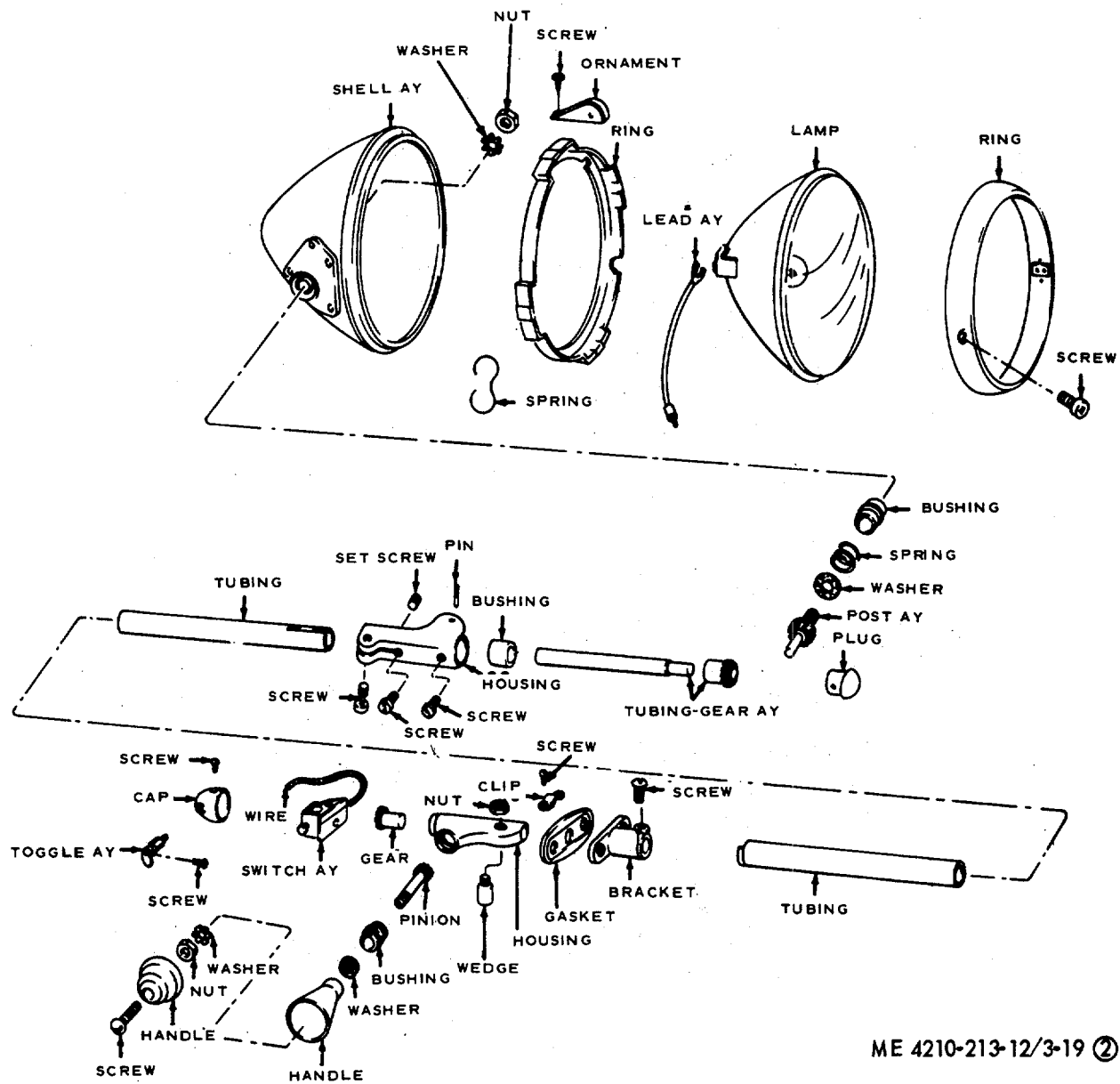

Figure 3-19. Spotlight, removal and installation.



ME 4210-213-12/3-19 ②

Figure 3-19A. Front floodlight, exploded view.

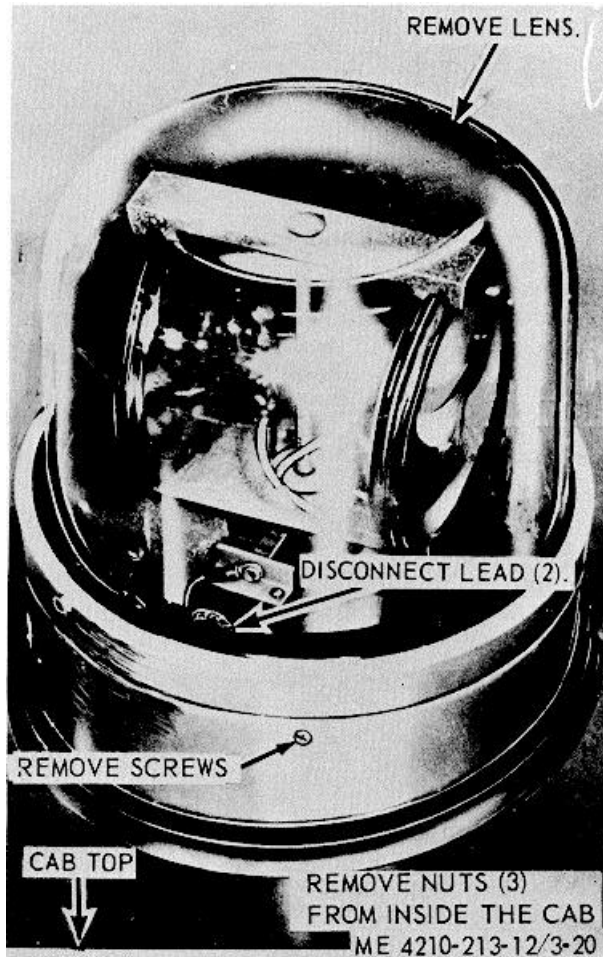
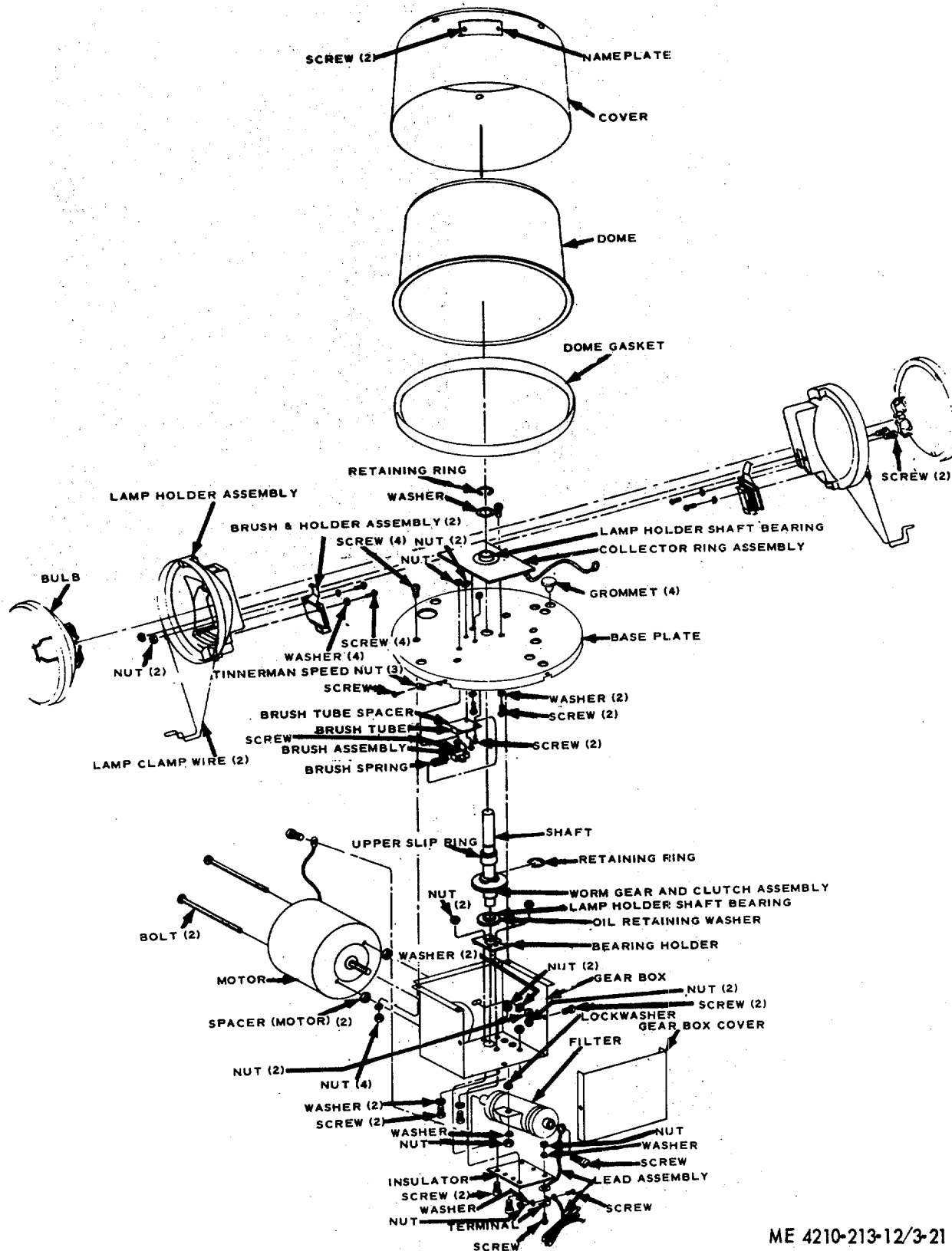

Figure 3-20. Warning light removal and installation.



ME 4210-213-12/3-21

Figure 3-21. Warning light, exploded view.

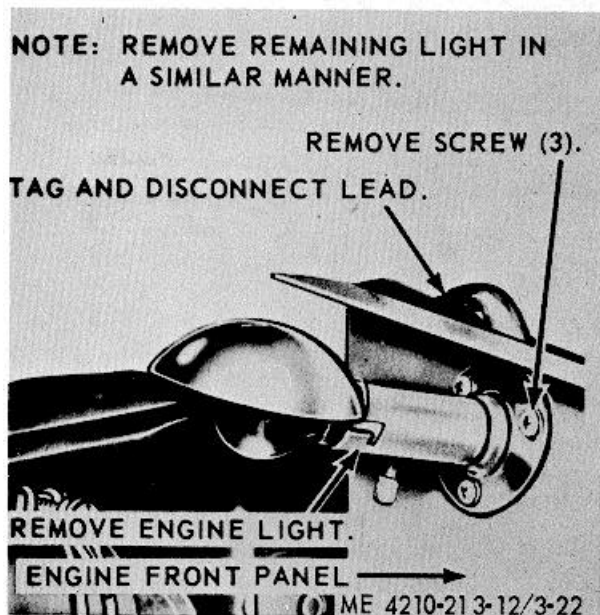

Figure 3-22. Underhood lights, removal and installation.

Figure 3-23. Siren solenoid relay, removal and installation.

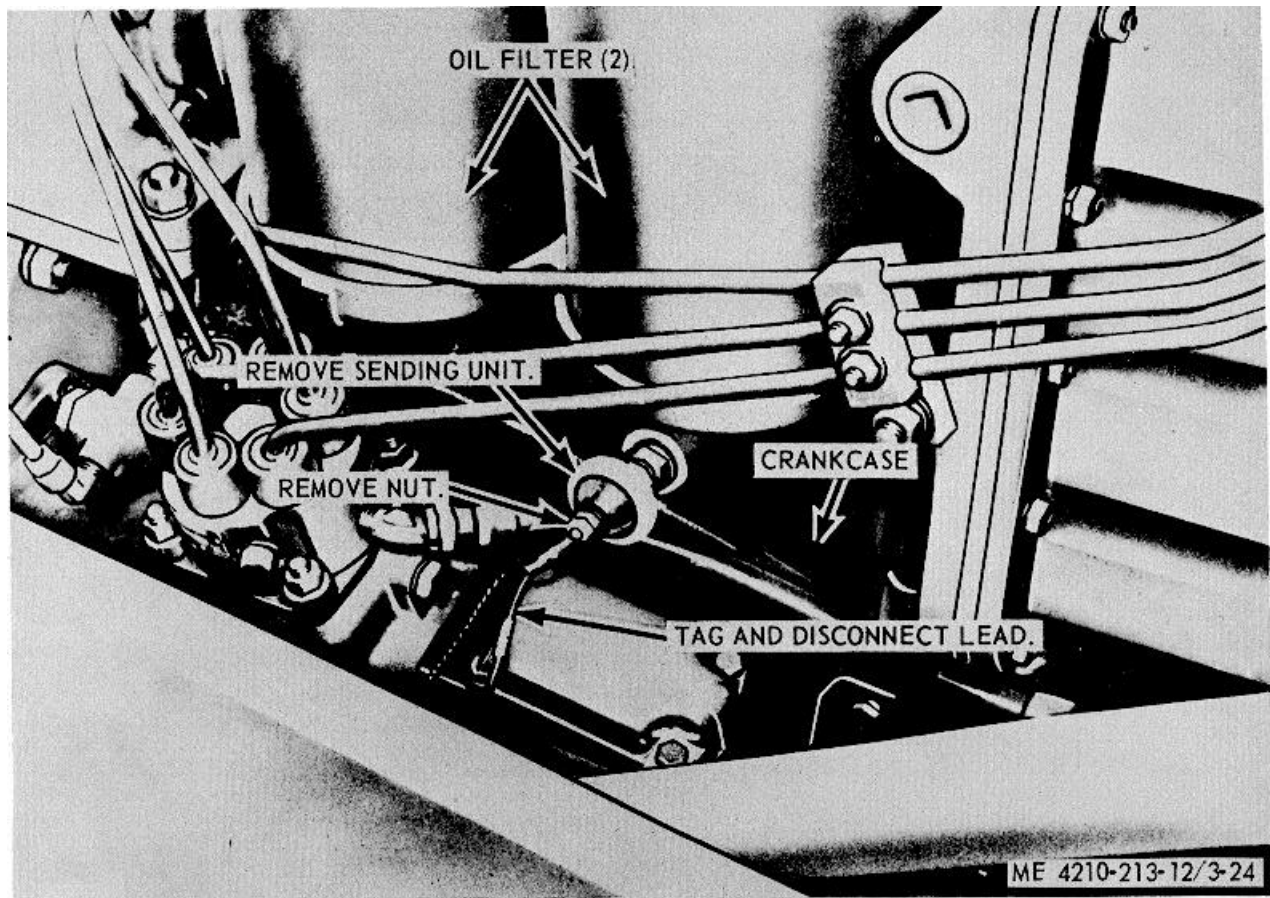

Figure 3-24. Engine oil pressure sending unit, removal and installation

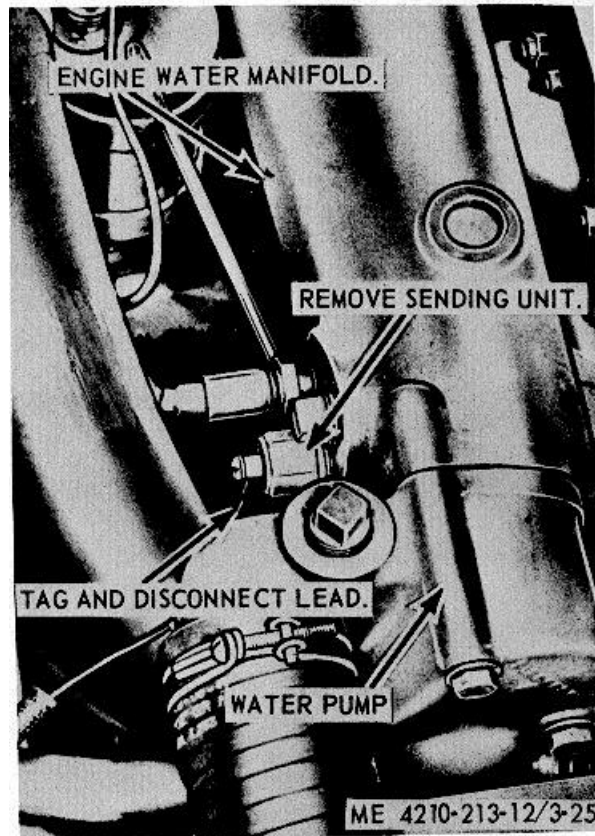

Figure 3-25. Engine temperature sending removal and installation.

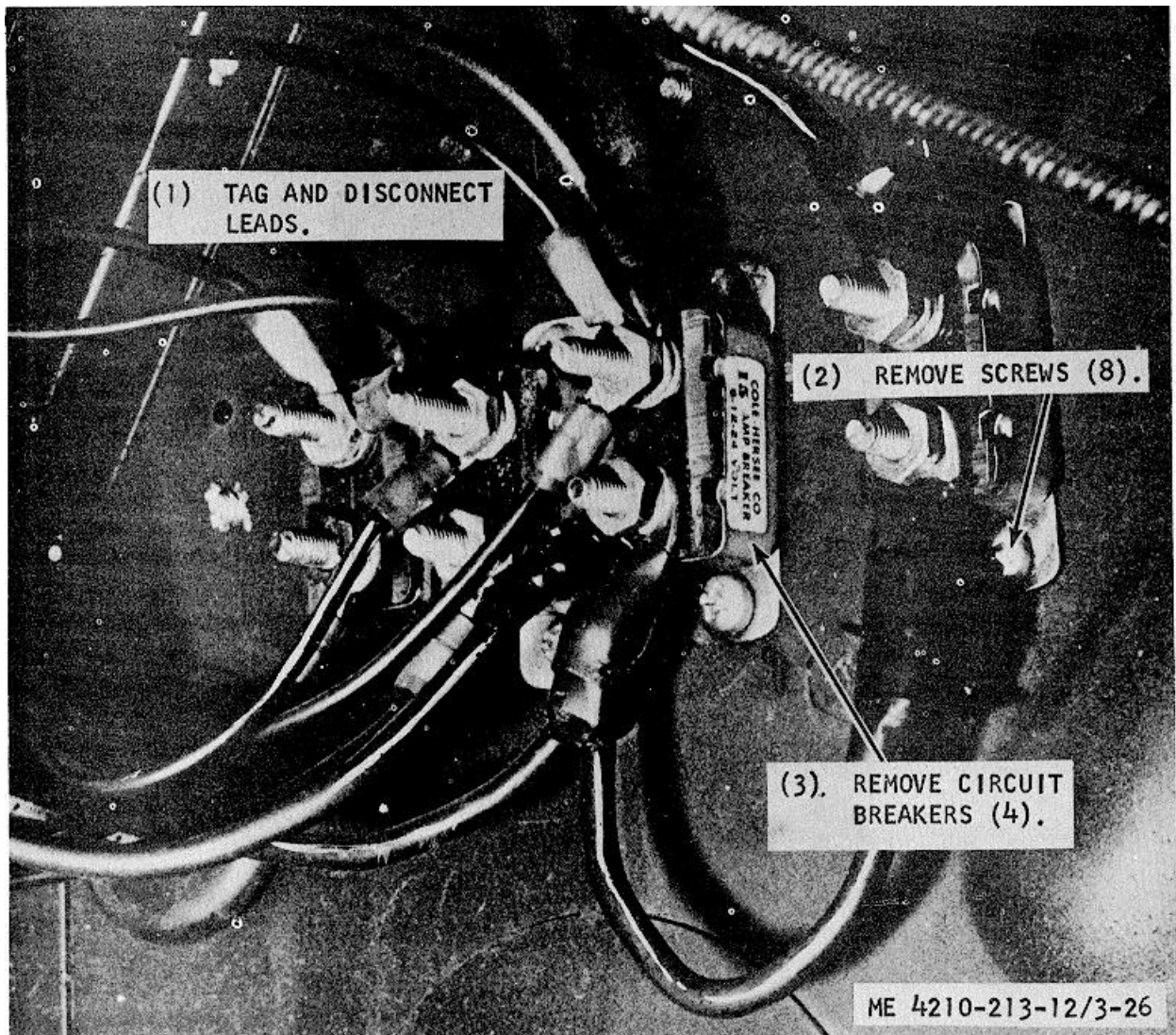

Figure 3-26. Circuit breakers, removal and installation.

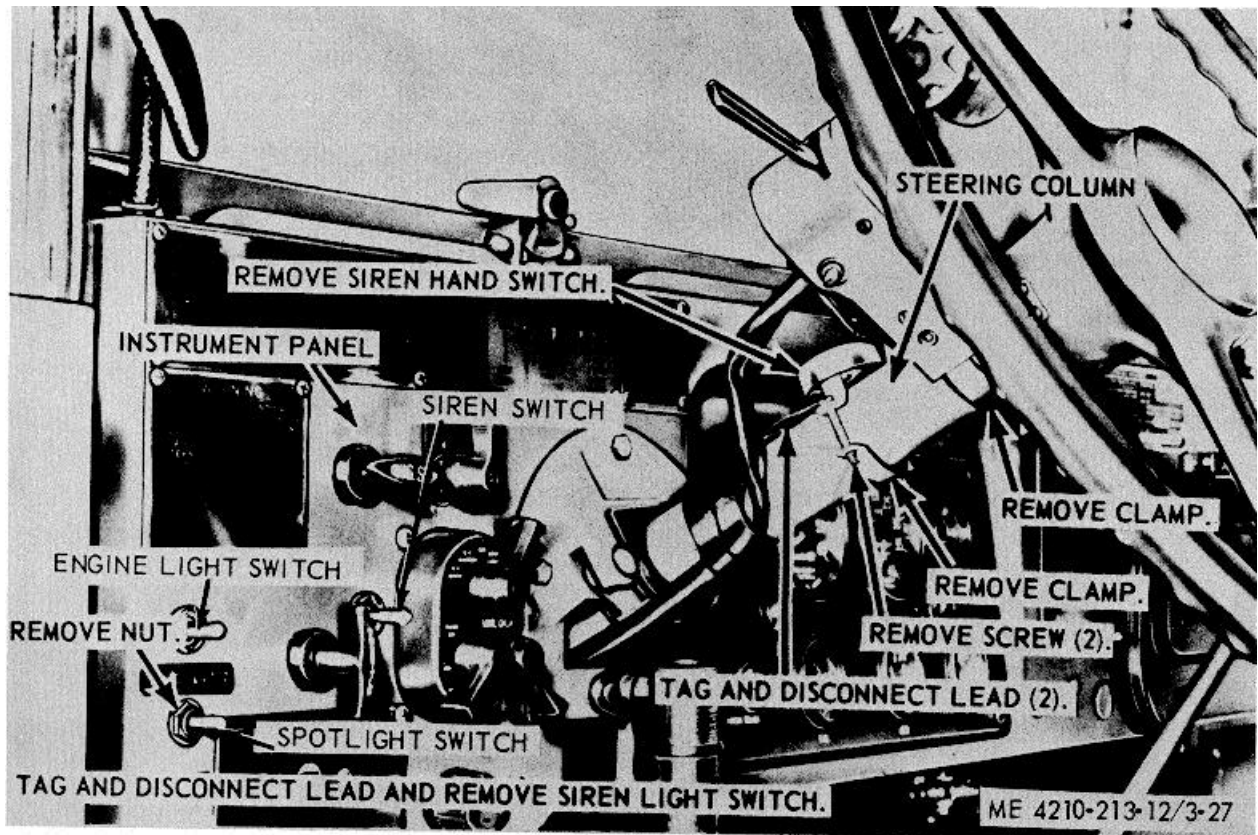

Figure 3-27. Warning light switch and siren light switch, removal and installation.



Figure 3-28. Siren foot switch, removal and installation.

3-72. Microswitch

Refer to figure 3-32, and remove and replace defective microswitch from the primer valve.

3-73. Rear Spot light

a. *Removal.* Refer to figure 3-33, and remove the rear ILO spotlight from the ladder support.

b. *Cleaning, Inspection, and Repair.*

(1) Clean all parts with a clean cloth dampened in an approved cleaning solvent, and dry thoroughly.

(2) Inspect all parts for damaged or defective condition.

(3) Replace or repair damaged or defective parts as necessary.

c. *Installation.* Refer to figure 3-33, and install the rear ILO spotlight on the fire truck body.

3-74. Tail lights

a. *Removal.* Refer to figure 3-34, and remove the tail lights from the fire truck panel.

b. *Cleaning, inspection, and Repair.*

(1) Clean all parts with a clean cloth dampened in an approved cleaning solvent, and dry thoroughly.

(2) Inspect all parts for damaged or defective condition.

(3) Replace or repair damaged or defective parts as necessary.

c. *Installation.* Refer to figure 3-34, and install the tail lights on the fire truck panel.

3-75. Battery Charging Receptacles

a. *Removal.* Refer to figure 3-34, and remove the battery charging receptacles from the rear apron.

b. *Cleaning, Inspection, and Repair.*

(1) Clean all parts with a clean cloth dampened in an approved cleaning solvent, and dry thoroughly.

(2) Inspect all parts for damaged or defective condition.

(3) Replace or repair damaged or defective parts as necessary.

c. *Installation.* Refer to figure 3-34, and install the battery charging receptacles on the rear apron.

3-76. Battery and Battery Cables

a. *Removal.* Refer to figure 3-14A and remove and replace defective cables and batteries.

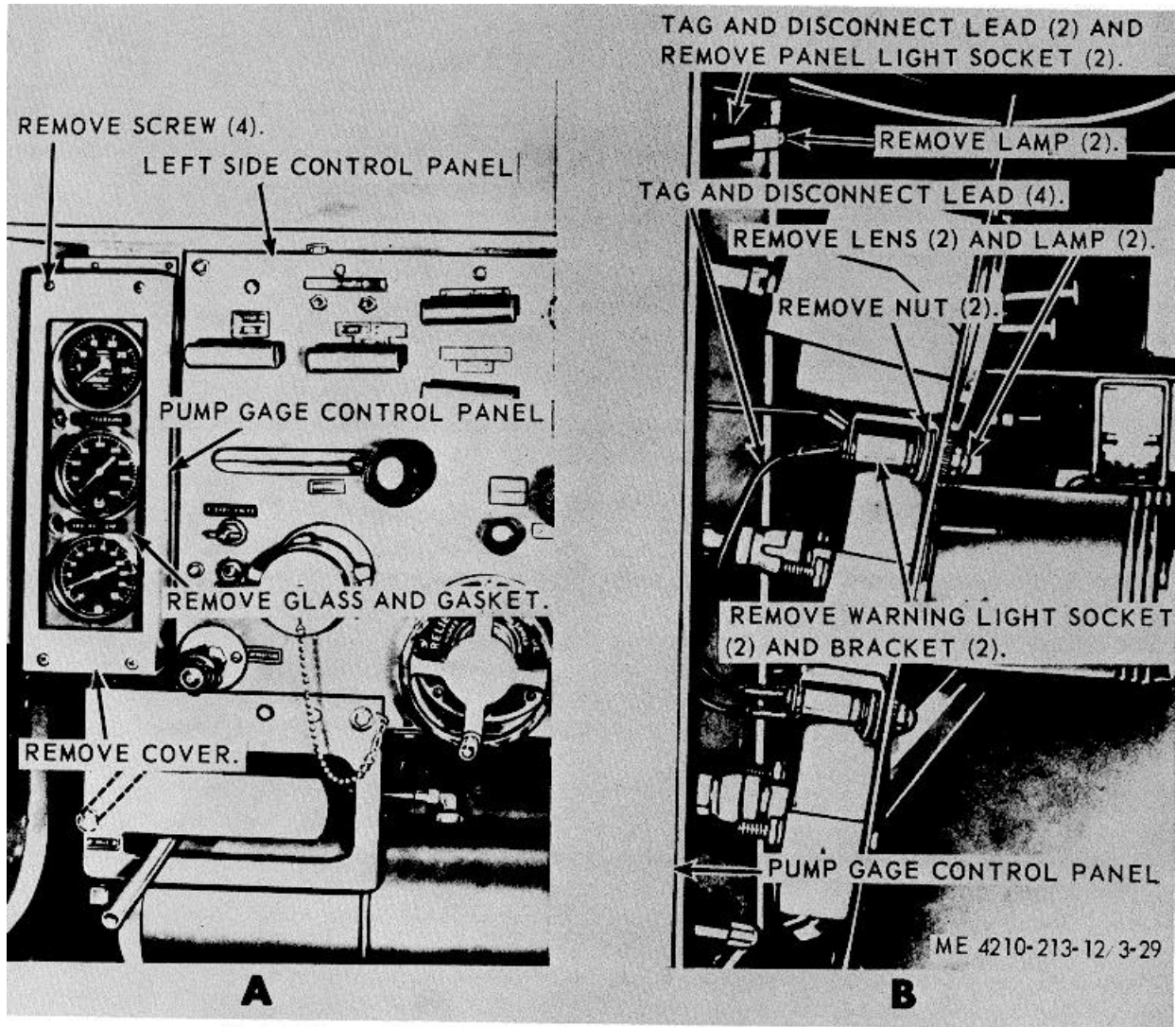

Figure 5-29. Warning lights and panel lights, removal and installation.

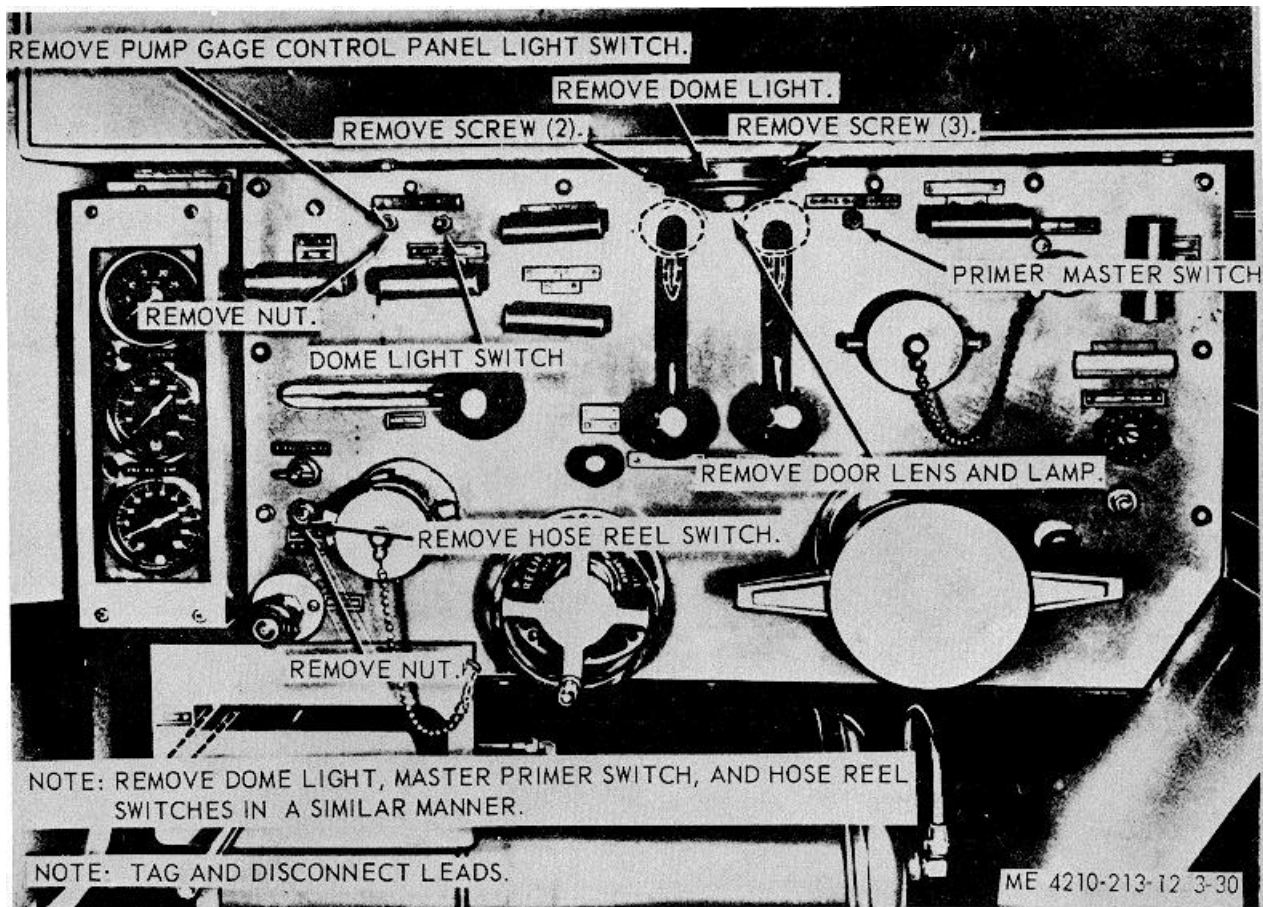

Figure 3-30. Dome light, and electrical control switches, removal and installation.

DRIVE CHAIN ADJUSTMENT

LOOSEN SCREW
TIGHTEN SCREW

MOVE MOTOR UP TO LOOSEN CHAIN, AND DOWN TO TIGHTEN CHAIN.
CHAIN DEFLECTION SHOULD BE 1 8 INCH BETWEEN DRIVES.

NOTE REMOVE REMAINING MOTOR
IN A SIMILAR MANNER.

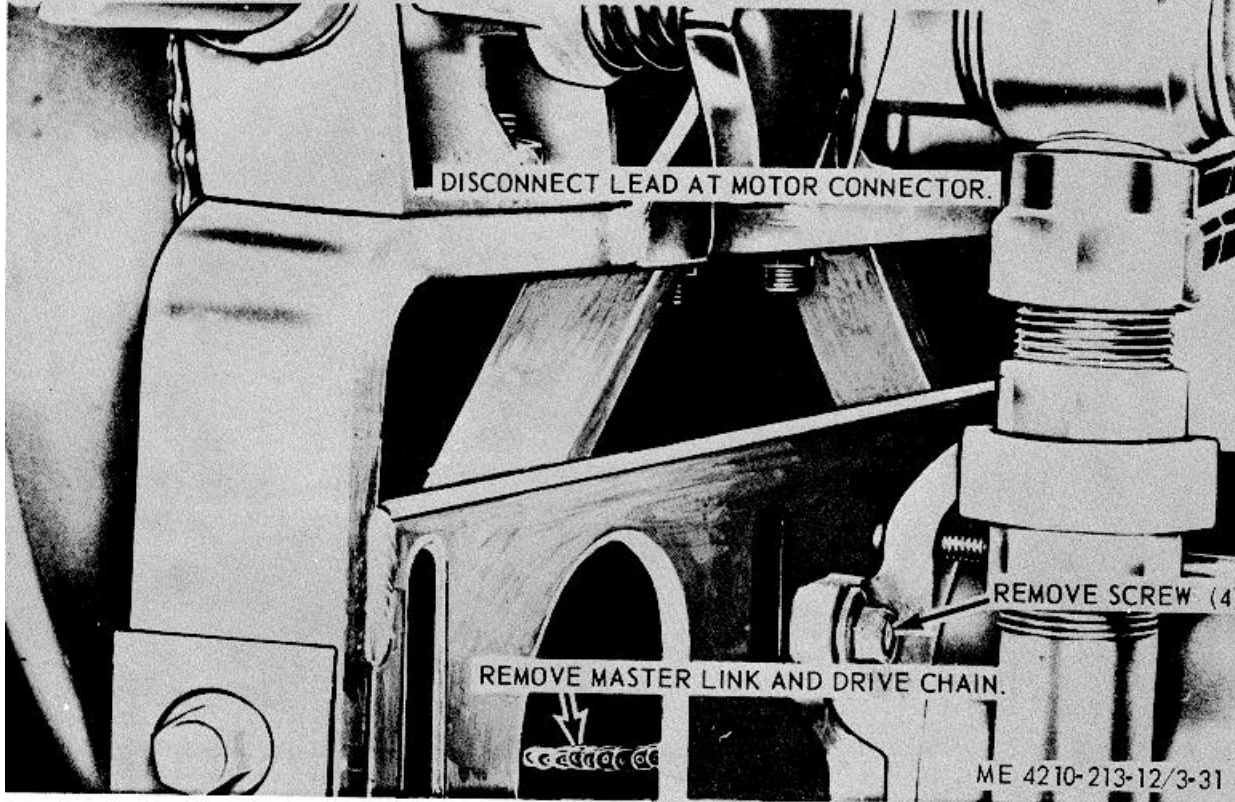

Figure 3-31. Hose reel motor, removal and installation.

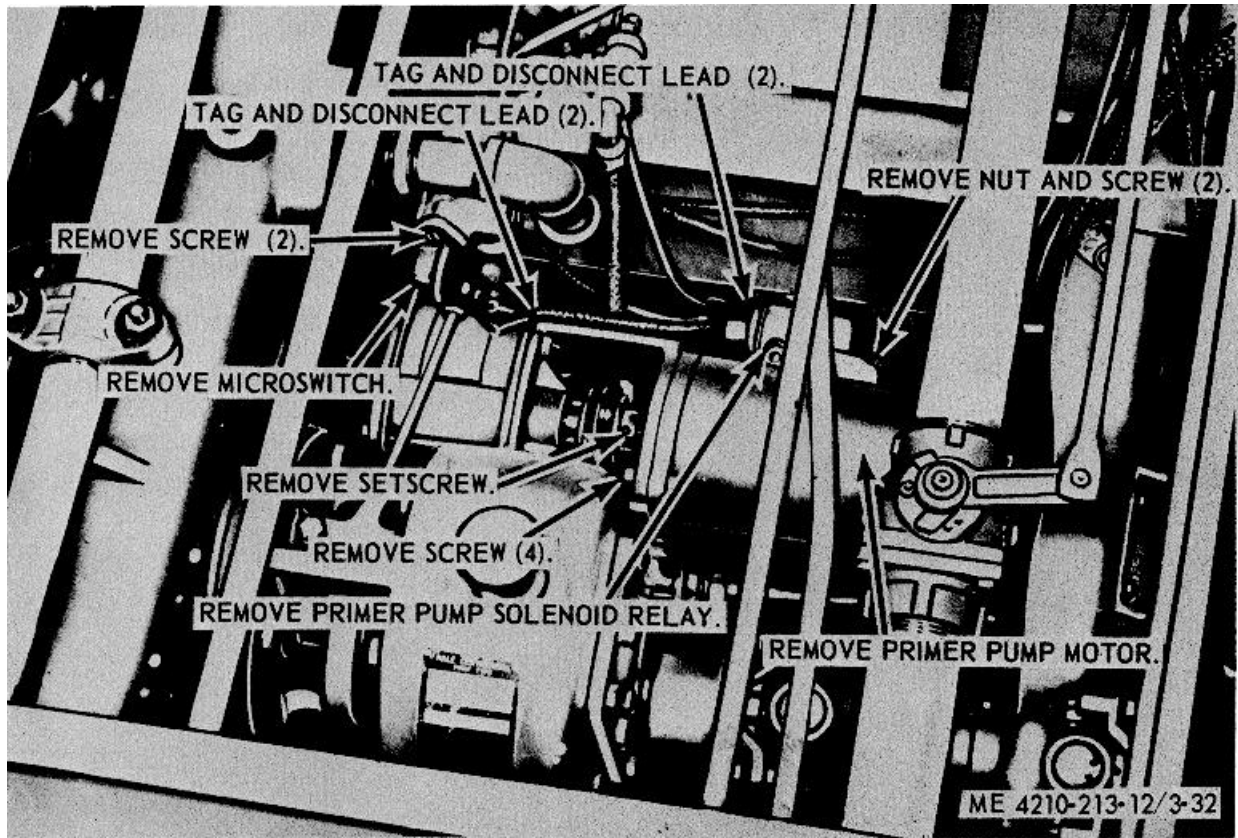

Figure 3-32. Primer pump solenoid, primer pump, and motor, removal and installation.

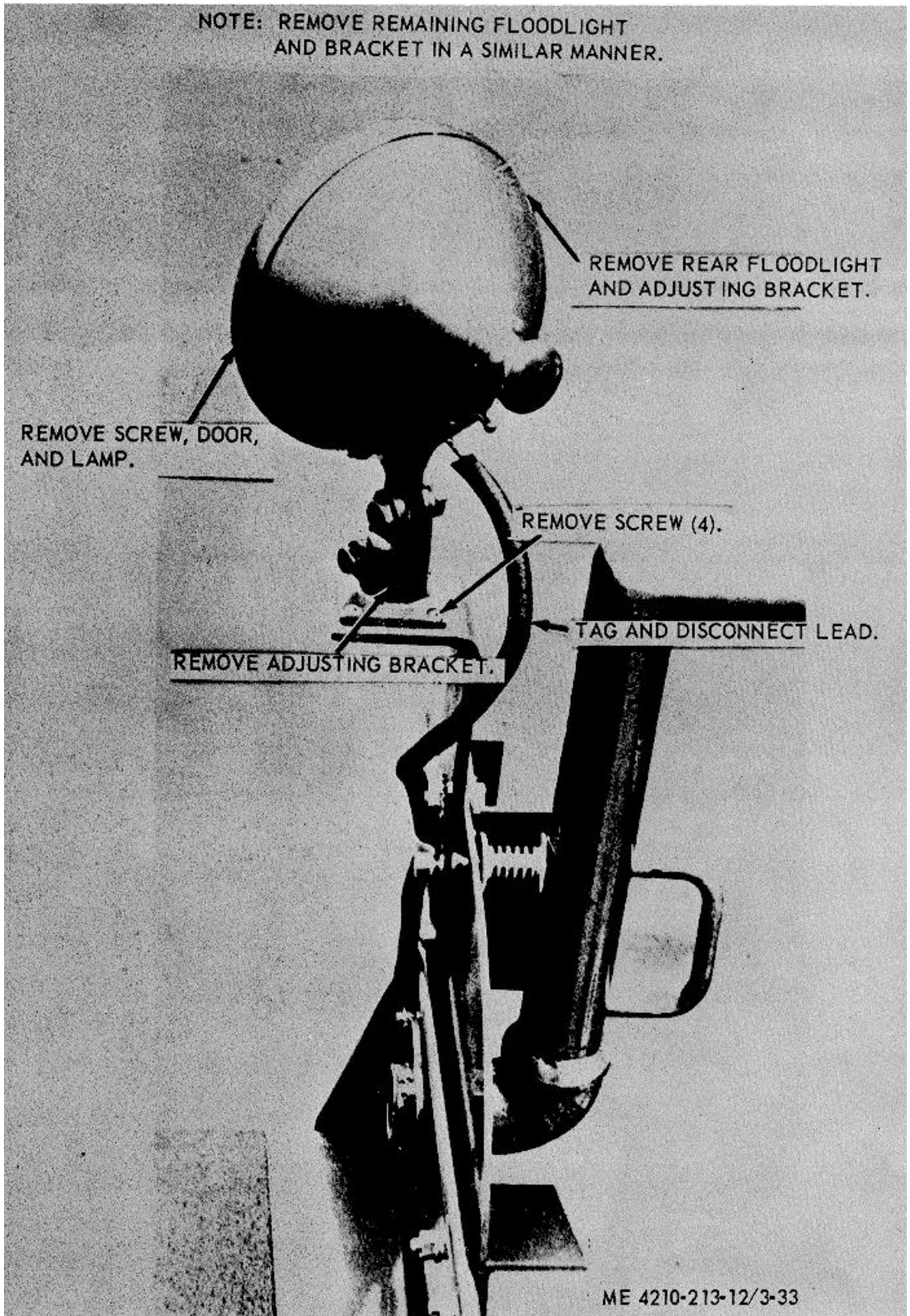
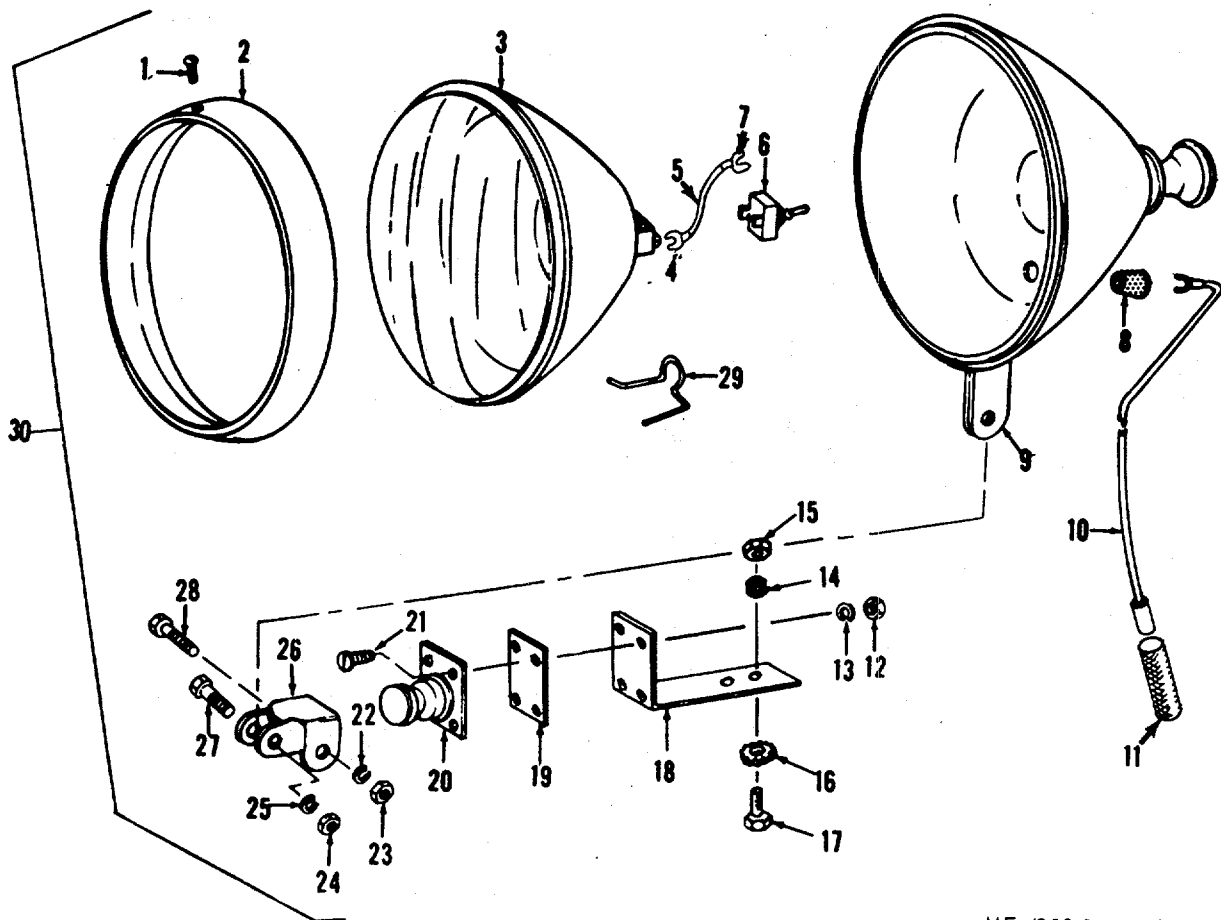

Figure 3-33. Rear ILO spotlight removal and installation.



ME 4210-213-12/3-33A

- | | |
|---------------------|-----------------------|
| 1 Screw | 16 Washer |
| 2 Ring assembly | 17 Screw |
| 3 Lamp | 18 Bracket |
| 4 Terminal | 19 Gasket |
| 5 Wire assembly | 20 Bracket |
| 6 Switch | 21 Screw |
| 7 Terminal | 22 Lockwasher |
| 8 Grommet | 23 Nut, plain |
| 9 Shell assembly | 24 Nut, plain |
| 10 Wire, electrical | 25 Lockwasher |
| 11 Tubing, flexible | 26 Housing |
| 12 Nut | 27 Bolt |
| 13 Lockwasher | 28 Screw, cap |
| 14 Lockwasher | 29 Spring |
| 15 Nut | 30 Spotlight assembly |

Figure 3-33A. Rear ILO spotlight exploded view.

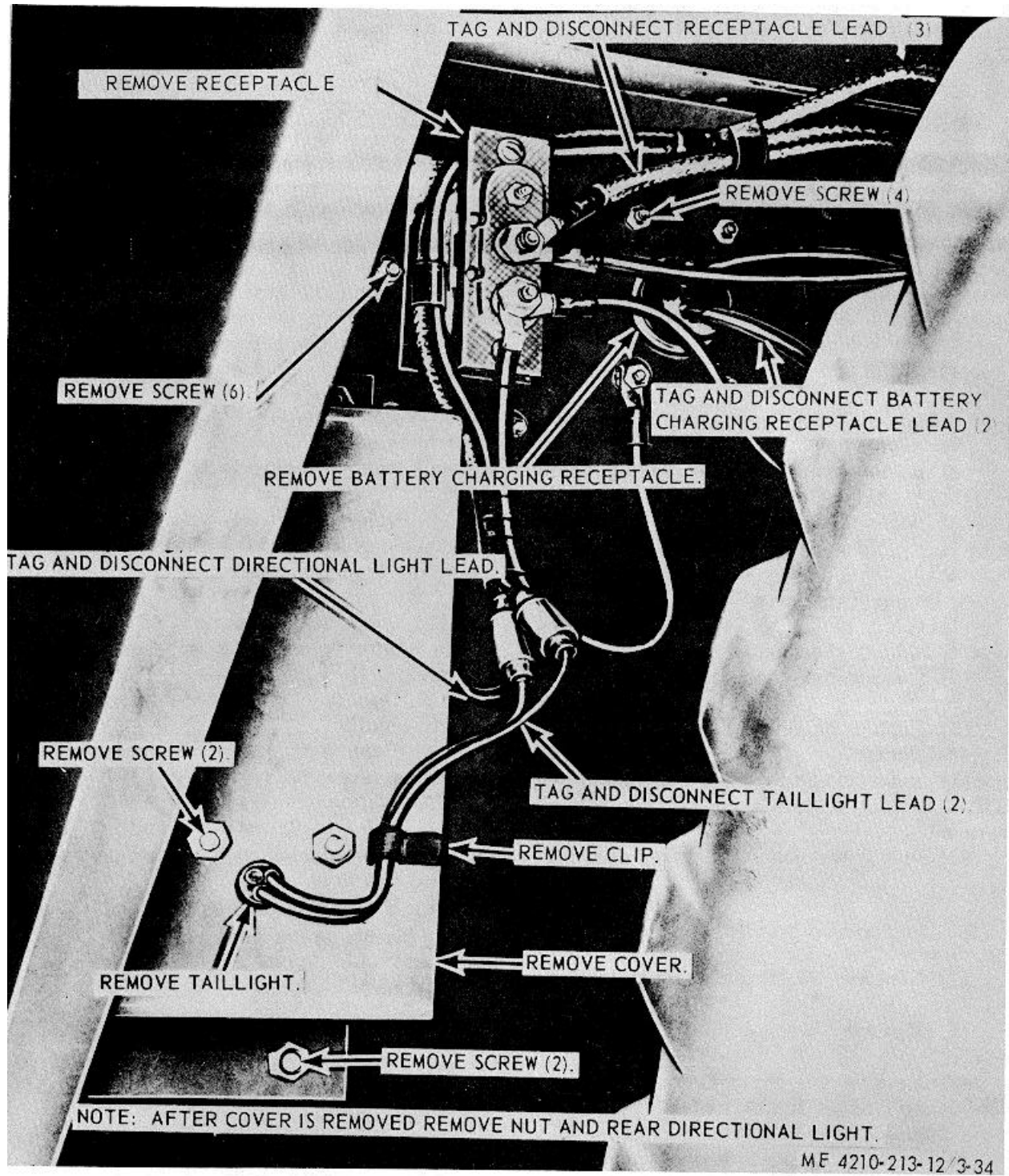

Figure 3-34. Rear directional light and taillight, removal and installation.

Section XII. CONTROLS, INSTRUMENTS AND PANELS

3-77. General

The controls and instruments are primarily located on the operators instrument panels located on the left and right sides of the fire truck below the hose reel compartments. The pump gage panel is located near the left hand instrument panel. It houses the tachometer-hour meter which registers the engine rpm and hours of operation. The pump discharges pressure gage determines the water discharge pressure, and hydrant pressure. Throttle controls located on the left instrument panel operate the engine speed. The apron is mounted on the special purpose body at the rear of the fire truck. There is a pump compartment bottom panel located below and mounted on the pump compartment frame.

3-78. Right Side Control Panel

a. Removal.

- (1) Remove the hose reel switch (para 3-67).
- (2) Refer to figure 3-35, and remove the right side control panel from the pump compartment.

b. Cleaning, Inspection, and Repair.

- (1) Clean with an approved cleaning solvent, and dry thoroughly.
- (2) Inspect for damaged or defective condition.
- (3) Replace or repair as necessary.

c. Installation.

- (1) Refer to figure 3-35, and install the right side control panels on the pump compartment.
- (2) Install the hose reel switch (para 65).

3-79. Left Side Control Panel

a. Removal.

- (1) Remove the throttle control (para 3-45).
- (2) Remove the hose reel switch (para 3-67).
- (3) Remove the engine dome and pump gage control panel lights switch (para 3-65 and 3-66).
- (4) Refer to figure 3-36, and remove the left side control panel and bottom panel from the pump compartment.

b. Cleaning, Inspection, and Repair.

- (1) Clean with an approved cleaning solvent, and dry thoroughly.
- (2) Inspect for damaged or defective condition.
- (3) Replace or repair as necessary.

c. Installation.

- (1) Refer to figure 3-36, and install the left side control panel and bottom panel on the pump compartment.
- (2) Install the engine, dome and pump gage control panel light switch (para 3-65 and 3-66).
- (3) Install the hose reel switch (para 3-67).
- (4) Install the throttle control (para 3-45).

3-80. Tachometer-Hourmeter

a. Removal.

- (1) Refer k, figure 3-29, and remove the cover.
- (2) Refer k, figure 3-37, and remove the tachometer-hour meter from the pump gage panel and transfer case.

b. Cleaning, Inspection, and Repair.

- (1) Clean with a clean cloth dampened in an approved cleaning solvent, and dry thoroughly.
- (2) Inspect all parts for damaged or defective condition.
- (3) Replace or repair damaged or defective parts as necessary.

c. Installation.

- (1) Refer to figure 3-37, and install the tachometer-hour meter on the pump gage panel and transfer case.
- (2) Refer to figure 3-29, and install cover. 3-

81. Discharge Pressure Gage

a. Removal.

- (1) Refer to figure 3-29, and remove the cover.
- (2) Refer to figure 3-27, and remove the discharge pressure gage from the pump gage panel.

b. Inspection, and Repair.

- (1) Inspect for damaged or defective condition.
- (2) Replace or repair damaged or defective parts as necessary.

c. Installation.

- (1) Refer to figure 3-37, and install the discharge pressure gage on the pump gage panel.
- (2) Refer to figure 3-29, and install the cover.

3-82. Vacuum and Hydrant Pressure Gage

a. Removal.

- (1) Refer to figure 3-29, and remove the cover.
- (2) Refer to figure 3-37, and remove the hydrant pressure gage from the pump gage panel.

b. Cleaning, Inspection, and Repair.

- (1) Clean with an approved cleaning solvent, and dry thoroughly.
- (2) Inspect all parts for damaged or defective condition.
- (3) Replace or repair damaged or defective parts as necessary.

c. Installation.

- (1) Refer to figure 3-37, and install the vacuum hydrant pressure gage on the pump gage panel.
- (2) Refer to figure 3-29, and install the cover.

3-83. Pump Gage Control Panel

a. Removal.

- (1) Remove the tachometer-hour meter (para 3-80).
- (2) Remove the vacuum hydrant pressure gage (para 3-82).
- (3) Discharge pressure gage (para 3-81).
- (4) Refer to figure 3-7, and remove the pump gage control panel from the special purpose body.

b. Cleaning, Inspection, and Repair.

- (1) Clean with an approved cleaning solvent, and dry thoroughly.
- (2) Inspect for damaged or defective condition.
- (3) Replace or repair as necessary.

c. Installation.

- (1) Refer to figure 3-37, and install the pump gage panel on the special purpose body.
- (2) Install the discharge pressure gage (para 3-81).
- (3) Install the hydrant pressure gage (para 3-82).

- (4) Install the tachometer-hour meter (para 3-0).

3-84. Apron

a. Removal.

- (1) Remove the rear step (para 3-30).
- (2) Remove the hose retainers (para 3-33 and 3-34).
- (3) Remove the receptacles (para 3-75).
- (4) Remove the shovel bracket (para 3-31).
- (5) Remove the folding step (para 3-35).
- (6) Refer to figure 3-38, and remove the apron from the special purpose body.

b. Cleaning, Inspection, and Repair.

- (1) Clean with a clean cloth dampened in an approved cleaning solvent, and dry thoroughly.
- (2) Inspect for damaged or defective condition.
- (3) Replace or repair as necessary.

c. Installation.

- (1) Refer to figure 3-38, and install the apron on the special purpose body.
- (2) Install the folding step (para 3-35).
- (3) Install the shovel bracket (para 3-31).
- (4) Install the receptacles (para 3-75).
- (5) Install the hose retainers (para 3-33 and 3-45).
- (6) Install the rear step (para 3-30).

3-85. Pump Compartment Panel

- a. Removal.* Refer to figure 3-39, and remove the pump compartment panel from the pump compartment.

b. Cleaning, Inspection, and Repair.

- (1) Clean with an approved cleaning solvent, and dry thoroughly.
- (2) Inspect damaged or defective condition.
- (3) Replace or repair as necessary.

- c. Installation.* Refer to figure 3-39, and install the pump compartment panel on the pump compartment.

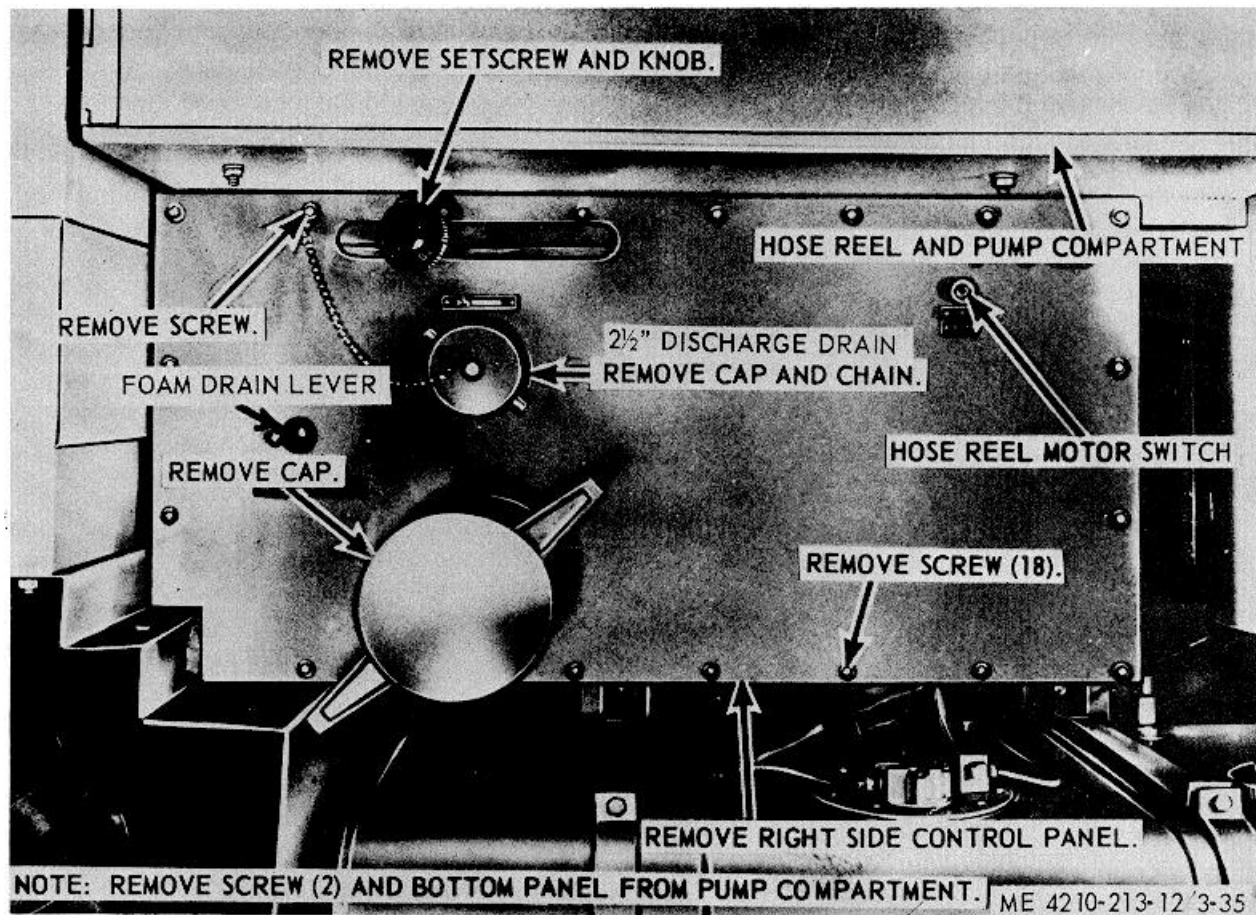

Figure 3-35. Right side control panel, removal and installation.

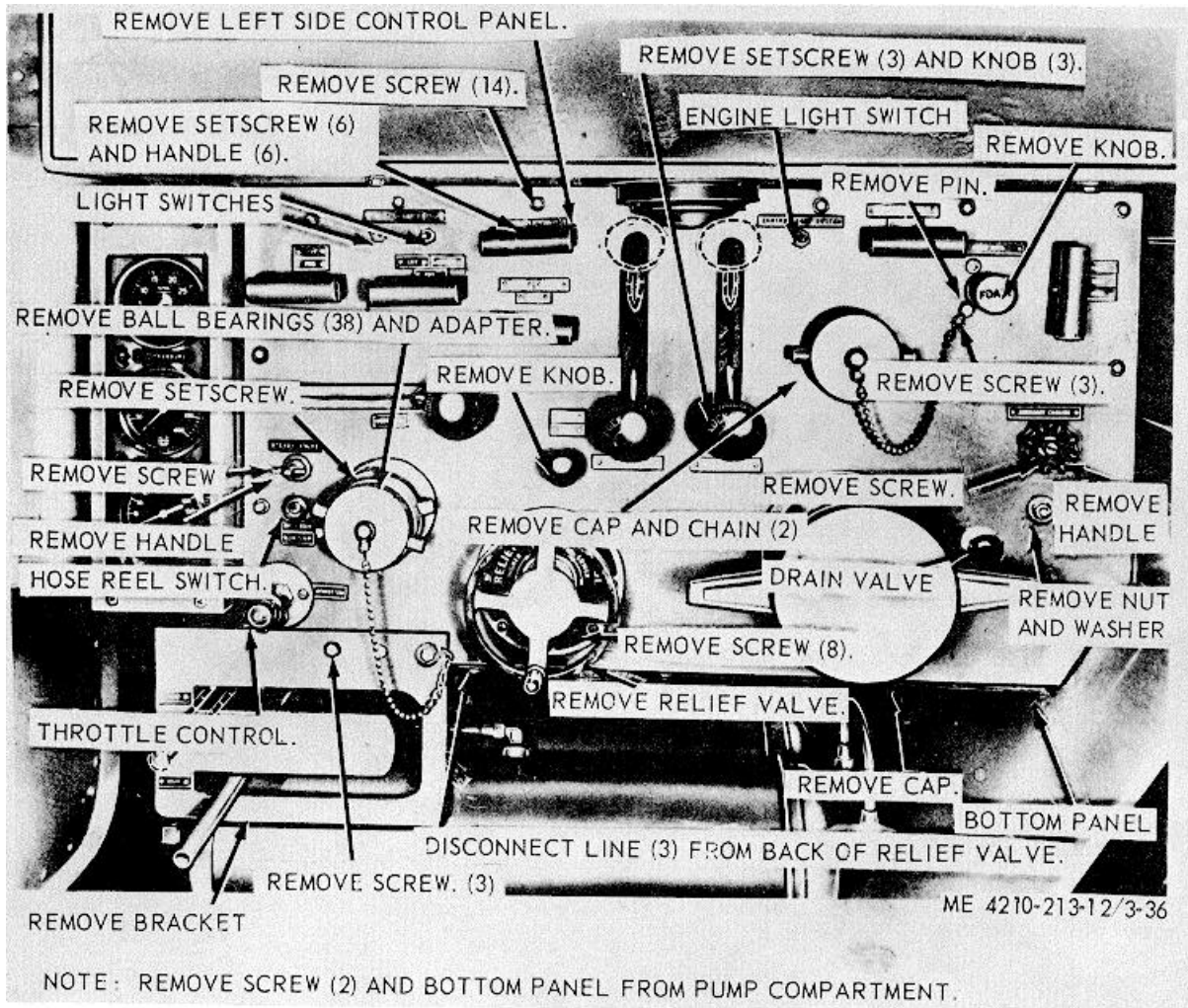

Figure 3-86. Left side control panels, removal and installation.

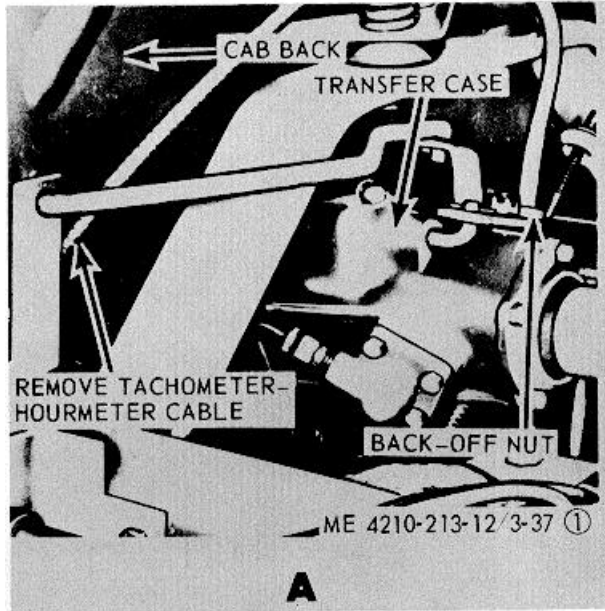

Figure 3-37. Compartment accessory door, battery box and oil pan heater adapter.

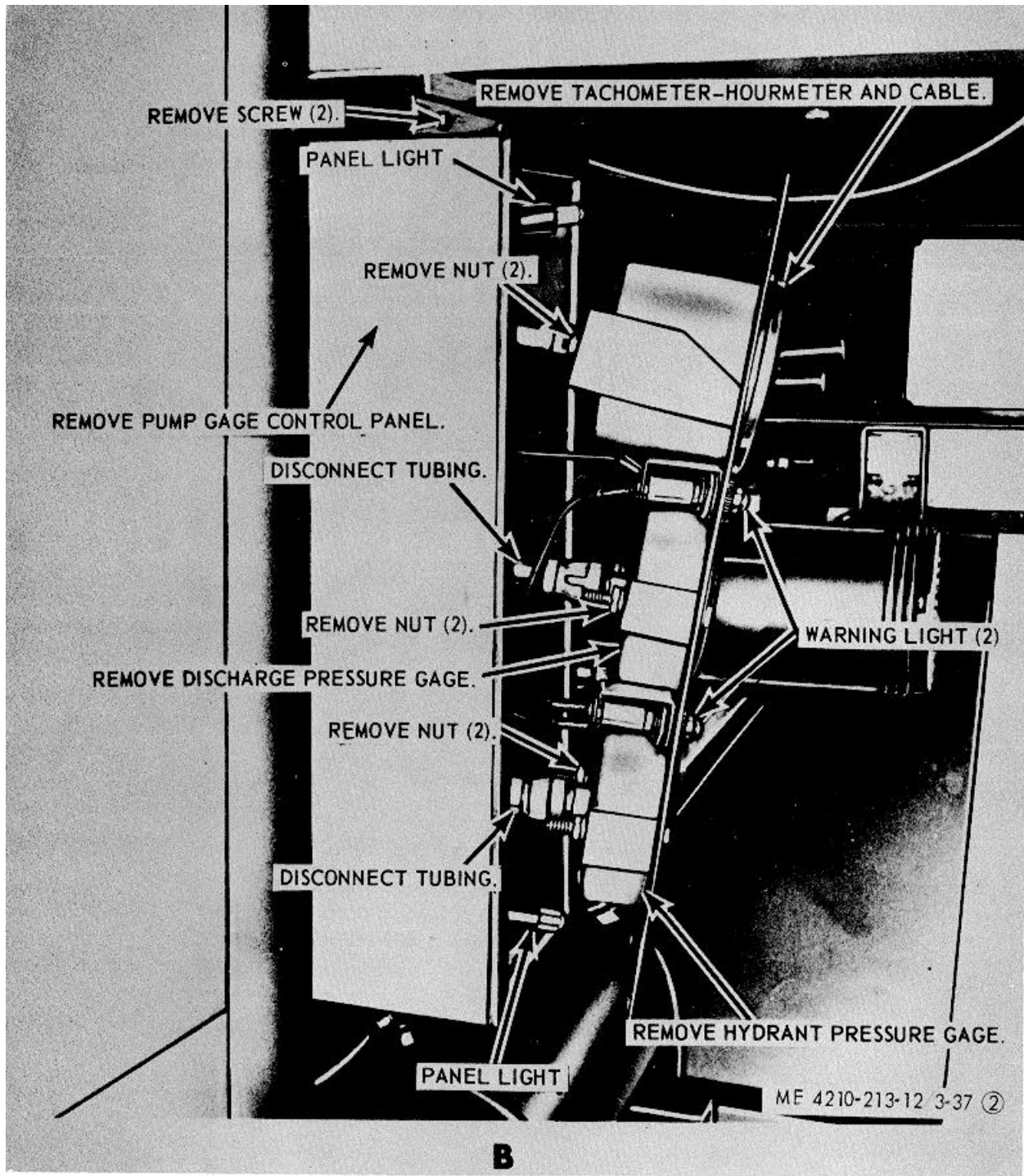

Figure 3-37. Continued.

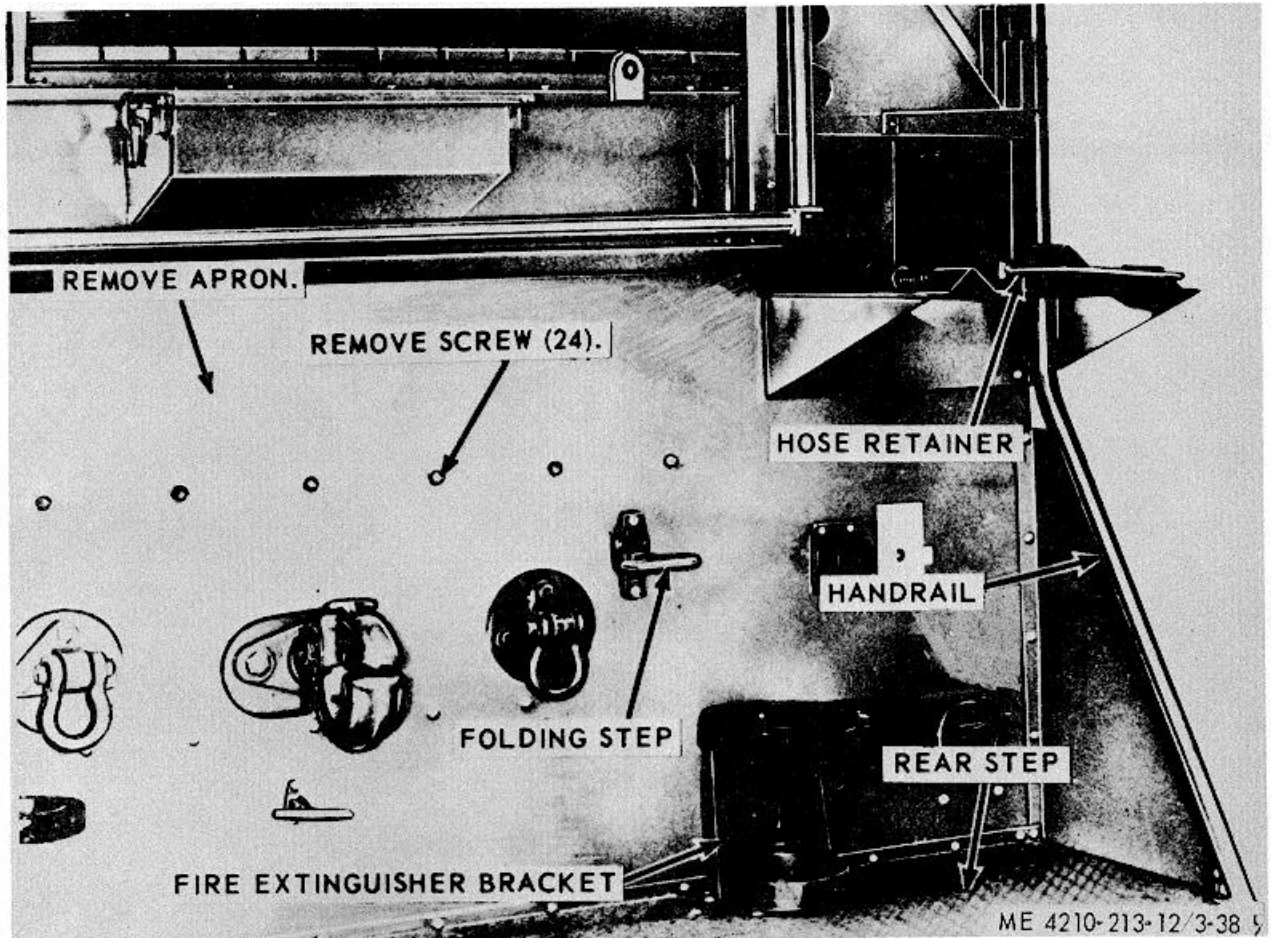

Figure 3-38. Apron, removal and installation.

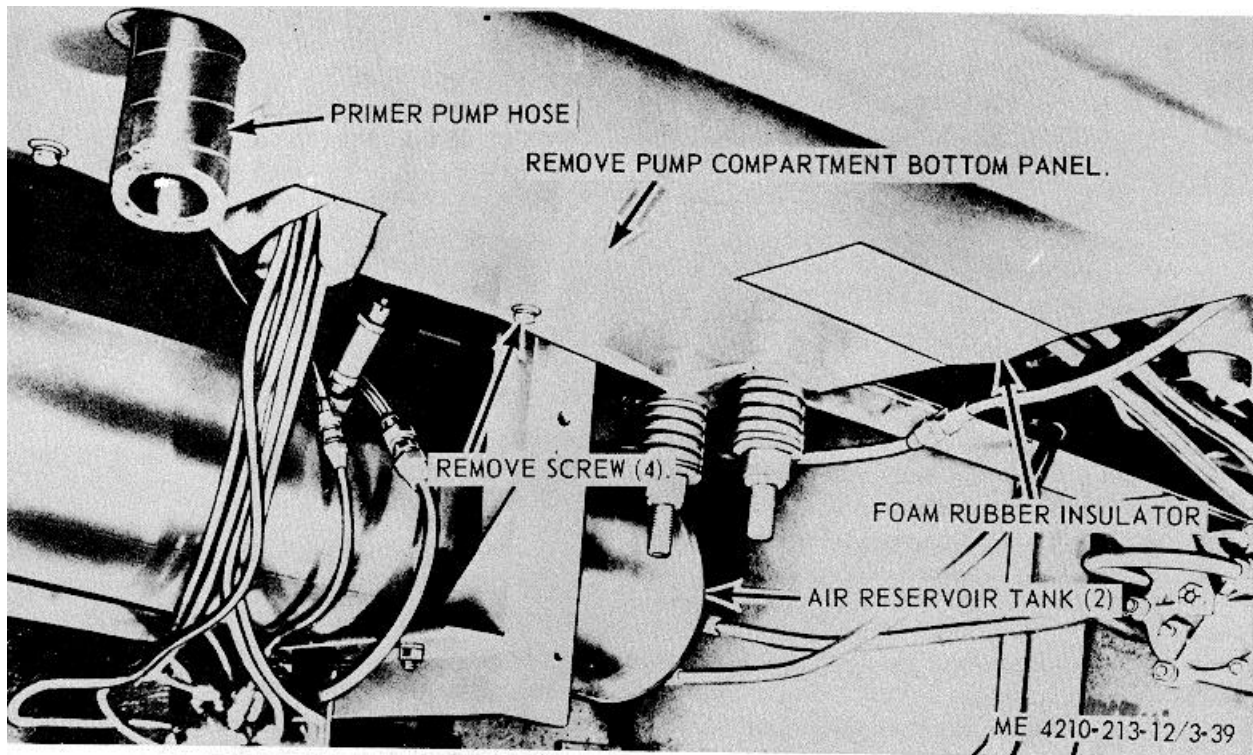

Figure 3-39. Pump compartment panel, removal and installation.

Section XIII. PUMPING SYSTEM

3-86. General

The fire truck pumping system consists of a centrifugal type pump rotary vacuum priming pump, steady valve, relief valve; water tank, foam and two motor driven hose reels. A series of operating valves, drain valve, and a foam metering valve. Regulate operation of the fire pump for pumping water, or a water and foam combination. The centrifugal type pump develops pressure and capacity, by means of centrifugal force, and must be primed before it will lift water. The priming system consists of a rotary vacuum pump operated by a 24-volt electric motor controlled through a manual priming valve which activates a microswitch controlling the electric motor. Water pressure is controlled manually by a throttle knob and is held automatically by a relief valve. The relief valve is adjusted to any pump pressure up to 300 psi. The hose reels are electric motor driven, and actuated by a reel rewind button, located beneath the hose reel assemblies on the instrument panel. The heat exchanger is mounted in the engine

compartment, and circulates water through the engine cooling system from the pumping system to cool the engine. The primer oil tank is mounted on the engine cab beneath the right hand seat. It supplies oil to the primer pump.

3-87. Primer Pump

a. Removal.

(1) Remove the primer pump motor and solenoid relay (para 3-71).

(2) Refer to figure 3-40, and remove and replace defective primer pump from the fire pump manifold.

b. *Installation.* Install the primer pump motor and solenoid relay (para 3-71).

3-88. Hose Reel

a. Removal.

(1) Remove the hose reel motor solenoid (para 3-68).

(2) Remove the hose reel motor (para 3-69) -

(3) Refer to figure 3-41, and remove the

hose reel from the hose reel and pump compartment.

b. Installation.

- (1) Refer to figure 3-41, and install the hose reel in the hose reel pump compartment.
- (2) Install the hose reel motor (para 3-69).
- (3) Install the hose reel motor solenoid (para 3-68).

3-89. Drive Chain

a. Removal. Refer to figure 3-31, and remove the drive chain from the hose reel and motor.

b. Cleaning, Inspection, and Repair.

- (1) Clean all parts with a clean cloth dampened in an approved cleaning solvent, and dry thoroughly.
- (2) Inspect for damaged or defective condition.
- (3) Replace or repair damaged or defective parts as necessary.

c. Installation. Refer to figure 3-31, and install the drive chain on the hose reel and motor.

3-90. Pump Clutch Linkage

a. Removal.

- (1) Remove the tool box (TM 9-2320-209-20).
- (2) Refer to figure 3-43, and remove the pump clutch linkage from the clutch and transfer case.

b. Disassembly. Refer to figure 3-44, and disassemble the pump clutch linkage.

c. Cleaning, Inspection, and Repair.

- (1) Clean all parts with a clean cloth dampened in an approved cleaning solvent, and dry thoroughly.
- (2) Inspect all parts for damaged or defective condition.
- (3) Replace or repair damaged or defective parts.

d. Reassembly. Refer to figure 3-44, and install the pump clutch linkage on the clutch and transfer case.

e. Adjustment.

- (1) Refer to figure 3-43, and adjust the pump clutch linkage.
- (2) Install the tool box (TM 9-2320-209-20).

3-91. Foam Tank Strainer, Foam Tank and Vent Hose

a. Removal.

- (1) Drain the foam tank (para 2-15).

(2) Refer to figure 3-45, and remove the foam tank and vent hose from the compartment.

b. Cleaning, Inspection, and Repair.

(1) Clean all parts with a clean cloth dampened in an approved cleaning solvent, and dry thoroughly.

(2) Inspect all parts for damaged or defective condition.

(3) Replace or repair damaged or defective parts as necessary.

c. Installation.

(1) Refer to figure 3-45, and install the foam tank and vent hose on the compartment.

(2) Fill foam tank (para 2-13).

(3)

3-9. Pump Drive Universal Joint

a. Removal. Refer to figure 3-40, and remove the pump drive universal joint from the pump and transfer case.

b. Disassembly. Refer to figure 3-47, and disassemble the pump drive universal joint.

c. Cleaning, Inspection, and Repair.

(1) Clean all parts with a clean cloth dampened in an approved cleaning solvent and dry thoroughly.

(2) Inspect all parts for damaged or defective condition.

(3) Replace or repair damaged or defective parts.

d. Reassembly. Refer to figure 3-47, and reassemble the pump drive universal joint in the reverse order.

e. Installation. Refer to figure 3-40, and install the pump drive universal joint on the pump and transfer case.

3-93. Drain Valve and Tubing

a. Removal.

- (1) Drain the lines (para 2-15).
- (2) Refer to figure 3-48, and remove the drain valve and tubing from the valves, lines and bracket.

b. Cleaning, Inspection and Repair.

(1) Clean all parts with a clean cloth dampened in an approved cleaning solvent, and dry thoroughly.

(2) Inspect for damaged or defective condition.

(3) Replace or repair damage or defective parts as necessary.

c. *Installation.* Refer to figure 3-48, and install the drain valve and tubing on the valves, lines, and bracket.

3-94. Heat Exchanger, Tubing, Hoses, Clamps, and Fittings Refer to figure 3-49, and remove and replace defective heat exchanger, tubing, hoses, clamps, and fittings.

3-95. Relief Valve Control

a. *Removal.* Refer to figure 3-36, and remove the relief valve control from the left side control panel.

b. *Cleaning, Inspections, and Repair.*

(1) Clean all parts with an approved cleaning solvent, and dry thoroughly.

(2) Inspect for damaged or defective condition.

(3) Replace or repair damaged or defective parts as necessary.

c. *Installation.* Refer to figure 3-36, and install the relief valve control on the left side control panel.

3-96. Water Pump Packing

Refer to figure 3-50, and adjust the fire pump packing.

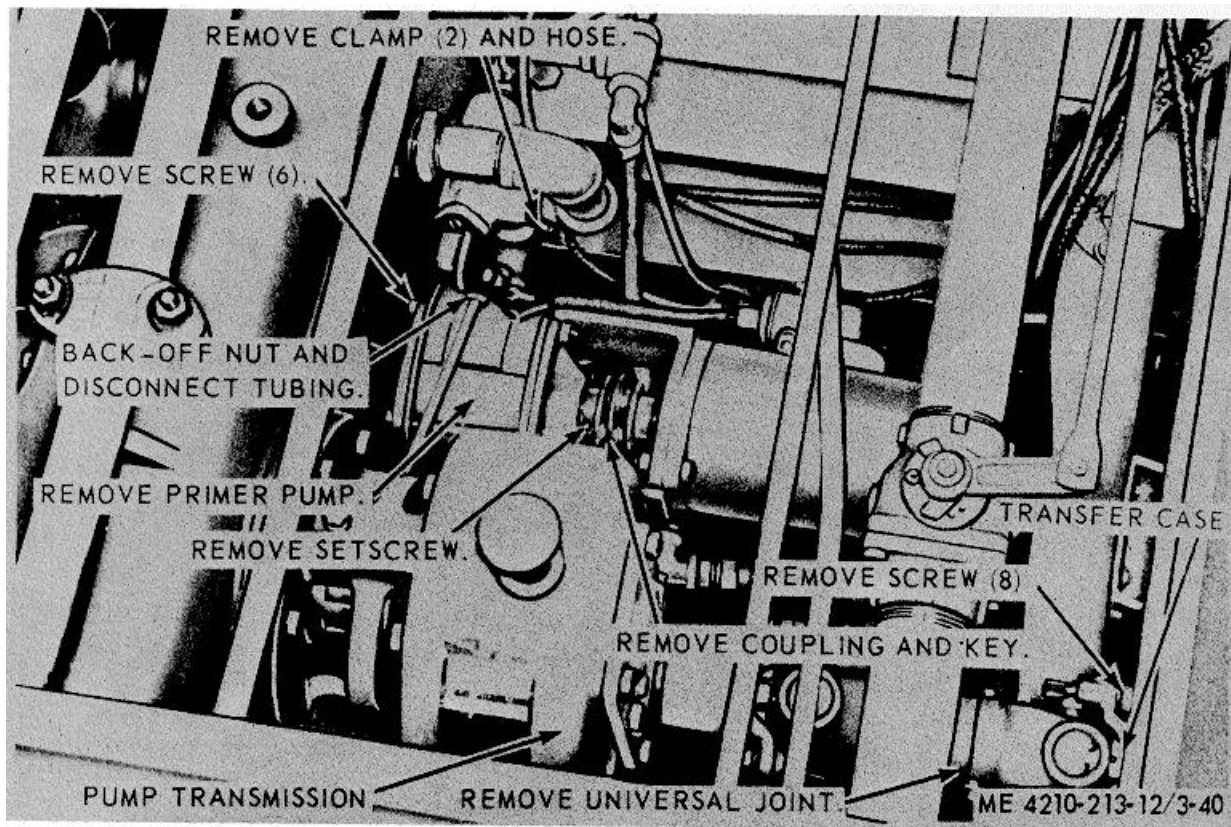
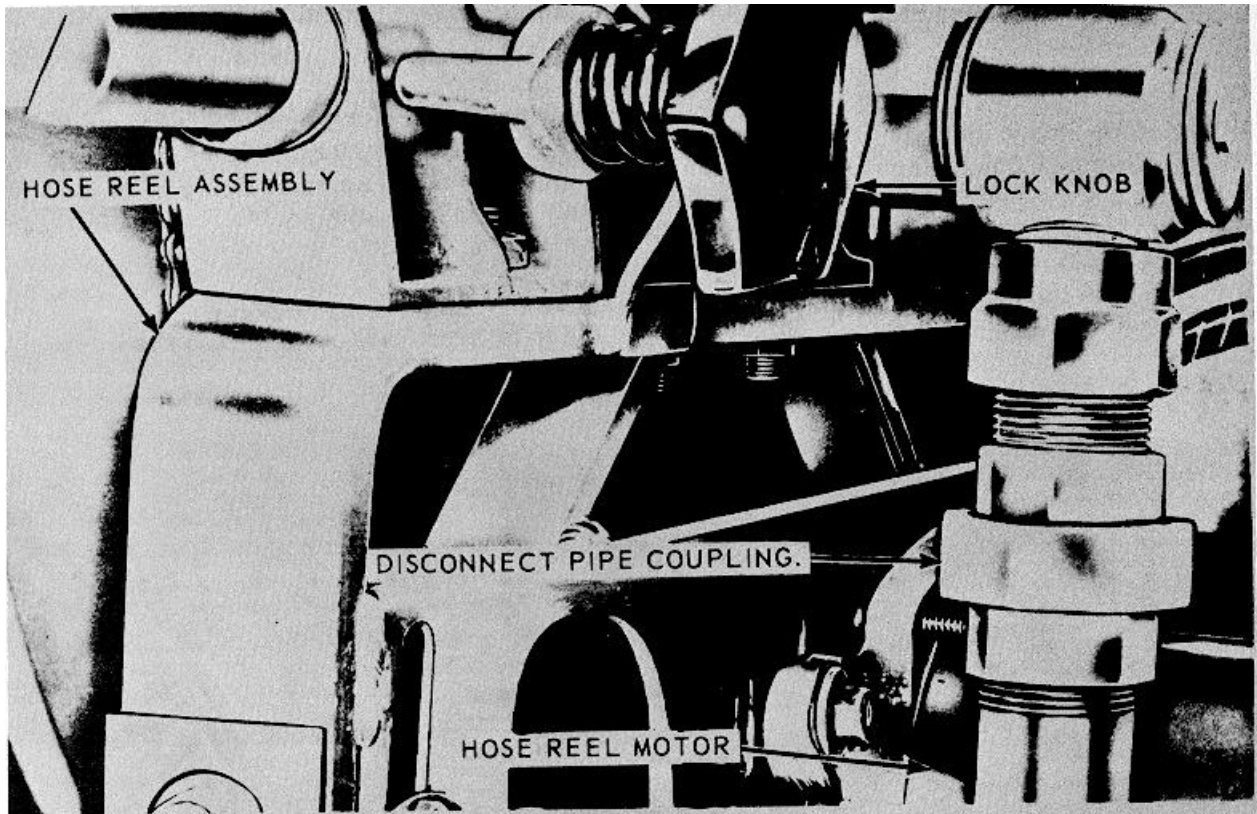
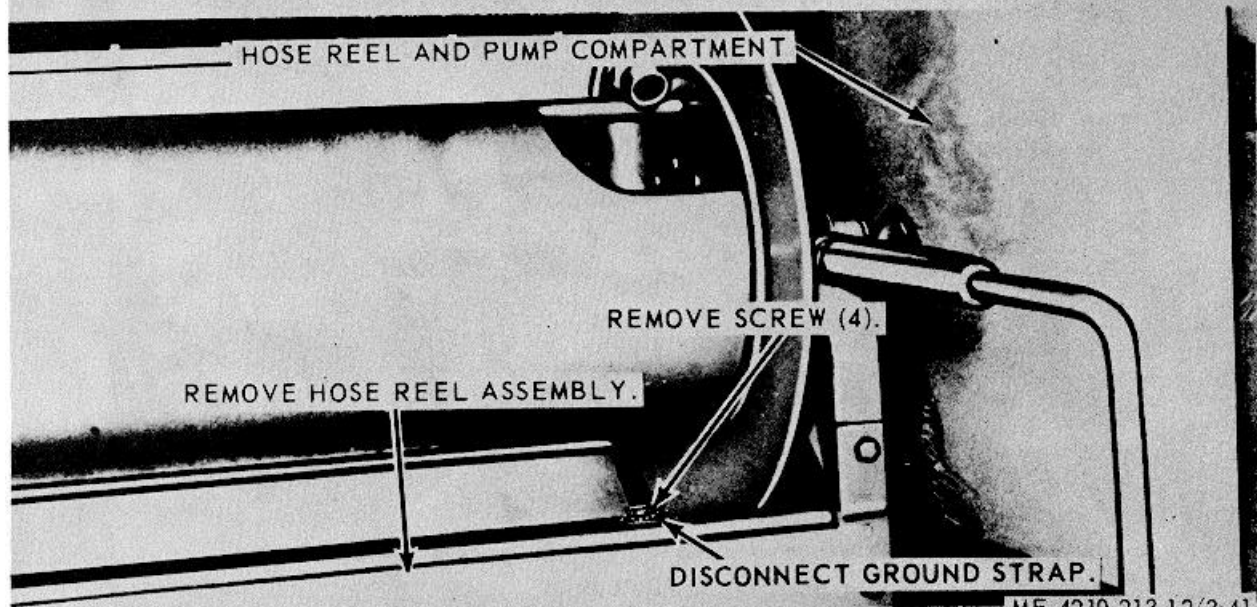

Figure 3-40. Primer pump and universal joint, removal and installation.



A



B

ME 4210-213-12/3-41

Figure 3-41. Hose reel, removal and installation.

Figure 3-42. Not used.

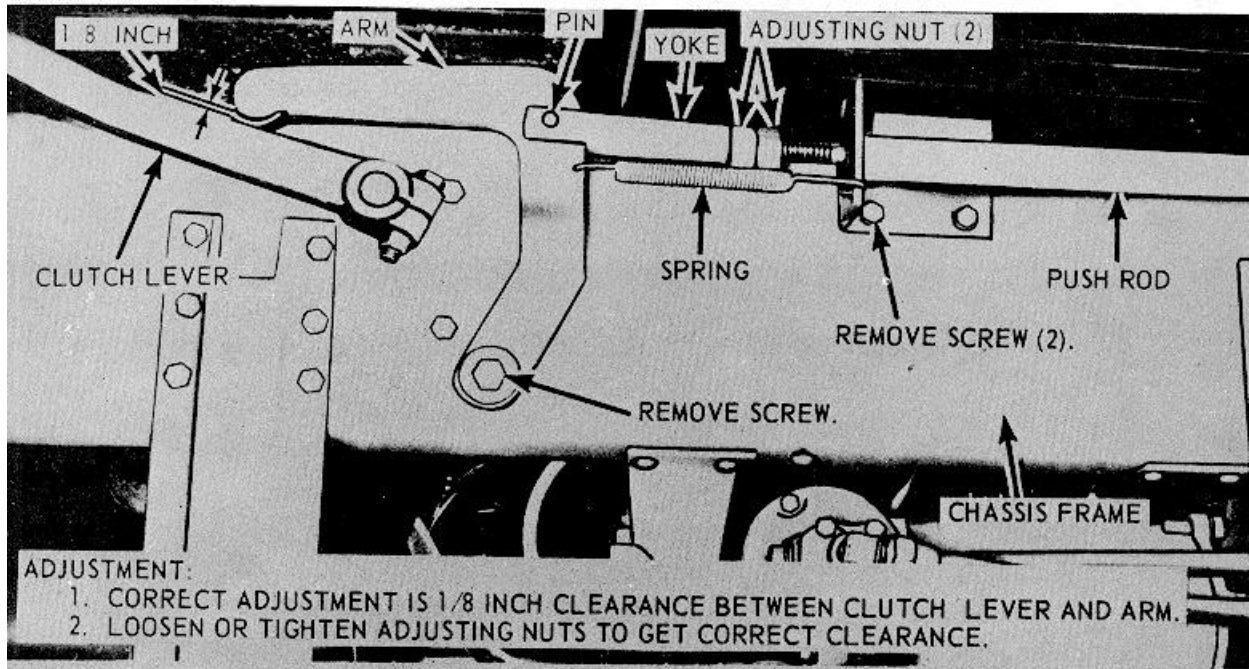

A

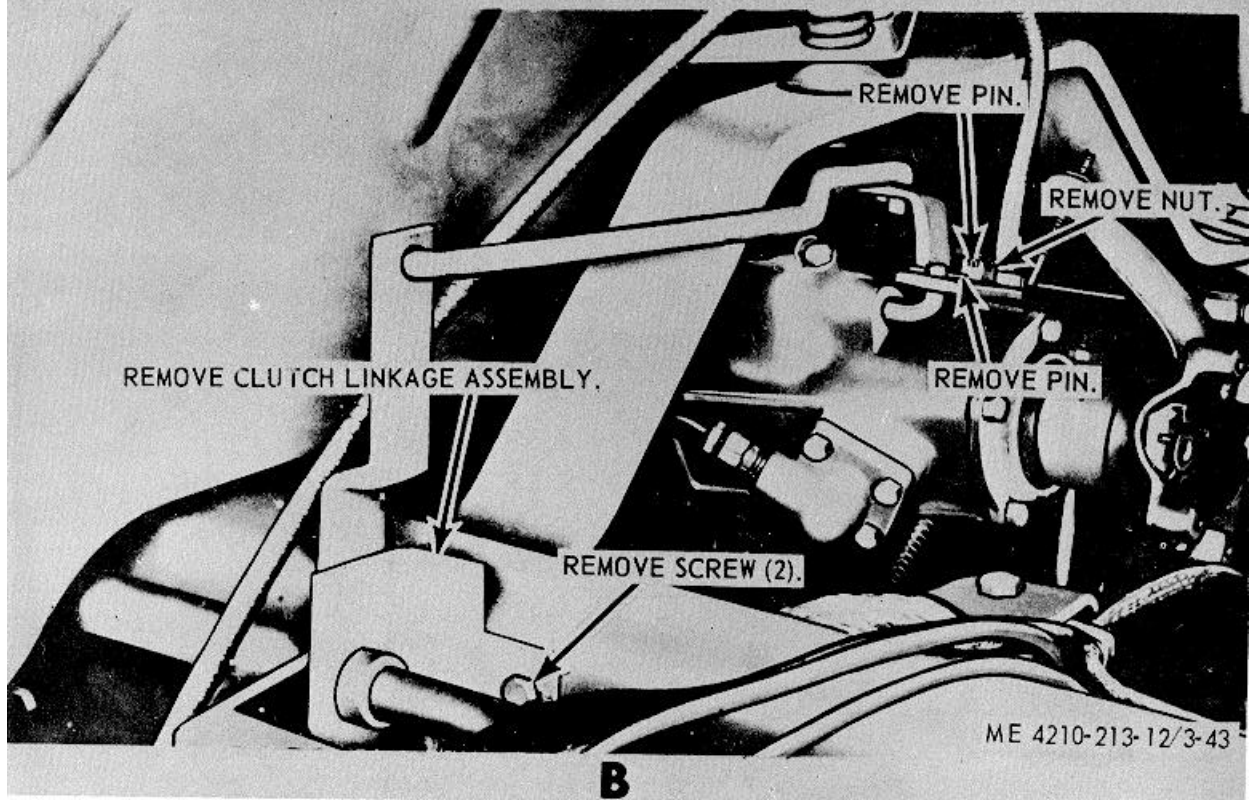

B

Figure 3-43. Pump clutch linkage, removal, installation, and adjustment.

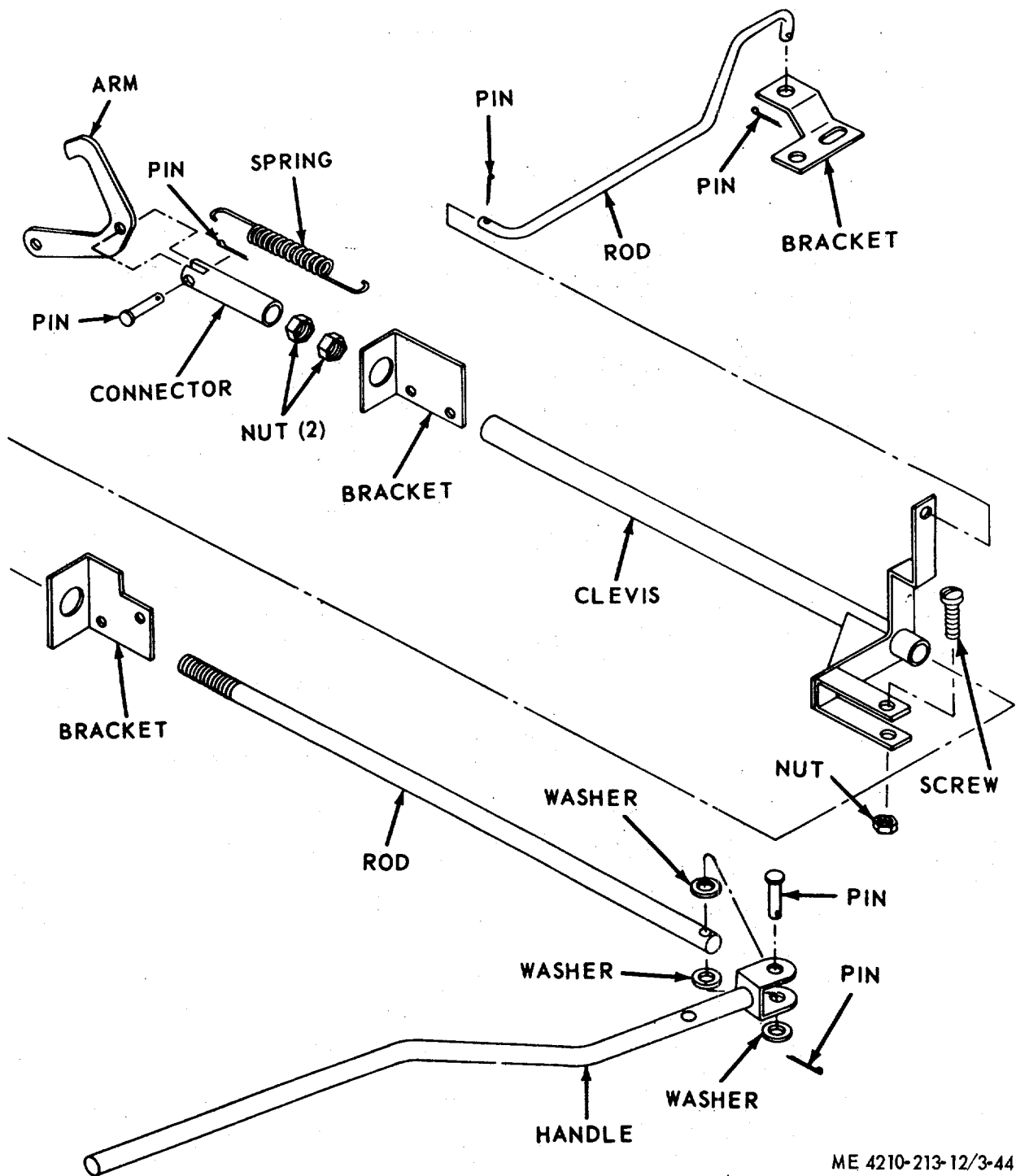

ME 4210-213-12/3-44

Figure 3-44. Pump clutch linkage, exploded view.

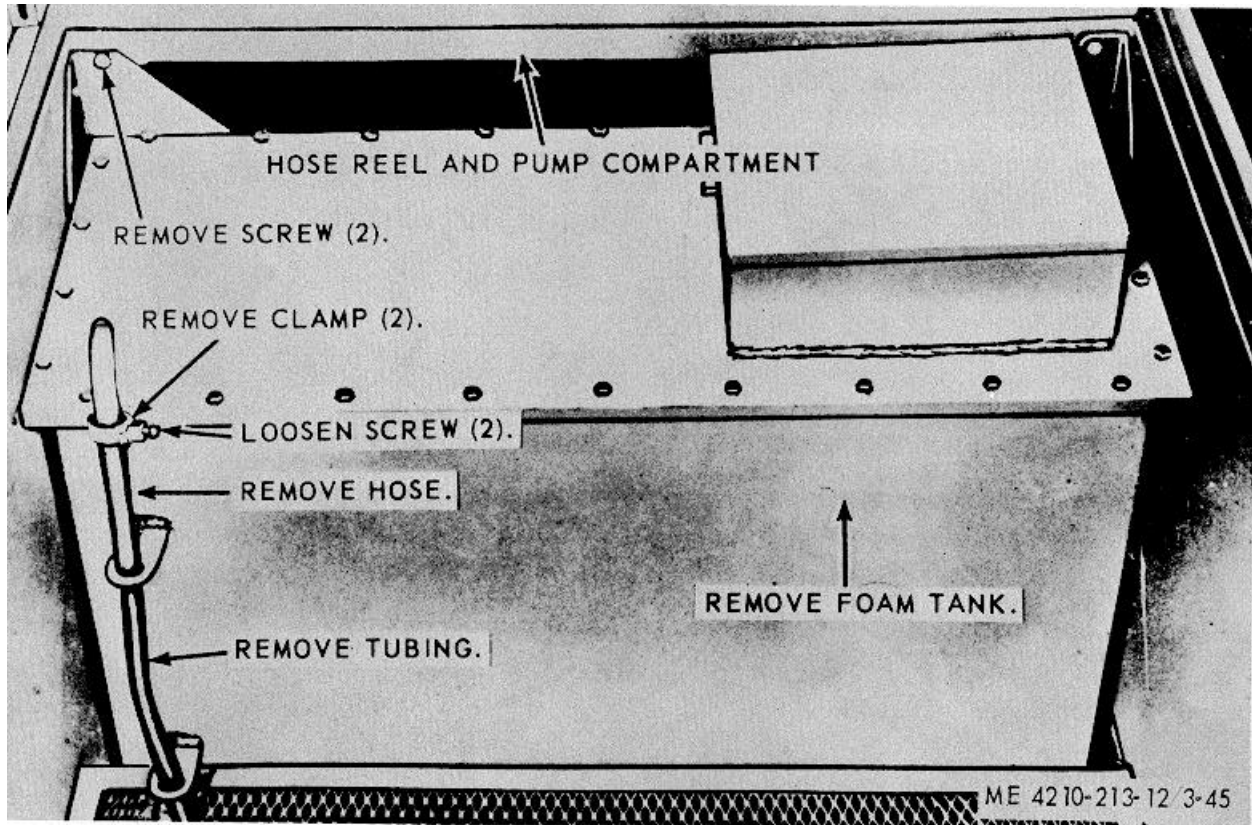
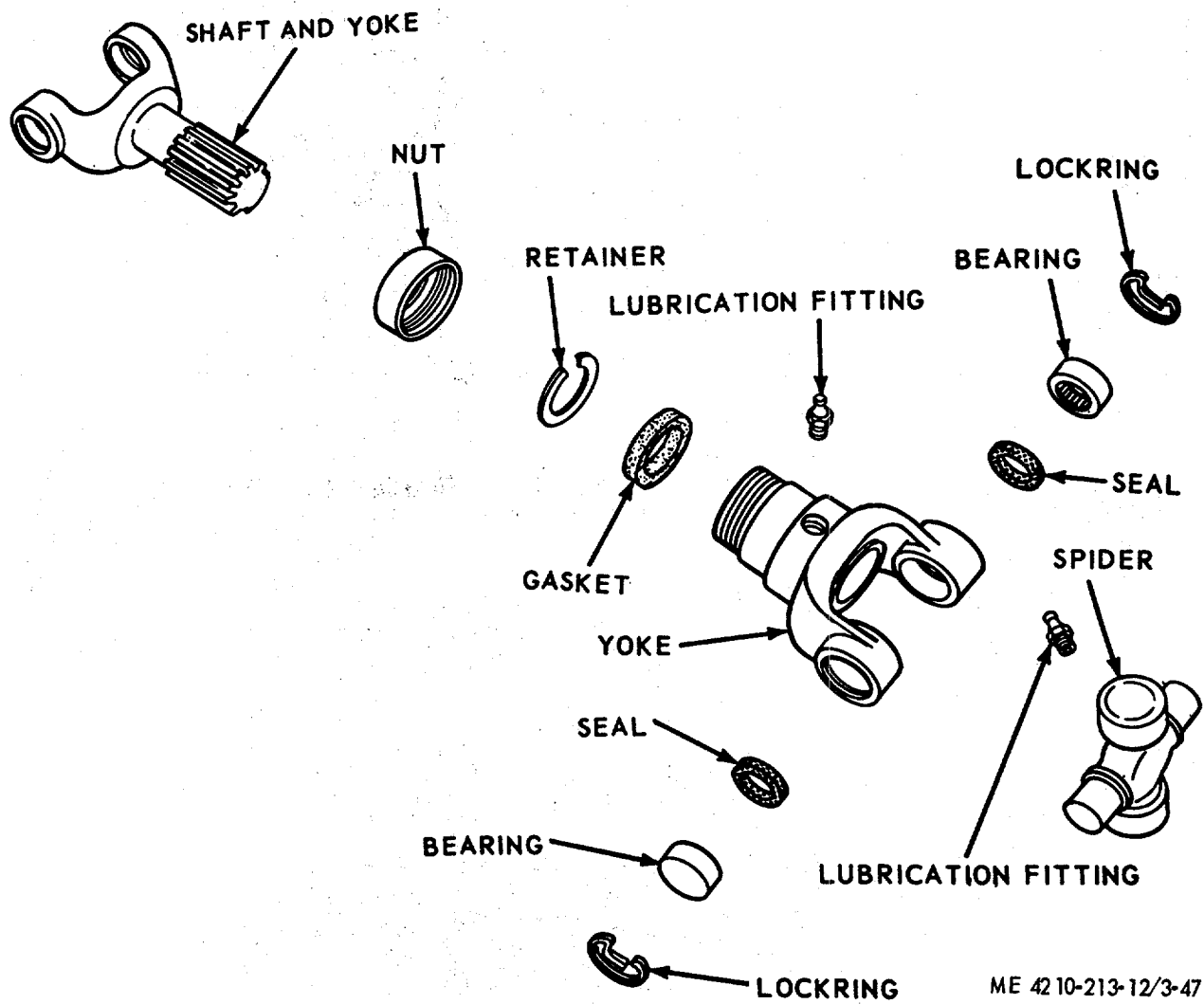

Figure 3-45. Foam tank, vent hose, and foam tank, removal and installation

Figure 3-46. Not used.



ME 4210-213-12/3-47

Figure 3-47. Pump drive universal joint, exploded view.

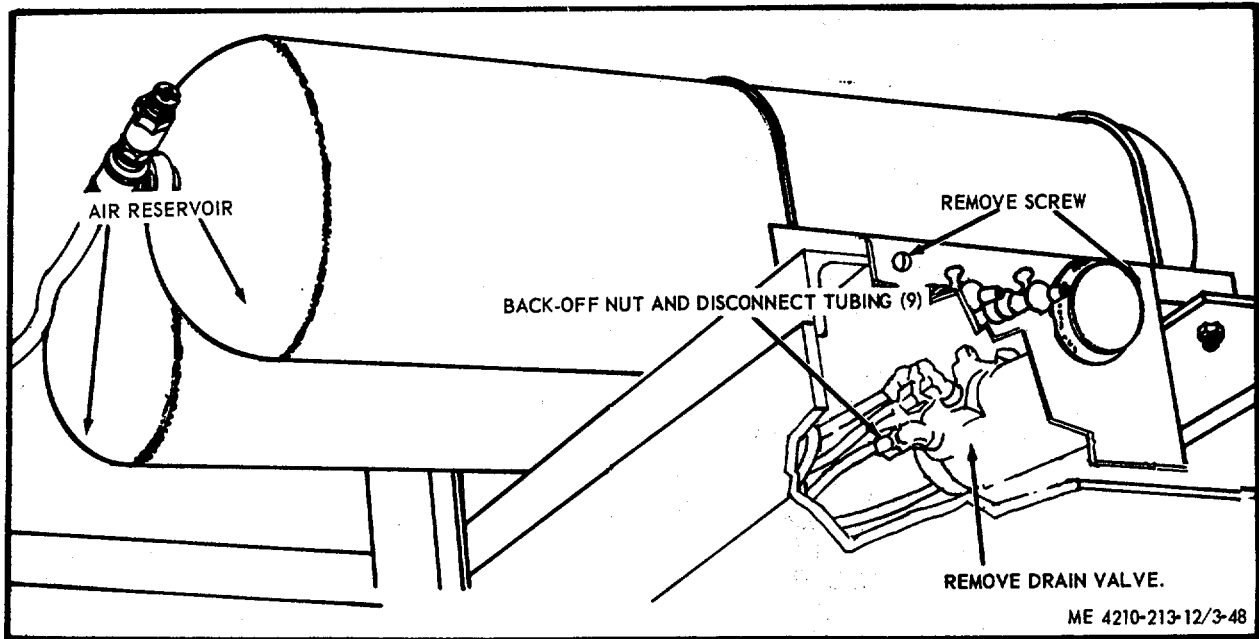

Figure 3-48. Drain valve and tubing, removal and installation.

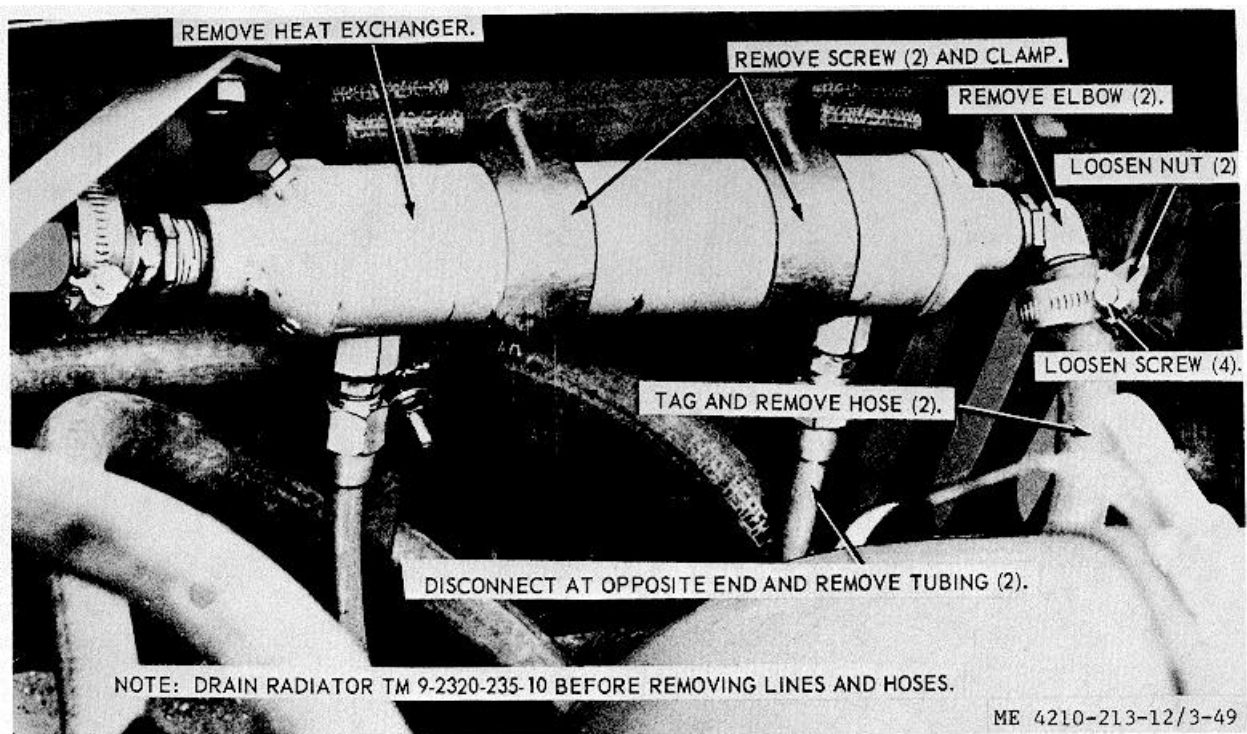

Figure 3-49. Heat exchanger and tubing, removal and installation.

ADJUSTMENT

1. MAKE SURE SLEEVE SCREW IS TIGHT.
2. LOOSEN PACKING GLAND SCREW.
3. TURN PACKING GLAND NUT CLOCKWISE TO TIGHTEN COUNTERCLOCKWISE TO LOOSEN PACKING.
4. TIGHTEN PACKING GLAND SCREW AND LOCK IN PLACE WITH LOCKNUT.

NOTE: ADJUSTMENT IS NECESSARY ONLY WHEN AIR LEAKS IN WHEN WORKING FROM DRAFT OR WATER LEAKS OUT WHEN WORKING FROM HYDRANT.

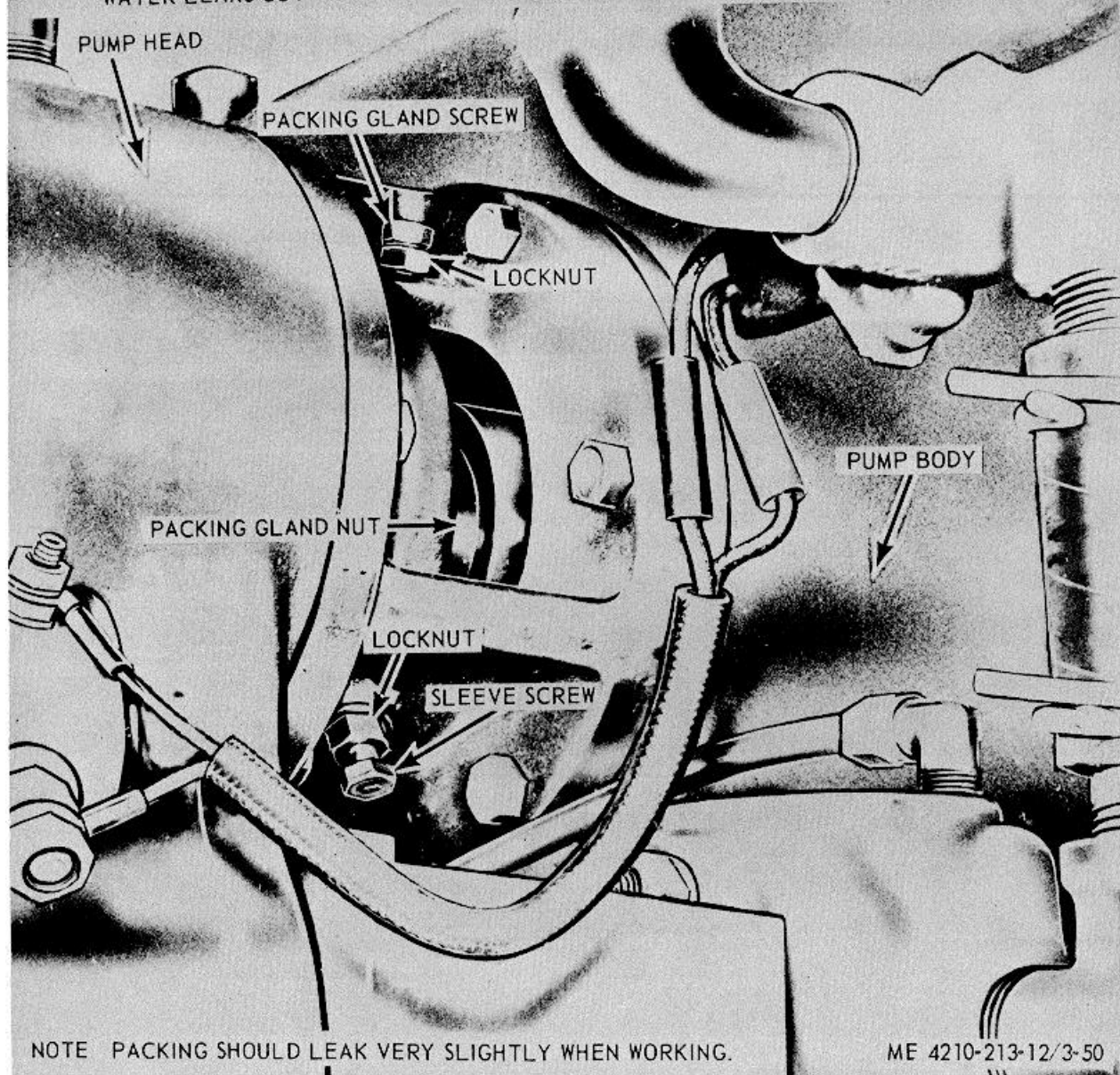

Figure 3-50. Water pump packing adjustment.

Section XIV. VEHICULAR COMPARTMENT HEATER

3-97. General

The vehicular compartment heater receives heated coolant from the engine circulating system and passes it through a core where the heat is transferred to air forced through by the circulating fans and directed to the defrosting system, the interior of the personnel compartment or both at the option of the operator. Speed controls located on the instrument panel allow a selection of speeds for the defroster blower and compartment fan.

3-98. Vehicular Compartment Heater

a. Removal.

- (1) Drain coolant (TM 9-2320-209-10).
- (2) Loosen hose clamps on the heater hose connections at bottom of heater.
- (3) Remove hoses from heater connections.
- (4) Disconnect four wires leading to heater.
- (5) Remove four bolts, nuts and lockwashers holding heater to fire wall and remove heater.

b. *Disassembly.* Disassemble the compartment heater as shown in (fig. 3-51).

c. *Cleaning, Inspection and Repair.*

- (1) Clean all parts with an approved cleaning solvent and dry thoroughly.
- (2) Inspect parts for damage or defective condition.
- (3) Replace or repair damaged parts as necessary.

d. *Reassembly.* Reassemble the compartment heater as shown in (fig. 3-51).

e. *Installation.*

- (1) Place heater in position against firewall.
- (2) Install four bolts, nuts and lockwashers holding heater to firewall and install heater.
- (3) Connect four wires leading to heater.
- (4) Install hoses from heater connections.
- (5) Tighten hose clamps on heater hose connections at bottom of heater.
- (6) Fill coolant (TM 9-2320-209-10).

Section XV. LUBRICATION SYSTEM

3-99. General

The lubrication system consists of an oil tank and lines that supply lubrication to the vacuum priming pump.

3-100. Oil Tank and lines

a. Removal.

- (1) Disconnect the oil line at the priming pump (para 3-87).
- (2) Refer to figure 3-52, and remove the oil tank and lines from the cab and priming pump.

b. *Cleaning, Inspection, and Repair.*

(1) Clean all parts with a clean cloth dampened in an approved cleaning solvent, and dry thoroughly.

- (2) Inspect all parts for damaged or defective condition.
- (3) Replace or repair damaged or defective parts as necessary.

c. *Installation.*

- (1) Refer to figure 3-62, and install the oil tank and lines onto the cab and priming pump.
- (2) Connect the oil line at the priming pump para 3-87).

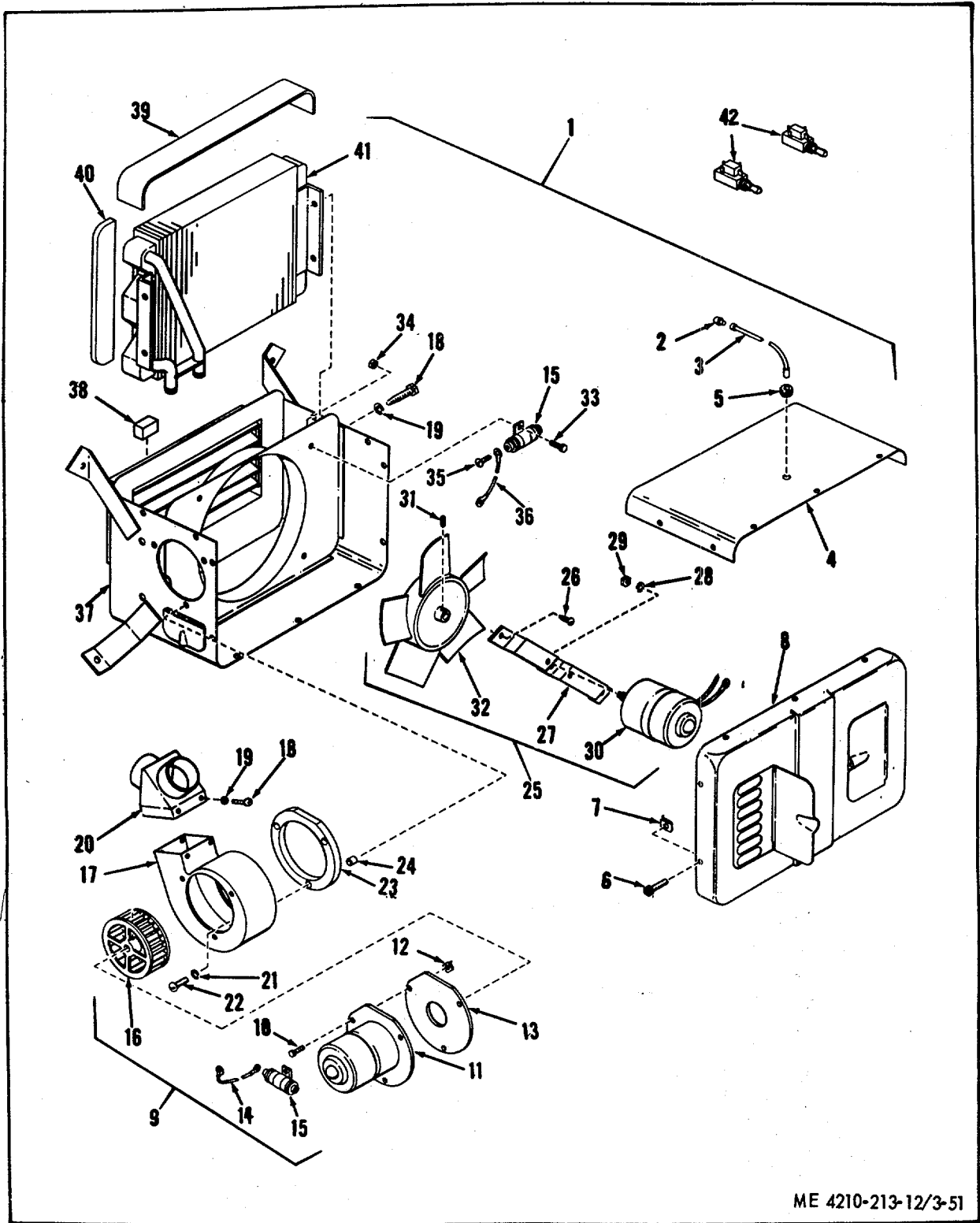

ME 4210-213-12/3-51

Figure 3-51. Vehicular compartment heater, exploded view.

- | | | |
|-------------------------------------|-----------------------------------|-------------------------------------|
| 1 Heater, vehicular compartment | 14 Lead electrical | 29 Nut assembly, washer |
| 2 Connector | 15 Suppressor | 30 Motor, D.C. |
| 3 Lead, electrical | 16 Wheel, blower | 31 Setscrew |
| 4 Panel top | 17 Housing, blower | 32 Fan |
| 5 Grommet | 18 Screw, tapping, thread cutting | 33 Screw assembly, washer |
| 6 Screw | 19 Washer, lock | 34 Nut assembly, washer |
| 7 Nut, stamped | 20 Defroster Y | 35 Screw assembly, washer |
| 8 Cover assembly, front | 21 Screw | 36 Lead, electrical |
| 9 Motor and wheel assembly, adapter | 22 Washer, lock | 37 Housing, heater |
| 10 Screw, cap, hex head | 23 Gasket, blower housing | 38 Block, shutter |
| 11 Motor, D.C. | 24 Spacer | 39 Spacer, core ends top and bottom |
| 12 Nut, stamped | 25 Motor and fan assembly, heater | 40 Spacer, core ends |
| 13 Gasket, motor mounting | 26 Screw assembly | 41 Core, heater |
| | 27 Bracket, motor mounting | 42 Switch, toggle |
| | 28 Washer, flat | |

Figure 3-51--Continued.

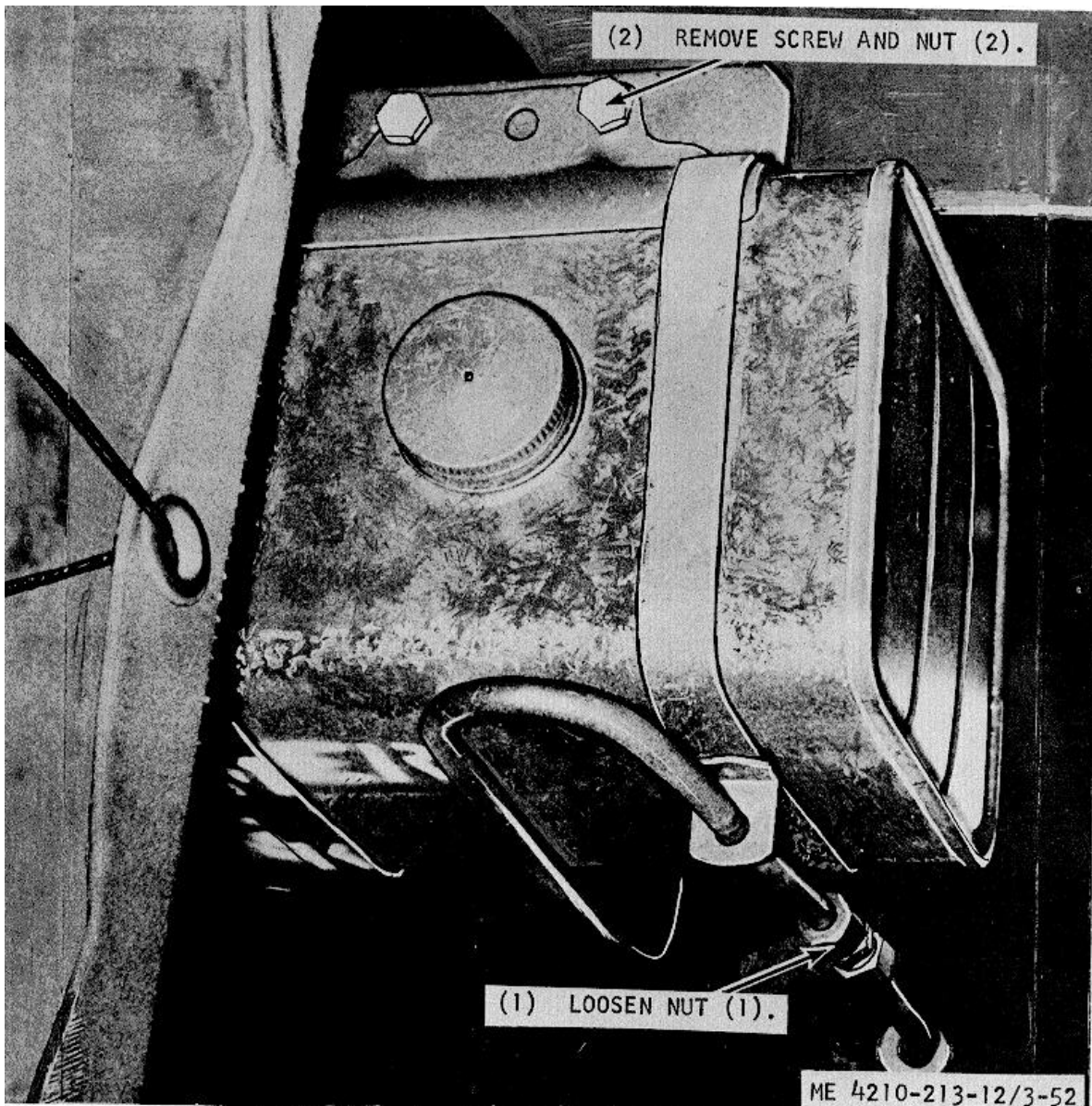

Figure 3-52. Oil tank and lines, removal and installation.

APPENDIX A REFERENCE

A-1. Fire Protection

TM -315

Firefighting and Rescue Operations In Theaters of Operation.

A-2. Lubrication

LO 9-2320-209-12

Lubrication Orders.

A-3. Maintenance

TM 9-2320-209-10

TM 9-2320-209-20

TM 9-2320-209-20P

Operator's manual for 21/a ton 6 x 6 chassis truck.

Organizational maintenance manual for 21/2 ton 6 x 6 chassis truck.

Organizational maintenance repair parts and special tool lists for
2-/2 ton 6 x 6 chassis truck.

TM 9-6140-200-15

Operation and Organizational, Field, and Depot Maintenance:
Storage Batteries Lead-Acid Type.

A-4. Supply Publications

SC 4210-93-C-E04

SC 4210-93-C-E05

SC 4210-93-C-E09

Firefighting Equipment Set, Brush.

Firefighting Equipment Set, Structural.

Firefighting Equipment Set, Crash.

A-5. Preventative Maintenance

TM 5-687

Repairs and Utilities; Fire Protection Equipment and Appliances;
Inspections, Operations, and Preventive Maintenance.

APPENDIX B

BASIC ISSUE ITEMS LIST

Section I. INTRODUCTION

B-1. Scope This appendix lists items which accompany the truck, fire fighting or are required for installation, operation, or operator's maintenance.

B-2. General This Basic Issue Items List is divided into the following sections:

a. *Basic Issue Items-Section II.* A list of items which accompany the truck, fire fighting or are required for the installation, operation, or operator's maintenance.

b. *Maintenance and Operating Supplies, Section III.* A listing of maintenance and operating supplies required for initial operation.

B-3. Explanation of Column.

The following provides an explanation of columns in the tabular list of Basic Issue Items, section II.

a. Source, Maintenance, and Recoverability Codes (SMR), Column (1).

Note

Common hardware items known to be readily available in Army supply will be assigned maintenance codes only. Source codes, recoverability codes, and quantity authorized will not be assigned to this category of items.

(1) Source Code, indicates the selection status and source for the listed item. Source codes are:

<i>Code</i>	<i>Explanation</i>
P	Applied to repair parts which are stocked in or supplied from GSA/DSA or Army supply system, and authorized for use at indicated maintenance categories.
M	Applied to repair parts which are not procured or stocked but are to be manufactured at indicated maintenance categories.
A	Applied to assemblies which are not procured or stocked as such, but made up of two or more units, each of which

carry individual stock numbers and descriptions and are procured and stocked and can be assembled by units at indicated maintenance categories.

X Applied to parts and assemblies which are not procured or stocked, the mortality of which is normally below that of the applicable end item, and the failure of which should result in retirement of the end item from the supply system.

X1 Applied to repair parts which are not procured or stocked, the requirement for which will be Applied by use of the next higher assembly or components X2 Applied to repair parts which are not stocked. The indicated maintenance category requiring such repair parts will attempt to obtain them through cannibalization; if not obtainable through cannibalization, such repair parts will be requisitioned with supporting justification through normal supply channels.

C Applied to repair parts authorized for local procurements. If not obtainable from local procurement, such repair parts will be requisitioned through normal supply channels with a supporting statement of nonavailability from local procurement.

G Applied to major assemblies that are procured with PEMA (Procurement Equipment Missile Army) funds for initial issue only to be used as exchange assemblies at DSU and GSU level or returned to depot supply level.

(2) Maintenance Code, indicates the lowest category of maintenance authorized to install the listed item. The maintenance level codes are:

<i>Code</i>	<i>Explanation</i>
C	Operator/crew
O	Organizational maintenance
F	Direct support maintenance

(3) Recoverability Code, indicates whether unserviceable items should be

turned for recovery or salvage. Items not coded are expendable.

Recoverability codes are:

<i>Code</i>	<i>Explanation</i>
R	Applied to repair parts and assemblies which are economically repairable at DSU and GSU activities and are normally furnished by supply on an exchange basis.
T	Applied to high dollar value recoverable repair parts which are subject to special handling and are issued on an exchange basis. Such repair parts are normally repaired or overhauled at depot maintenance activities.
U	Applied to repair parts specifically selected for salvage by reclamation units because of precious metal content, critical materials, high dollar value reusable casings and castings.

b. Federal Stock Number, Column (2). This column indicates the Federal stock number for the item.

c. Description, Column (3). This column indicates the Federal item name and any additional description of the item required. A part number or other reference number is followed by the applicable five-digit Federal supply code for manufacturers in parentheses. Repair parts quantities included in kits, sets, and assemblies are shown in front of the repair part name.

d. Unit of Issue, Column (4). This column indicates the unit used as a basis for issue, e.g., ea. pr, ft. yd, etc.

e. Quantity Incorporated in Unit rack, Column (5). This column indicates the actual quantity contained in the unit pack.

f. Quantity Incorporated in Unit, Column (6). This column indicates the quantity of the item used in the functional group.

g. Quantity Furnished With Equipment, Column (7). This column indicates the quantity of an item furnished with the equipment.

h. Quantity Authorized, Column (8). This column indicates the quantity of an item authorized the operator/crew to have on hand or to obtain as required. As required items are indicated with an-asterisk.

i. Illustration, Column (9). This column is divided as follows:

(1) *Figure Number, column (9a).* Indicates the figure number of the illustration in which the item is shown.

(2) *Item Number, column (9b).* Indicates the callous number used to reference the item in the illustration.

B 4. Explanation of Columns in the Tabular list of Maintenance and Operating Supplies-Section III

a. Component Application, Column (1). This column identifies the component application of each maintenance or operating supply item.

b. Federal Stock Number, Column (2). This column indicates the Federal stock number for the item and will be used for requisitioning purposes.

c. Description, Column (3). This column indicates the item and brief description.

d. Quantity Required for Initial Operation, Column (4). This column indicates the quantity of each maintenance or operating supply item required for initial operation of the equipment.

e. Quantity Required for 8 Hours Operation, Column (5). This column indicates the estimated quantities required for an average eight hours of operation.

f. Notes, Column (6). This column indicates informative notes keyed to data appearing in a preceding column.

B-5. Abbreviations

<i>Abbreviations</i>	<i>Explanation</i>
ea	each

(1)	(2)	(3)	(4)	(5)	(6)	(7)	(8)	(9)	
SMR Code	Federal stock number	Description	Unit of issue	Qty inc in unit pack	Qty inc in unit	Qty furn with equip	Qty auth	(a) Figure No.	(b) Item No.
<p>Note. Disregard the Basic Items of Section I, Appendix II, TM 9-2320-209-10.</p> <p>31 BASIC ISSUE ITEMS, MANUFACTURER INSTALLED</p> <p>3100 Basic Issue Items, Manufacturer or Depot Installed</p>									
PC	5100-7724-4142	BAG TOOL SACHEL	EA			1	1		
PC	4901-0880-06252	GAGE AND HOSE ASSY. (Tire Inflation 20 ft. Hose)	EA			1	1		
PC	5120-233-7398	PLIERS, COMB, SLIP JOINT, 10 in. lg. w/cutter	EA			1	1		
PC	5120-234-8913	SCREWDRIVER, CROSS TIP, Phillips No. 2, 4 in. blade	EA			1	1		
PC	2520-224-88716	SCREWDRIVER, CROSS TIP, Phillips No. 1, 3 in. blade	EA			1	1		
PC	2520-222-8052	SCREWDRIVER, FLAT TIP, 8 in. blade	EA			1	1		
PC	5120-449-8083	WRENCH, OPEN END, ADJUSTABLE, 10 in.	EA			1	1		
		DA TECHNICAL MANUAL TM 5-4210-213-12 Operator's And Organizational Maintenance Manual Includes LO 5-4210-213-12	EA			1	1		
		DA TECHNICAL MANUAL TM 9-2320-209-10 Operator's Manual (M45A2 Chassis) Includes LO 9-2320-209-12	EA			1	1		
	7510-889-4904	EQUIPMENT LOG BOOK BINDER (Forms as listed in TM 38-750 for Item No. 770140 are to be provided with this binder.)	EA			1	1		
<p>32 BASIC ISSUE ITEMS, TROOP INSTALLED</p> <p>3200 Basic Issue Items, Troop Installed or Authorized</p>									
PC	5120-243-2419	BAR, SOCKET WRENCH HANDLE	EA				1		
PC	2240-333-0030	CHAIN ASSEMBLY, TIRE, DUAL	PR				1		
PC	2240-333-0024	CHAIN ASSEMBLY, TIRE, SINGLE	PR				1		
PC	4240-202-4858	EXTINGUISHER, FIRE, CO ² , 15 lb. (Applicable when not supplied with Fire Fighting Equipment Set, Brush Fires.)	EA				2		
PC	5120-863-7742	HANDLE, JACK	EA				1		
PC	5120-243-2419	JACK, HYDRAULIC	EA				1		
AFC	5120-083-2844	WHEEL, W/TIRE AND TUBE ASSEMBLY, SPARE Composed of:	EA				1		
	2640-052-0944	1 Ea. Cap, Valve							
	2640-269-7383	1 Ea. Inner Tube							
	2640-262-8677	1 Ea. Tire, Pneumatic, 8 ply, NDCC, 9.00-20							
	2840-060-2229	1 Ea. Valve Core							
	2850-738-6621	1 Ea. Wheel and Rim With Ring Assembly							

(1)	(2)	(3)	(4)	(5)	(6)	(7)	(8)	(9)	
SME Code	Federal stock number	Description	Unit of issue	Qty inc in unit pack	Qty inc in unit	Qty furn with equip	Qty auth	(a) Figure No.	(b) Item No.
PC	5120-493-3152	WRENCH, SOCKET, Wheel Stud, Nut, Double Head Socket, 1 1/2 Hex Opening, 13/16 Square Opening, 14 7/8 inches Long.	EA				1		

Section III. MAINTENANCE AND OPERATING SUPPLIES

Item	Component application	Federal stock number	Description	Quantity required for initial operation	Quantity required for 8 hours operation	Notes
1	Transmission Assy, Fire Pump	9150-577-5845 9150-257-5442	Oil, Lubricating GO 90 or (2) GOS (2)	2 qt 2 qt	(1) (1)	(1) See current LO for grade application and replenishment intervals. (2) See C9100 IL for additional data and requisitioning procedure.
2	Tank, Priming Pump		Oil, Lubricating	6 qt	(1)	
3	Grease Points	9150-190-0904(2) 4210-223-9877	Grease, Automotive and Artillery: 1 lb. can as follows: GAA	As req.	(1)	
4	Foam Tank		Foam Liquid, Fire Extinguishing 5 gal. pail Fed Spec O-F-555	40 gal		

Note. See Section III of Appendix II of TM 9-2320-209-10, for Maintenance and Operating Supplies. Applicable to the 2½ ton, 6x6, Model M45A2 Truck Chassis.

APPENDIX C

MAINTENANCE ALLOCATION CHART

Section I. INTRODUCTION

C-1. General

a. *Section I*, provides a general explanation of all maintenance and repair functions authorized at various maintenance levels.

b. *Section II*, designates overall responsibility for the performance of maintenance operations on the identified end item or component. The implementation of the maintenance tasks upon the end item or component will be consistent with the assigned maintenance operations.

c. *Section III*, lists the special tools and test equipment required for each maintenance operation as referenced from section II.

d. *Section IV*, contains supplemental instructions, explanatory notes and/or illustrations required for a particular maintenance function.

C-2. Explanation of Columns in Section II

a. *Functional Group Number*. The functional group is a numerical group set up on a functional basis. The applicable functional grouping indexes obtained from TB 750-981 (Functional Grouping Codes) are listed on the MAC in the appropriate numerical sequence. These indexes are normally set up in accordance with their function and proximity to each other.

b. *Component Assembly Nomenclature*. This column contains a brief description of the components of each functional group.

c. *Maintenance Operations and Maintenance Levels*. This column lists the various maintenance operations (A through J) and indicates the lowest maintenance level authorized to perform these operations. The symbol designations for the various maintenance levels are as follows:

C - Operator or crew

O - Organizational maintenance
F - Direct support maintenance
H - General support maintenance
D - Depot maintenance

The maintenance operations are defined as follows:

- A - Service: Operations required periodically follows:
A - Service: Operations required periodically to keep the item in proper operating condition, i.e., to clean, preserve, drain, paint, and replenish fuel, lubricants, hydraulic, and deicing fluids, or compressed air supplies.
- B - Adjust: Adjust two or more components of an electrical or mechanical system so that their functions are properly synchronized or adjusted.
- C - Align: To adjust specified variable elements of an item to bring to optimum performance.
- D - Calibrate Determine, check, or rectify the graduation of an instrument, weapon, or weapons system or components of a weapons system.
- E - Inspect: Verify serviceability and detect incipient electrical or mechanical failure by close visual examination.
- F - Test: Verify serviceability and detect incipient electrical or mechanical failure by measuring the mechanical or electrical characteristics of the item and comparing those characteristics with authorized standards. Tests will be made commensurate with test procedures and with calibrated tools and/or test equipment referenced in the MAC.
- G - Replace: Substitute serviceable components, assemblies and subassemblies for

unserviceable counterparts or remove and install the same item when required for the performance of other maintenance operation.

H-Repair: Restore to a serviceable condition by replacing unserviceable parts or by any other action required using available tools, equipment and skills-to include welding, grinding, riveting, straightening, adjusting and facing.

I-Overhaul: Restore an item to a completely serviceable condition (as prescribed by serviceable standards developed and published by the commodity commands) by employing techniques of "Inspect and Repair Only As Necessary" (IROAN). Maximum use of diagnostic and test equipment is combined with minimum disassembly during overhaul. "Overhaul" may be assigned to any level of maintenance except organizational, provided the time, tools, equipment, repair parts authorization, and technical skills are available at that level. Normally, overhaul as applied to end items, is limited to depot maintenance level.

J-Rebuild: Restore to a condition comparable to new by disassembling to determine the condition of each component part and reassembling using serviceable, rebuilt, or new assemblies, subassemblies, and parts.

d. *Reference Note.* Their column, subdivided into columns K and L, is provided for referencing the Special Tool and Test Equipment Requirements (sec. III) and remarks (sec. IV) that may be associated with maintenance operations (sec. II) .

C-3. Explanation of Columns in Section III

a. *Reference Code.* This column consists of a number and a letter separated by a dash. The number reference the T and TE requirements column on the MAC. The letter represents the specific maintenance operation the item is to be used with. The letter is representative of columns A through J on the MAC.

b. *Maintenance Level.* This column shows the lowest level of maintenance authorized to use the special tool or test equipment.

c. *Nomenclature.* This column lists the name or identification of the tool or test equipment.

d. *Tool Number.* This column lists the manufacturer's code and part number, or Federal Stock Number of tools and test equipment.

C-4. Explanation of Columns in Section IV

a. *Reference Code.* This column consists of two letters separated by a dash, both of which are references to section II. The first letter references column L and the second letter references a maintenance operation, columns A through J.

b. *Remarks.* This column lists information pertinent to the maintenance operation being performed, as indicated on the MAC section II.

Section II. MAINTENANCE ALLOCATION CHART

Functional group number	Component assembly nomenclature	Essentiality	Maintenance operations						Maintenance levels				Note Reference	
			A	B	C	D	E	F	G	H	I	J	K	L
			Service	Adjust	Align	Calibrate	Inspect	Test	Replace	Repair	Overhaul	Rebuild	T&TE reqmt	Remarks
03	FUEL SYSTEM							0						
0312	Throttle Controls													
05	COOLING SYSTEM													
0501	Heat Exchanger							0						
0503	Water Manifolds; Gaskets							0						
	Fittings, hoses; clamps							0						
06	ELECTRICAL SYSTEM													
0607	Instrument Panel													
	Switches; gages; leads, electrical							0						
	Housing assembly, instrument							0	0					

Functional group number	Component assembly nomenclature	Essentiality	Maintenance operations						Maintenance levels			Note Reference		
			A	B	C	D	E	F	G	H	I	J	K	L
			Service	Adjust	Align	Calibrate	Inspect	Test	Replace	Repair	Overhaul	Rebuild	T&TE rgmt	Remarks
	Lamp							O/C						
0608	Miscellaneous Items													
	Receptacle, Slave; Switches; Fuses; circuit breakers; terminal boards							O						
0609	Lights							O	O					
0610	Sending Units							O						
0611	Siren							O	O					
	Solenoid; switches							O						
0612	Batteries													
	Box assembly							O	O					
	Cables							O						
0613	Chassis Wiring Harness													
	Harness, wiring							F	O					
0615	Radio Interference Suppression Components							O	O					
12	BRAKES													
1208	Air Brake System													
	Bracket assembly							O						
15	FRAME													
1501	Frame Assembly							F						
	U bolt assembly							F	F					
	Sill, tank							F						
18	BODY													
1812	Special Purpose Bodies													
	Bed assemblies; bracket assembly; door assemblies							O	O					
	Compartment assemblies							F	O					
	Mounting assembly, ladder; rear end assembly, retainer assemblies							O	O					
22	ACCESSORY ITEMS													
2202	Accessory Items													
	Heater, personnel							O	O					
2207	Winterization Equipment													
	Box assembly, oil pan							O						
	Exchangers, heat, battery box and oil pan							O	O					
2210	Data Plates & Instruction Holders													
	Plates, data							F						
	Plates, instruction							O						
40	ELECTRIC MOTORS													
4000	Motor, Electric							O/C		O	F			
4006	Starting & Protective Devices													
	Relay; switches; solenoids									O				
4019	Radio Interference Suppression									O				
47	GAGES													
4701	Instruments (Speed & Distance)													
	Tachometer; gear; shaft ay									O				
4702	Gages, Lines, Fittings									O				
55	PUMPS													
5500	Pump Assembly									F	F			
	Pump primer									O	F			

Functional group number	Component assembly nomenclature	Essentiality	Maintenance operations						Maintenance levels					Note Reference		
			A	B	C	D	E	F	G	H	I	J	K	L		
			Service	Adjust	Align	Calibrate	Inspect	Test	Replace	Repair	Overhaul	Rebuild	T&TE reqmt	Remarks		
5501	Shafts, Rotors; Impellers															
	Shaft ay, primer							F		F						
	Bearings; seals; impeller; vane, rotor; shaft							F								
5505	Suction and/or Discharge Assembly															
	Head assemblies							F		F						
	Stem ay; hoses; knob							O								
	Strainer		O/C					O								
	Valves							F		F						
5507	Pump Drive															
	Drive unit							F		F						
	Lever, ay; clutch; shaft drive, power															
	Take-off							O		O						
	Universal							O		O						
76	FIRE FIGHTING EQUIPMENT COMPONENTS															
7601	Foam Making Units							O		O						
	Tank ay, foam							O		O						
7611	Water and Foam Tanks and Piping															
	Tanks, water		O/C					F		F						
	Adapters; fittings, valves							O		O						
	Rods, valve operating and piping							O		F						
7613	Reel Assembly		O/C					O		F						
	Chain assembly															

Section III. SPECIAL TOOL AND SPECIAL TEST EQUIPMENT REQUIREMENTS

Reference code	Maintenance level	Nomenclature	Tool number
None Required			

Section IV. REMARKS

Reference code	Remarks
None Required	

INDEX

	Paragraph	Page		Paragraph	Page
Air system.....	3-46	3-16	Inspecting and servicing equipment.....	2-3	2-1
Air tank tubing and fittings.....	3-47	3-16	Installation:		
			Of separately packed components.....	2-4	2-2
Basic issue tools and equipment.....	3-2	3-1	Of setting up instructions.....	2-5	2-2
Battery box.....	3-43	3-15	Instruction installation or		
Axe, bars, cutter.....	3-38	3-14	setting; up.....	2-5	2-2
First aid, hand lantern, fitting			Interference suppression components.....	3-22	3-10
compartment	3-40	3-14			
Fire extinguisher	3-29	3-12	Ladder support assemblies.....	3-32	3-13
Circuit breakers.....	3-57	3-28	Lubrication:		
Compartment accessory doors.....	3-67	3-28	Detailed information.....	3-4	3-1
Components:			General information	3-3	3-1
Installation of separately packed			Movement:		
comp	2-4	2-2	Dismantling for.....	2-6	2-2
Interference suppression.....	3-20	3-10	Reinstallation after.....	2-7	2-2
Replacement of suppression.....	3-23	3-10	Models, difference in	1-5	1-5
Testing of radio interference					
suppression	3-24	3-12	Oil pressure sending unit.....	3-55	3-28
Controls and instruments.....	2-9	2-2	Operation:		
Controls and instruments, general.....	2-8	2-2	In dusty or sandy areas.....	2-20	2-24
			In extreme cold	2-18	2-6
Daily preventive maintenance	3-6	3-1	In extreme heat.....	2-19	2-24
Data, identification and tabulated.....	1-4	1-3	In high altitudes.....	2-23	2-24
Description.....	1-3	1-1	In salt water areas.....	2-22	2-24
Difference in models	1-5	1-5	Under rainy or humid conditions.....	2-21	2-24
Dismantling for movement	2-6	2-2	Under usual conditions.....	2-17	2-6
Draining and flushing details	2-15	2-6	Operator's maintenance, general.....	3-8	3-9
Electrical system, general	3-48	3-27	Preventive maintenance services:		
Extinguisher compartment			Daily	3-6	3-1
accessories.....	3-39	3-14	General.....	3-5	3-1
Extinguisher, fire	2-24	2-24	Quarterly.....	3-7	3-9
			Pump and hose reel assemblies.....	3-41	3-14
Foam nozzle retainer	3-33	3-13	Pump, water, priming and filling		
Forms, record and report.....	1-2	1-1	tanks	2-13	2-6
Fuel system	3-44	3-15	Pumping.....	2-14	2-6
General lubrication information	3-3	3-1	Quarterly preventive maintenance		
General methods used to attain			services	3-7	3-9
proper suppression.....	3-21	3-10			
Handrails and brackets.....	3-28	3-12	Radio interference suppression		
Heat exchanger.....	3-94	3-57	general	3-20	3-10
Heater, oil pan adapter.....	3-42	3-14	Rear step	3-30	3-13
Hose bed:			Record and report forms.....	1-2	1-1
Assemblies	3-26	3-12	Replacement of suppression		
Partition	3-27	3-12	components.....	3-23	3-10
Hose retainer	3-34	3-13			
			Scope.....	1-1	1-1
Identification and tabulated data.....	1-4	1-3	Shovel, brackets	3-31	3-13
			Siren and flasher light	3-50	3-28
Detailed lubrication	3-4	3-1	Information: Siren solenoid relay	3-54	3-28
General lubrication.....	3-3	3-1	Special tools and equipment	3-1	3-1

	Paragraph	Page
Splash guards.....	3-36	3-13
Spotlight.....	3-51	3-28
Starting	2-11	2-3
Steps, folding.....	3-35	3-13
Stopping.....	2-12	2-3
Suppression, general methods used to attain proper	3-21	3-10
Tabulated data.....	1-4	1-3
Temperature sending unit.....	3-56	3-28
Testing of radio interference.....		
suppression components.....	3-24	3-12

	Paragraph	Page
Throttle control and linkage.....	3-46	3-15
Troubleshooting:		
General.....	3-9	3-9
Subsequent paragraphs.....	3-10	3-9,
	3-19	3-10
Underhood lights.....	3-53	3-28
Unloading equipment	2-1	2-1
Unpacking equipment.....	2-2	2-1
Warning light.....	3-52	3-28
Wiring	3-49	3-27

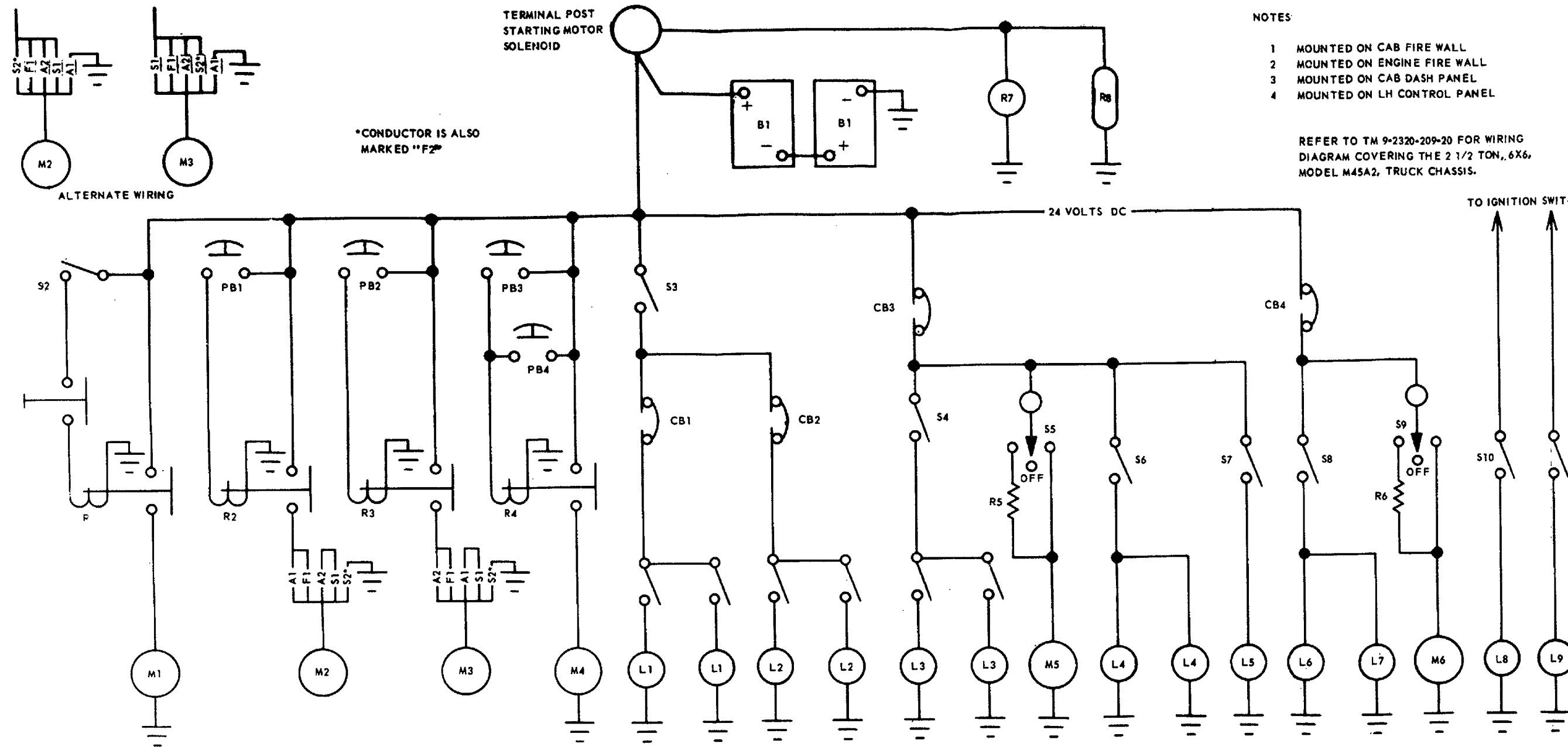

NOTES

- 1 MOUNTED ON CAB FIRE WALL
- 2 MOUNTED ON ENGINE FIRE WALL
- 3 MOUNTED ON CAB DASH PANEL
- 4 MOUNTED ON LH CONTROL PANEL

REFER TO TM 9-2320-209-20 FOR WIRING DIAGRAM COVERING THE 2 1/2 TON, 6X6, MODEL M45A2, TRUCK CHASSIS.

SYMBOLS AND DESCRIPTION

B1	BATTERY, STORAGE, 12-VOLTS (2 REQ.)
CB1	CIRCUIT BREAKER, 15 AMP. (NOTE 1)
CB2	CIRCUIT BREAKER, 15 AMP. (NOTE 1)
CB3	CIRCUIT BREAKER, 15 AMP. (NOTE 1)
CB4	CIRCUIT BREAKER, 15 AMP. (NOTE 1)
L1	SPOTLIGHTS, FRONT (2 REQ.)
L2	SPOTLIGHTS, REAR (2 REQ.)
L3	LIGHT, ENGINE, UNDERHOOD (2 REQ.)
L4	LIGHT, INSTRUMENT PANEL (2 REQ.)
L5	LIGHT, CONTROL PANEL
L6	WARNING LIGHT
L7	LIGHT, SIREN
L8	LIGHT, INDICATOR, ENG. TEMPERATURE
L9	LIGHT, INDICATOR, ENG. OIL PRESSURE
M1	MOTOR, PRIMING PUMP
M2	MOTOR, RH HOSE REEL
M3	MOTOR, LH HOSE REEL
M4	MOTOR, SIREN
M5	MOTOR, HEATER
M6	MOTOR, DEFROSTER
PB1	SWITCH, PUSH BUTTON RH HOSE REEL
PB2	SWITCH, PUSH BUTTON LH HOSE REEL
PB3	SWITCH, PUSH BUTTON, HAND, SIREN
PB4	SWITCH, PUSH BUTTON, FOOT, SIREN
R1	RELAY, SOLENOID, PRIMER MOTOR
R2	RELAY, SOLENOID, RH HOSE REEL
R3	RELAY, SOLENOID, LH HOSE REEL
R4	RELAY, SOLENOID, SIREN MOTOR
R5	RESISTOR, 25 WATT, 10 OHM (NOTE 2)
R6	RESISTOR, 25 WATT, 10 OHM (NOTE 2)
R7	RECEPTACLE, BATTERY CHARGING (ARMY)
R8	RECEPTACLE, BATTERY CHARGING (AIR FORCE)
S1	SWITCH, PULL, PRIMER VALVE (NOTE 4)
S2	SWITCH, TOGGLE, PRIMER VALVE (NOTE 4)
S3	SWITCH, TOGGLE, SPOTLIGHTS (NOTE 3)
S4	SWITCH, TOGGLE, ENGINE LIGHTS (NOTE 3)
S5	SWITCH, TOGGLE, HEATER MOTOR (NOTE 3)
S6	SWITCH, TOGGLE, INSTRUMENT PANEL LIGHTS
S7	SWITCH, TOGGLE, CONTROL PANEL LIGHT
S8	SWITCH, TOGGLE, LIGHTS-WARNING & SIREN (NOTE 3)
S9	SWITCH, TOGGLE, DEFROSTER MOTOR (NOTE 3)
S10	SWITCH, THERMOSTATIC, ENG. TEMP. LIGHT (NORMALLY OPEN-CLOSES WHEN COOLANT EXCEEDS 200° F.)
S11	SWITCH, PRESSURE, ENG. OIL PRESS. IND. LIGHT (NORMALLY CLOSED-OPENS WHEN PRESSURE IS ABOVE 15 PSIG.)

ME 4210-213-12/1-3

Figure 1-3. Wiring Diagram.

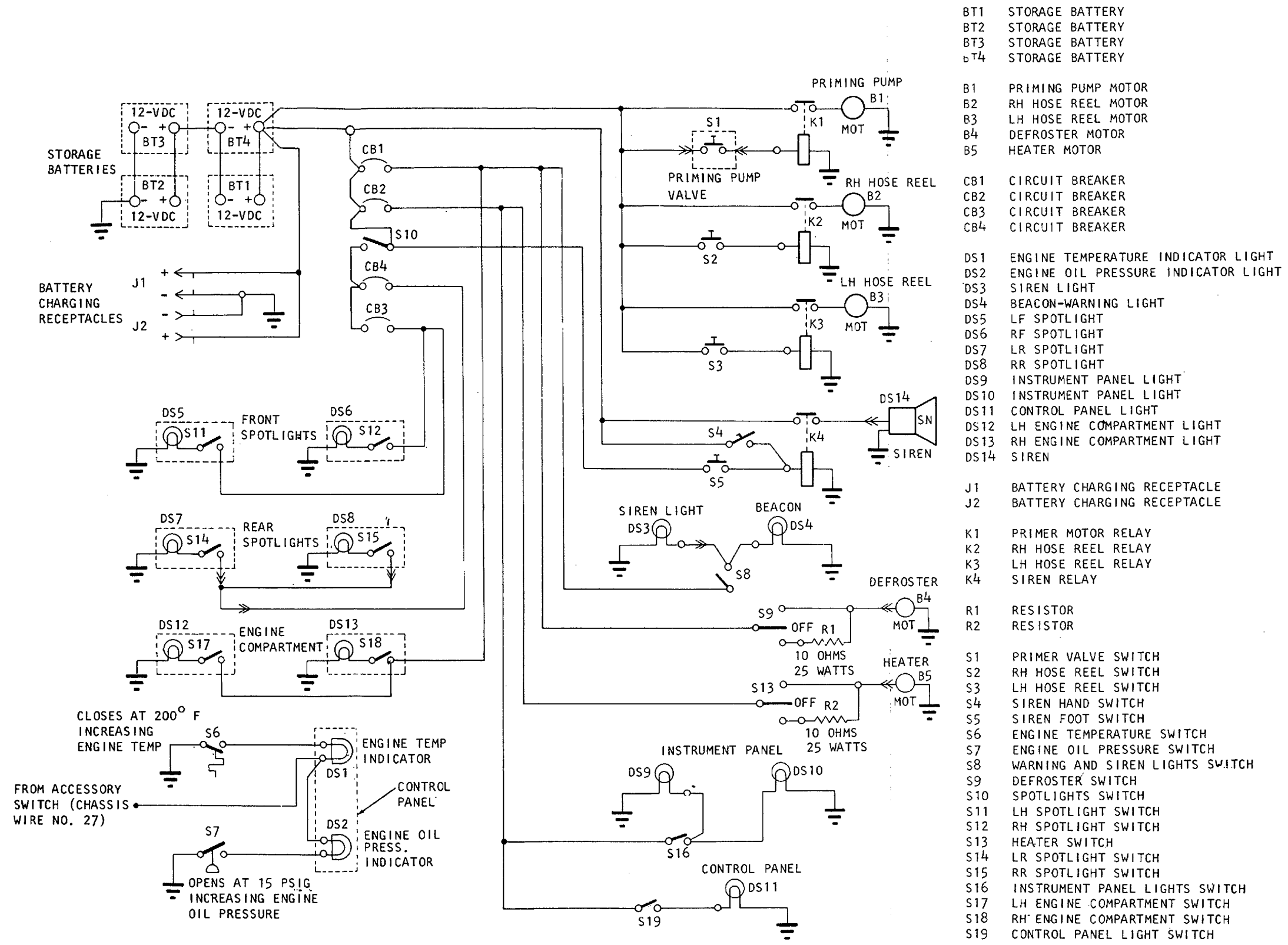

- BT1 STORAGE BATTERY
- BT2 STORAGE BATTERY
- BT3 STORAGE BATTERY
- BT4 STORAGE BATTERY

- B1 PRIMING PUMP MOTOR
- B2 RH HOSE REEL MOTOR
- B3 LH HOSE REEL MOTOR
- B4 DEFROSTER MOTOR
- B5 HEATER MOTOR

- CB1 CIRCUIT BREAKER
- CB2 CIRCUIT BREAKER
- CB3 CIRCUIT BREAKER
- CB4 CIRCUIT BREAKER

- DS1 ENGINE TEMPERATURE INDICATOR LIGHT
- DS2 ENGINE OIL PRESSURE INDICATOR LIGHT
- DS3 SIREN LIGHT
- DS4 BEACON-WARNING LIGHT
- DS5 LF SPOTLIGHT
- DS6 RF SPOTLIGHT
- DS7 LR SPOTLIGHT
- DS8 RR SPOTLIGHT
- DS9 INSTRUMENT PANEL LIGHT
- DS10 INSTRUMENT PANEL LIGHT
- DS11 CONTROL PANEL LIGHT
- DS12 LH ENGINE COMPARTMENT LIGHT
- DS13 RH ENGINE COMPARTMENT LIGHT
- DS14 SIREN

- J1 BATTERY CHARGING RECEPTACLE
- J2 BATTERY CHARGING RECEPTACLE

- K1 PRIMER MOTOR RELAY
- K2 RH HOSE REEL RELAY
- K3 LH HOSE REEL RELAY
- K4 SIREN RELAY

- R1 RESISTOR
- R2 RESISTOR

- S1 PRIMER VALVE SWITCH
- S2 RH HOSE REEL SWITCH
- S3 LH HOSE REEL SWITCH
- S4 SIREN HAND SWITCH
- S5 SIREN FOOT SWITCH
- S6 ENGINE TEMPERATURE SWITCH
- S7 ENGINE OIL PRESSURE SWITCH
- S8 WARNING AND SIREN LIGHTS SWITCH
- S9 DEFROSTER SWITCH
- S10 SPOTLIGHTS SWITCH
- S11 LH SPOTLIGHT SWITCH
- S12 RH SPOTLIGHT SWITCH
- S13 HEATER SWITCH
- S14 LR SPOTLIGHT SWITCH
- S15 RR SPOTLIGHT SWITCH
- S16 INSTRUMENT PANEL LIGHTS SWITCH
- S17 LH ENGINE COMPARTMENT SWITCH
- S18 RH ENGINE COMPARTMENT SWITCH
- S19 CONTROL PANEL LIGHT SWITCH

Figure 1-4. Wiring diagram (FT-500).
1-4

By Order of the Secretary of the Army:

HAROLD K. JOHNSON,
General, United States Army,
Chief of Staff.

Official:

KENNETH G. WICKHAM,
Major General, United States Army,
The Adjutant General.

Distribution:

To be distributed in accordance with DA Form 12-25, Section I, Organizational Maintenance requirements for Equipment: Fire Fighting.

★ U.S. GOVERNMENT PRINTING OFFICE: 1991 0 - 281-486 / 43639

THE METRIC SYSTEM AND EQUIVALENTS

WEIGHT MEASURE

1 Centimeter = 10 Millimeters = 0.01 Meters = 0.3937 Inches
 1 Meter = 100 Centimeters = 1000 Millimeters = 39.37 Inches
 1 Kilometer = 1000 Meters = 0.621 Miles

WEIGHTS

1 Gram = 0.001 Kilograms = 1000 Milligrams = 0.035 Ounces
 1 Kilogram = 1000 Grams = 2.2 lb.
 1 Metric Ton = 1000 Kilograms = 1 Megagram = 1.1 Short Tons

LIQUID MEASURE

1 Milliliter = 0.001 Liters = 0.0338 Fluid Ounces
 1 Liter = 1000 Milliliters = 33.82 Fluid Ounces

SQUARE MEASURE

1 Sq. Centimeter = 100 Sq. Millimeters = 0.155 Sq. Inches
 1 Sq. Meter = 10,000 Sq. Centimeters = 10.76 Sq. Feet
 1 Sq. Kilometer = 1,000,000 Sq. Meters = 0.386 Sq. Miles

CUBIC MEASURE

1 Cu. Centimeter = 1000 Cu. Millimeters = 0.06 Cu. Inches
 1 Cu. Meter = 1,000,000 Cu. Centimeters = 35.31 Cu. Feet

TEMPERATURE

$5/9(^{\circ}\text{F} - 32) = ^{\circ}\text{C}$
 212° Fahrenheit is equivalent to 100° Celsius
 90° Fahrenheit is equivalent to 32.2° Celsius
 32° Fahrenheit is equivalent to 0° Celsius
 $9/5^{\circ}\text{C} + 32 = ^{\circ}\text{F}$

APPROXIMATE CONVERSION FACTORS

TO CHANGE	TO	MULTIPLY BY
Inches	Centimeters	2.540
Feet	Meters	0.305
Yards	Meters	0.914
Miles	Kilometers	1.609
Square Inches	Square Centimeters	6.451
Square Feet	Square Meters	0.093
Square Yards	Square Meters	0.836
Square Miles	Square Kilometers	2.590
Acres	Square Hectometers	0.405
Cubic Feet	Cubic Meters	0.028
Cubic Yards	Cubic Meters	0.765
Fluid Ounces	Milliliters	29.573
its	Liters	0.473
arts	Liters	0.946
allons	Liters	3.785
Ounces	Grams	28.349
Pounds	Kilograms	0.454
Short Tons	Metric Tons	0.907
Pound-Feet	Newton-Meters	1.356
Pounds per Square Inch	Kilopascals	6.895
Miles per Gallon	Kilometers per Liter	0.425
Miles per Hour	Kilometers per Hour	1.609

TO CHANGE	TO	MULTIPLY BY
Centimeters	Inches	0.394
Meters	Feet	3.280
Meters	Yards	1.094
Kilometers	Miles	0.621
Square Centimeters	Square Inches	0.155
Square Meters	Square Feet	10.764
Square Meters	Square Yards	1.196
Square Kilometers	Square Miles	0.386
Square Hectometers	Acres	2.471
Cubic Meters	Cubic Feet	35.315
Cubic Meters	Cubic Yards	1.308
Milliliters	Fluid Ounces	0.034
Liters	Pints	2.113
Liters	Quarts	1.057
ers	Gallons	0.264
ms	Ounces	0.035
ograms	Pounds	2.205
Metric Tons	Short Tons	1.102
Newton-Meters	Pounds-Feet	0.738
Kilopascals	Pounds per Square Inch	0.145
ometers per Liter	Miles per Gallon	2.354
ometers per Hour	Miles per Hour	0.621

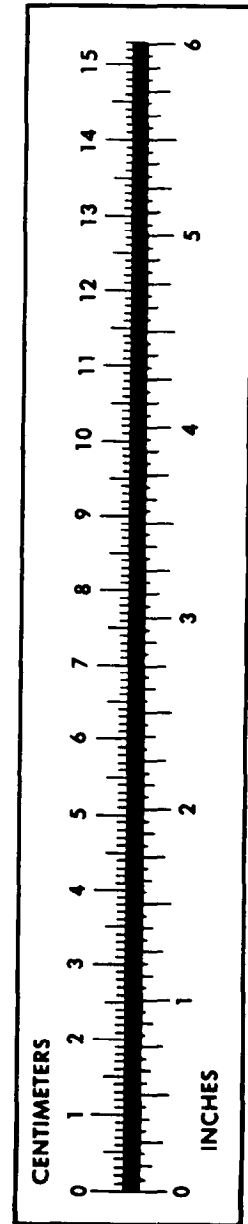

PIN: 005830-000